

www.teamxray.com



XRAY
THE ART OF PERFORMANCE



SET-UP BOOK

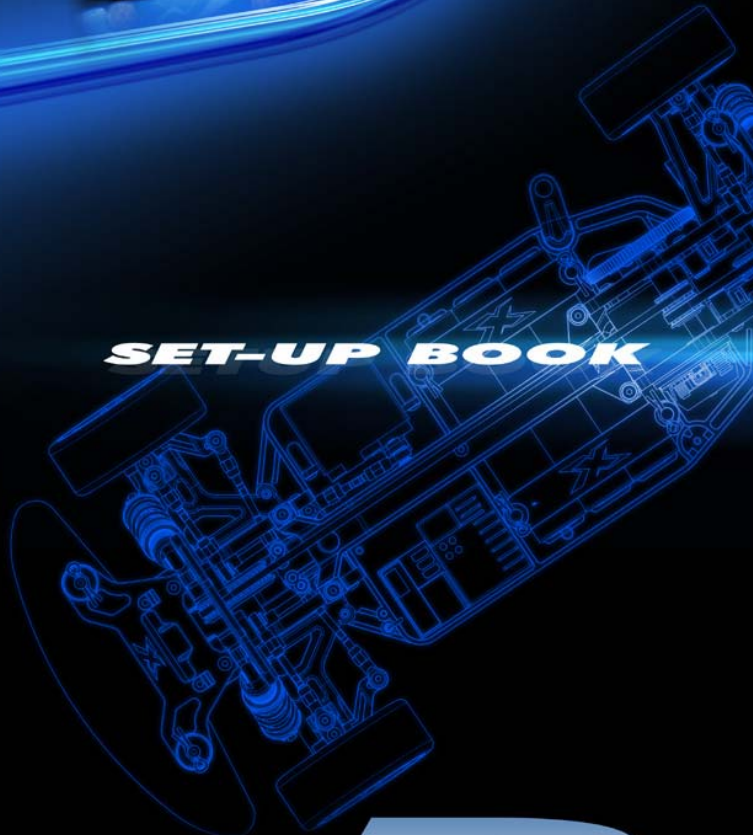

XRAY MODEL RACING CARS
P.O. BOX 103
911 50 TRENCÍN
SLOVAKIA, EUROPE
PHONE: ++421 905 402724
support@teamxray.com

TTR
RAYCER

1/10 HIGH COMPETITION ELECTRIC TOURING CAR

Introduction	2
Final Adjustments	
Radio Adjustments	3
Speed Control (ESC) Adjustments	3
Connecting the Motor	3
Motor Gearing	3
Rollout	5
Differential Adjustment	5
Tightening the Differentials	6
Loosening the Differentials	6
Building the Differentials	6
Checking the Differential Slippage	7
Checking the Differential Action	7
Tightening the Differential	7
Loosening the Differential	7
Breaking In the Differentials	7
Adjusting the Front Differential	7
Adjusting the Rear Differential	8
One-Way Pulley (Available Option)	9
Looser One-Way Pulley	9
Tighter One-Way Pulley	9
One-Way Front Differential (Available Option)	9
Front Solid Axle	10
Shocks	10
Springs	10
XRAY Spring Tensions	11
Spring Preload	11
Shock Position	12
Front Shocks - Upper Mounting Position	12
Front Shocks - Lower Mounting Position	12
Rear Shocks - Upper Mounting Position	13
Rear Shocks - Lower Mounting Position	13
Shock Oil	13
Shock Damping	14
Damping and Shock Pistons	14
Tires, Wheels, and Inserts	15
Tires	15
Inserts	15
Traction Compound	16
Body Aerodynamics	16
Bodies	16
Wings	16
Chassis Setup	
Track-Width	17
Downstops	17
Front Downstops	18
Rear Downstops	18
Ride Height	19
Ride Height and Tires	20
Ride Height and Suspension Settings	20
Ackermann and Steering Throw Symmetry	20

Changing the Ackermann Setting	21
Front Anti-Dive	22
Camber	23
Adjusting Front Camber	23
Front Camber Link Position	23
Adjusting Rear Camber	24
Rear Camber Link Position	24
Caster	24
Changing Caster	25
Toe-In and Toe-Out	25
Adjusting Front Toe-In / Toe-Out	26
Adjusting Rear Toe-In	26
Rear Anti-Squat	27
Rear Roll Center	28
Wheelbase	28
Rear Camber Link Adjustment Balls	29
Anti-Roll Bars (Available Option)	30
Front Anti-Roll Bar	30
Checking Front Anti-Roll Bar Functioning	30
Rear Anti-Roll Bar	31
Checking Rear Anti-Roll Bar Functioning	31
Checking forTweak	31
Checking for Front Tweak	32
Checking for Rear Tweak	33

Chassis Balancing

Chassis Weights	34
Weight Placement	34
Front of Chassis	34
Center of Chassis	34
Rear of Chassis	35
Fake Transponder	35
Mounting the Transponder in Front	35
Mounting the Transponder on the Side	35

Maintenance & Tips

Drive Train	36
Drive Train Binding	36
Belts	36
Belt Tensioner (Available Option)	36
Differentials	36
Suspension	36
Shocks	36
Ball Cups and Shock Ends	37
Bearings	37
Cleaning Bearings	37
Chassis Stiffening	37
Motor	37
Radio Equipment	38
Screws	38
Last-Aid Package	38
Replacement Mounting Hardware	38
Front Wheel Axle Disassembly	38

Car setup, a challenging task, is used to get your car to its maximum performance. While knowledge of your car and knowing the theories of handling dynamics is beneficial, it can be difficult to apply this knowledge because of the inherent complexity in the setup process itself.

Your new T1R touring car with fully independent suspension was designed to have optimum performance at any track, right out of the box. For the top competition we suggest you learn all the best possible setup tips & tricks so the car has the highest possible performance in every racing condition.

We have developed these straight-forward procedures to help you set up your T1R properly and easily. Always follow these procedures step-by-step, in the order presented, and always make sure that you make equal adjustments on both left and right sides of the car.

The setup described here is a good starting point, but you may adjust the settings to better suit different track conditions. Only change one thing at a time so you gain a better understanding of the effect of each change on the car's handling. Remember to document all the changes you make, and the effects they have on your car and lap times.

XRAY publishes new setup information, hot tuning tips, and the latest hoppers for your T1R on the www.teamxray.com website. As a member of www.myTSN.com, XRAY publishes all news at myTSN.com RC portal. As a proud owner of a T1R, you can register your car at myTSN.com and you may post your own setups to the website, either as public or private data, and even link the setups directly to a particular track or event (providing that those are present on myTSN.com).

We have used the following tools and accessories for perfect and optimal adjustment:

- #10 8201 HUDY Set-up Board for 1/10
- #10 8211 HUDY Set-up Board Decal for 1/10
- #10 9300 HUDY Universal Set-up for All 1/10 Touring Cars
- #10 7702 HUDY Chassis Droop Gauge Support Blocks
- #10 7712 HUDY Chassis Droop Gauge -3 to 10 mm
- #10 7715 HUDY Ride Height Gauge

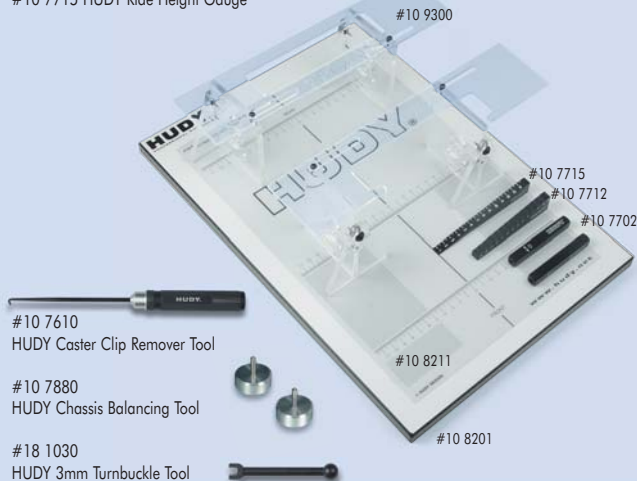

WARNING



The composite material is sensitive to very high temperatures. Prolonged exposure to very high temperatures will damage the composite and may cause it to deform. For example, do not leave the T1R in a sealed car during hot days.



The composite material is also sensitive to prolonged exposure to water. If you race the car in wet conditions, thoroughly dry the chassis after each run; we recommend using compressed air. If water remains in the chassis, the composite material will absorb the water which may result in weakened composite components.

In the event the chassis is exposed to extreme conditions and it becomes slightly distorted (not perfectly flat) there is no need to worry. The unique construction of the car, thanks to the ultra-stiff duraluminum bulkheads and top deck, will negate any tweaking effects so the car will suffer no performance loss.

Final Adjustments

RADIO ADJUSTMENTS

First, remove the servo horn from the steering servo, and disconnect the motor wires (DO NOT let the motor wires touch!), then turn the transmitter on. Next, connect the battery pack and turn on the speed control. Set the steering trim to neutral on your transmitter, then reconnect the servo horn to the steering servo so the steering horn is perpendicular as shown.

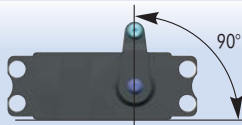

With the steering servo centered, use the transmitter to turn the steering left and right, noting if the wheels turn in the proper direction. If not, change the steering servo direction (servo reverse) on the transmitter and re-center the servo horn on the steering servo if necessary.

Next, examine the car's servo saver. Use the steering link adjustment (between the servo horn and the servo saver) to get the servo saver as centered as possible.

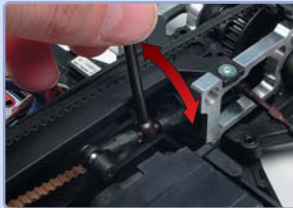

Next, examine the position of the front wheels; they should be pointing straight ahead. If not, adjust the two steering rods equally until the wheels point straight ahead.

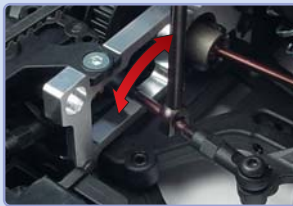

When adjusting the servo, adjust the steering so the steering block does not turn to its maximum amount. If it does, decrease steering throw with your transmitter's EPA setting, or with the dual-rate setting if EPA is not available. Failure to do so can greatly reduce the life of your servo and influence the racing performance.

SPEED CONTROL (ESC) ADJUSTMENT

Set up the speed control according to the manufacturer's instructions. *NOTE: Some manufacturers require the motor to be connected during adjustment.*

CONNECTING THE MOTOR

Elevate the car on a stand so all four wheels can spin without touching anything. Turn on the power again. Check the speed control and steering settings once again to make sure they work properly. When finished, turn off the power and disconnect the batteries.

MOTOR GEARING

Proper gearing is critical to get maximum performance from your motor. The gear ratios listed in the chart are the recommended starting gear ratios. Ratios can vary from track to track, however the suggestions we list

Final Adjustments

is a good starting point for your tuning. Remember not to change pinions more than one tooth at a time, and that overgearing can damage your motor.

It is typically quicker to change your pinion gear than your spur gear, but this results in larger changes in gear ratios. If you want finer adjustment of gear ratio, change the spur gear.

- **More teeth on a pinion:** Higher top-end speed. However, there is typically less run time and slower acceleration. **CAUTION: Excess heat caused by overgearing (too large pinion gear) can harm your motor or electronics.**
- **Fewer teeth on a pinion:** More run time, and better initial acceleration. However, your car will attain less top-end speed.

Tailor the gearing according to track length and type (high-speed vs. technical). For larger less technical tracks, top-end speed is usually more important, so try a pinion that is a tooth larger than the chart. For smaller more technical tracks, try using a pinion that is a tooth smaller than the chart.

NOTE: Adjust gear mesh so there is only a tiny amount of play between the pinion teeth and the spur teeth.

Overall Gear Ratio Chart		pitch 1/48"			
pinion	spur g.	87	90	93	96
20					10.20
21					9.71
22				8.98	9.27
23				8.59	8.87
24				8.23	8.50
25			7.65	7.91	8.16
26			7.36	7.60	
27			7.08	7.32	
28	6.60	6.83	7.06		
29	6.38	6.59			
30	6.16	6.38			
31	5.96	6.17			
32	5.78				
33	5.60				
34	5.44				

Overall Gear Ratio Chart		pitch 1/64"			
pinion	spur g.	116	120	124	128
27					10.07
28					9.71
29				9.09	9.38
30				8.78	9.07
31				8.50	8.77
32				8.23	8.50
33			7.73	7.98	8.24
34			7.50	7.75	
35			7.29	7.53	
36			7.08	7.32	
37	6.66	6.89	7.12		
38	6.49	6.71			
39	6.32	6.54			
40	6.16	6.38			
41	6.01	6.22			
42	5.87				
43	5.73				
44	5.60				
45	5.48				



Diff pulley 34T / one way pulley 16T

Drive ratio 2.125 : 1

ROLLOUT

Rollout is a more precise way to set your car's gearing because it takes into account tire diameter, gear ratio, and transmission ratio. Rollout is defined as the distance a vehicle moves forward per revolution of the motor. The car's rollout changes as foam tire diameter changes with tire wear, tire swap, and foam tire changes, even if you do not change your gear ratio.

Rollout is affected by tire circumference. Calculate the tire circumference by doing the math:

$$\text{Circumference} = \text{Tire diameter (in mm)} \times 3.14$$

If two cars have the same gear ratio, but one has larger diameter tires, that car will have a larger rollout and higher top-end speed. Conversely, the car with smaller diameter tires will have a smaller rollout and lower top-end speed. Note that using tires of different diameters may also impact a car's handling due to differences in clearance, tire squirm, and so on.

When setting up your car at a particular track and for a particular motor, we recommend you speak with the local racers to see what a good rollout target number is. Try to match the fastest racer's rollout. Note that you cannot simply use the same pinion and spur combination, as the tire diameter and transmission ratio may be different than the other racer's car. That's when you want to consider rollout, in which the tire circumference and transmission ratio are considered in addition to the spur/pinion ratio.

To calculate rollout, measure the circumference of the rear tire, determine the number of teeth on the pinion and spur gears, and also the car's transmission ratio (the T1 family has a transmission ratio of 2.125). Then, plug those numbers into the following equations:

$$\text{Rollout} = \text{Tire circumference} \div \text{final gear ratio}$$

$$[\text{where final gear ratio} = (\text{spur} \div \text{pinion}) \times \text{transmission ratio}]$$

Here is an example of rollout of an XRAY touring car using 58mm diameter foam tires. Please note that if you run rubber tires (typically 63mm diameter), adjust the calculation accordingly:

$$\begin{aligned} \text{Transmission ratio} &= 2.125 \\ \text{Spur} &= 93T (48P) \\ \text{Pinion} &= 24T (48P) \\ \text{Tire diameter} &= 58\text{mm} \\ \text{Tire circumference} &= 58\text{mm} \times 3.14 = 182.12 \\ \text{Final gear ratio} &= (93 / 24) \times 2.125 = 8.23 \\ \text{ROLLOUT} &= 182.12 / 8.23 = 22 \end{aligned}$$

Compare your car's rollout with those of other racers' cars. Now you have the option to change your pinion or spur gears in order to get to the same rollout. You can also consider changing the tire diameter. Remember that each change you make may have other impacts on the performance of your car, so try to weigh all factors before making changes.

DIFFERENTIAL ADJUSTMENT

Differentials allow the wheels at opposite ends of the same axle to rotate at different speeds. Why is this important? When a car turns in a circle, the outer wheel has a larger diameter circle to follow than the inner wheel.

The outer wheel must travel further than the inner wheel in the course of the circle, so it needs to rotate faster to keep up. If the differential is too tight, the result is that the wheels "fight" each other for the proper rotation speed; the result is a loss of traction.



- For optimal performance, the rear diff should be as free as possible, with minimal slippage.
- When the front diff is looser than the rear diff, steering response increases.
- When the front diff is tighter than the rear diff, steering response decreases, but there is more stability in the turns.
- A tighter rear diff makes the car understeer slightly into corners, but makes the car more difficult to control out of corners (powerslides).
- Make sure that neither diff slips under power; this causes power loss and excessive wear.
- On very high traction surfaces, adjust diffs tighter for better response.

TIP: If you are not concerned about the weight of the differential (rotating weight) but long life and low wear are important for you, we strongly suggest using the XRAY Spring Steel Differential #305001, which has the longest life in the RC industry.

**Tightening the Differentials**

Tightening the differential reduces the amount of pulley slippage, but also make for a heavier (harder) diff action. Adjust the diff until you have the desired amount of slippage and diff action. An overly loose differential may loosen off when running, which may ruin the differential. The differential can be tightened when it is either in or out of the car.

Insert a small Allen wrench into the aligned holes in the setscrew and long diff shaft. Turn the long diff shaft 1/16 to 1/8 of a turn clockwise (CW) to tighten. Remove the Allen wrench and recheck the diff.

Loosening the Differentials

Loosening the differential increases the amount of pulley slippage, but also make for a easier (lighter) diff action. Adjust the diff until you have the desired amount of slippage and diff action. An overly tight diff will put more pressure on the diff balls and bearings, which may ruin the differential. The differential can be loosened when it is either in or out of the car.

Insert a small Allen wrench into the aligned holes in the setscrew and long diff shaft. Turn the long diff shaft 1/16 to 1/8 of a turn counter-clockwise (CCW) to tighten. Remove the Allen wrench and recheck the diff.

Building the Differentials

When you build the differential, do not tighten it fully initially; the differential needs to be broken in properly. Tighten the diff very gently until you feel some resistance. If you overtighten the diff initially, the diff balls will mar the surface of the diff plates, damaging the diff balls and diff plates. For exceptionally smooth operation and long diff life, use XRAY Carbide Diff Balls #305091.

If you need to assemble/disassemble the differentials, use needle-nose pliers or circlip pliers to remove the C-clip holding the axial bearing.



Final Adjustments

Checking the Differential Slippage

Slide two wrenches into the slots on both sides of the diff shafts. Hold both wrenches in one hand and try to turn the pulley; it should take some force to get the pulley to slip between the two outdrives.

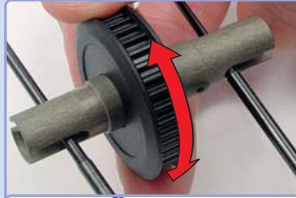

Checking the Differential Action

Remove the wrenches from the diff outdrive slots. Hold the pulley stationary in one hand, and rotate one of the diff shafts. The other output shaft should rotate, and the diff action should feel smooth.

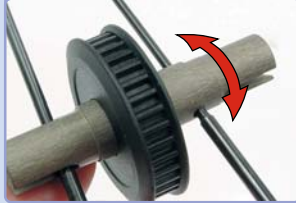

Tightening the Differential (out of car)

Insert a small Allen wrench into the aligned holes in the setscrew and long diff shaft. Turn the long diff shaft 1/16 to 1/8 of a turn clockwise (CW) to tighten. Remove the Allen wrench and recheck the diff.

Loosening the Differential (out of car)

Insert a small Allen wrench into the aligned holes in the setscrew and long diff shaft. Turn the long diff shaft 1/16 to 1/8 of a turn counter-clockwise (CCW) to loosen. Remove the Allen wrench and recheck the diff.

Breaking In the Differentials

Differentials must be broken in properly to operate properly. When breaking in the diff, the balls create a groove in the diff rings; this is normal and essential for proper operation. If you tighten the diff fully the first time you build it, the ball will not create a proper groove, and will become damaged. When you put the diff in the car and complete the assembly, run the car for a few minutes, tighten the diff a little bit, and then recheck the diff. Repeat this process several times until you have the diff tightened to the point you want it.

Final adjustments should ALWAYS be made with the diff in the car and on the track.

Adjusting the Front Differential (in car)

Place the car on the table with the front end pointing towards you. To check front diff tightness, hold the spur gear with your right hand and hold the left front wheel against the table with your right forearm, and try to rotate the front right wheel **backward** with your left hand. If the front right wheel rotates too easily, you need to tighten the front differential.

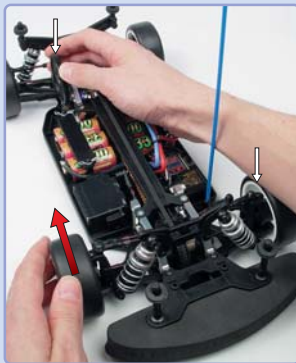

The diff output shaft on the left side of the car has a hole in it. Place a small Allen wrench into the hole, and rotate the front right wheel until the wrench

Final Adjustments

goes all the way through the diff.

- To **tighten** the front diff, rotate the front right wheel **forward (+)**.
- To **loosen** the front diff, rotate the front right wheel **backward (-)**.

Tighten or loosen the diff in 1/8 turn increments, checking the diff tightness with each adjustment.

Initial Setting:

Diff action is smooth, but tight enough so that it takes high effort to rotate the front right wheel when the front left wheel and spur gear are held tight.

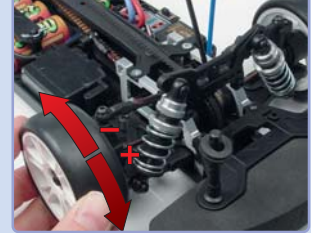
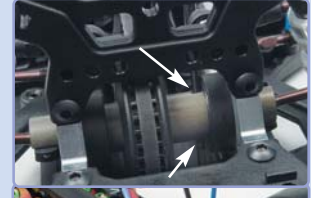

Adjusting the Rear Differential (in car)

Place the car on the table with the rear end pointing towards you. To check rear diff tightness, hold the rear right wheel and the spur gear with your right hand, and try to rotate the rear left wheel **backward** with your left hand. If the rear left wheel rotates too easily, you need to tighten the rear differential.

The diff output shaft on the right side has a hole in it. Place a small hex wrench into the hole. Rotate the rear left wheel until the wrench goes all the way through the diff.

- To **tighten** the rear diff, rotate the rear left wheel **backward (+)**.
- To **loosen** the rear diff, rotate the rear left wheel **forward (-)**.

Tighten or loosen the diff in 1/8 turn increments, checking the diff tightness with each adjustment.

Initial Setting:

Diff action is smooth, but tight enough so that it takes high effort to rotate the rear left wheel when the rear right wheel and the spur gear are held tight.

Run the car for approximately one minute, then recheck the diffs following the steps above.

Hint: The chassis is designed so that you can very easily adjust the tightness of the differentials without disassembling the car. Simply remove the body, lock up the diff by inserting a thin Allen wrench through the aligned holes, and adjust the diff.

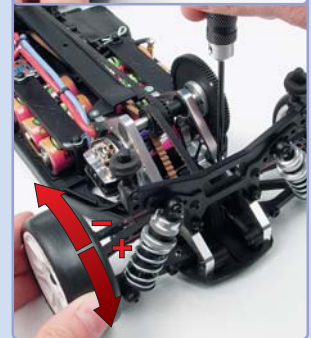

ONE-WAY PULLEY (available option)

To be able to adjust the over-steer/under-steer balance, we suggest using the #305500 Main Layshaft With Adjustable One-Way. The one-way pulley allows the front wheels to spin independently of the rear wheels. Our unique one-way system lets you determine how freely the front wheels spin. A plastic locknut on the main layshaft can be fully tightened to lock the front wheels to the rear (full-time 4WD) or loosened to let the front wheels “free-wheel” off power (4WD on throttle, RWD off throttle). Or it can be set anywhere in between to match your driving style.



Looser One-Way Pulley

The main effect of a looser one-way pulley is more off-power steering. However, this should only be done on high-traction surfaces or large tracks where minimal braking is required. Since only the rear wheels are used for braking, spins induced by a locked rear tire are more likely. One of the benefits of a looser one-way pulley is less drive train drag at maximum speed, which can increase top-end speed.

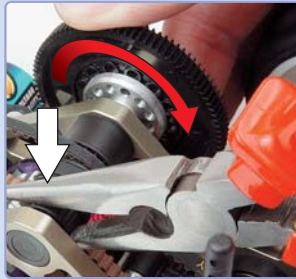

To loosen the one-way pulley, hold the locknut securely with pliers, then rotate the spur gear backward. The locknut will back away from the fixed pulley and move away from the pullies.

NOTE: Pull the fixed pulley away from the one-way pulley to let the front belt move freely without binding.

Tighter One-Way Pulley

The one-way pulley should be tightened under slippery conditions, if you need to reduce steering, or if heavy braking is needed.

To tighten the one-way pulley, hold the locknut securely with pliers, then rotate the spur gear forward. The locknut will tighten against the fixed pulley and move toward the pullies.

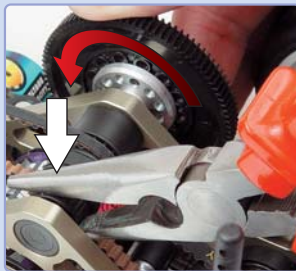

ONE-WAY FRONT DIFFERENTIAL (available option)

The optional front one-way differential (#30 5101) has independent one-way bearings for each front wheel so the two front wheels can rotate at different rates like a regular differential. On throttle, if one wheel loses traction, the other still gets power to pull the car through the turn. Under braking, the front wheels spin freely, giving better cornering ability but reducing overall braking ability.



The one-way differential should be used only on high traction surfaces where braking ability by the rear wheels alone is sufficient.

Keep in mind that when using the one-way pulley with a loose setting, or when using the one-way differential, no drag brake should be used. Most racers will also find it more convenient to set their radio to give less braking action (use the throttle EPA setting). This will prevent the rear tires from locking unexpectedly.

TRACK SURFACE	ONE-WAY PULLEY		ONE-WAY FRONT DIFFERENTIAL
	LOCKED	LOOSENED	
Low traction	✓		
Medium traction (slow, tight corners)	✓	✓	
High traction (slow, tight corners)		✓	
High traction (fast, sweeping corners)			✓

FRONT SOLID AXLE (available option)

The optional front Alu Solid Axle (#30 5180) is best suited for carpet tracks or short tracks with a lot of traffic, where maximum effective braking is required. Off-power steering is reduced.

The front solid axle should be used only at the front of the car, with a rear differential and original solid central layshaft. Using this configuration, the car achieves maximum 4WD braking, while being very stable and easy to drive.



SHOCKS

Shocks, or shock absorbers, are a part of the suspension that allow the wheels to keep as much contact with the running surface as possible. The T1R features unique 4-step externally-adjustable racing shocks that do not require you to change pistons or change shock oil to alter the damping. Damping, mounting position, spring tension, and spring preload are all characteristics that determine how the shock performs.



Springs

The shock springs support the weight of the car, and different spring tensions determine how much of the car's weight is transferred to the wheel relative to the other shocks. Spring tension also influences the speed at which a shock rebounds after compression.

Spring selection depends on the whether the track is fast or slow, or has high or low traction.

- **Stiffer springs:** Makes the car more responsive. The car reacts faster to steering inputs. Stiff springs are suited for tight, high-traction tracks that aren't too bumpy. Usually when you stiffen all of the springs, you lose a small amount of steering, and reduce chassis roll.
- **Softer springs:** Makes the car feel as if it has a little more traction in low-grip conditions. Better for bumpy and very large and open tracks. Springs that are too soft make the car feel sluggish and slow, and allow more chassis roll.
- **Stiffer front springs:** Makes the car more stable, but with less front traction and less steering. It will be harder to get the car to turn, and turning radius increases. The car will have much less steering exiting corners. On very high-grip tracks, or if the track itself feels tacky or sticky, very stiff springs are preferred.
- **Softer front springs:** Makes the car have more steering, especially in the middle and exit of a corner. Front springs that are too soft can make the car oversteer.
- **Stiffer rear springs:** Makes the car have less rear traction, but more steering in the middle and exit of a corner. This is especially apparent in long, high-speed corners.
- **Softer rear springs:** Makes the car have more rear traction in corners, through bumpy sections, and while accelerating.

XRAY Spring Tensions

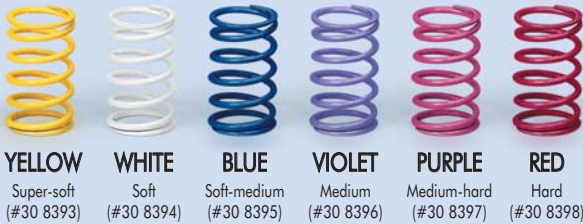

Spring Preload

Spring preload should only be used to alter ride height. Adjust the spring collar on the shocks so that the springs are only slightly compressed when the car is fully equipped, ready-to-run. To change the characteristic of the springs, change to a softer or harder spring rather than loosening or tightening the springs.

Hint: File a small notch on the top of each spring collar so you can tell when you have adjusted it one full rotation.



Shock Position

The upper and lower shock mounting positions determine how much leverage the lower suspension arm has on the shock when compressing it, and the progressiveness of the suspension. Different shock position settings change how the shock reacts to compression.

- **Shocks more inclined:** Makes the car more progressive, giving a smoother feel and more lateral grip (side-bite). When all four shocks are inclined it makes the car very easy to drive, and it feels like the car has more grip, but it is not always fastest.
- **Shocks more vertical:** Makes the car have a more direct feel, but less lateral grip.
- **Front shocks more inclined than rear shocks:** Makes the steering feel very smooth and there will be slightly more mid-corner steering. Mounting the rear shocks very upright can result in the rear feeling unpredictable and more nervous in corners.
- **Rear shocks more inclined than front shocks:** Makes the car feel aggressive turning into a corner, but most of the time the car will have slightly less steering. The car will have abundant lateral grip in the rear, so turning radius won't be very tight.

Front Shocks - Upper Mounting Position

There are three upper shock mounting positions on the front shock tower.

Initial Setting:
Front shocks: Position #2

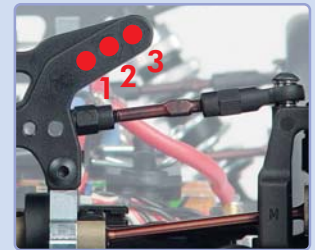

Front Shocks - Lower Mounting Position

There are two lower shock mounting positions on the front lower arms.

- **Outer position #2:** More stable, less steering. The stiffer front suspension makes the car more stable.
- **Inner position #1:** Softer damping, better steering. The softer front suspension reduces rear traction, causing the car to lose stability.

Initial Setting:
Front shocks: Outer position (#2)

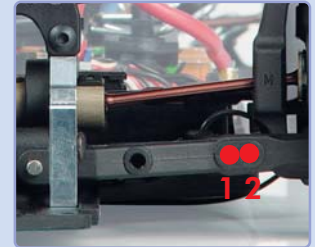

Rear Shocks -

Upper Mounting Shock

There are five upper shock mounting positions on the rear shock tower.

Initial Setting:

Rear shocks: Position #3



Rear Shocks -

Lower Mounting Shock

There are three lower shock mounting positions on the rear lower arms.

- **Outer position #3:** Harder damping, less grip, less chassis roll. Stability decreases. High-speed cornering (traction permitting) increases.
- **Middle position #2:** Optimum position for most tracks.
- **Inner position #1:** Softer damping, higher stability. Traction increases, chassis roll increases. Not good for fast corners.

Initial Setting:

Rear shocks: Middle position (#2)



Shock Oil

- **Thicker oil:** Slower shock action, slower chassis weight transfer from side-to-side or front-to-rear. In general, slower shock action means less traction, but slower weight transfer means the car is less likely to become unsettled with sharp direction changes such as in chicanes.
- **Thinner oil:** Faster shock action, faster chassis weight transfer. Faster shock action means the suspension can work faster to keep the tire in contact with the surface quicker, resulting in more traction. However, the chassis is more susceptible to chassis roll and becoming unsettled in sharp direction changes such as in chicanes.

Thicker shock oil requires the use of heavier springs to compensate for the heavy damping action. Likewise, thinner oil requires lighter springs.

We recommend using only highest-grade XRAY Silicone Shock Oil, which is available in numerous weights. This shock oil is specially formulated to be temperature resistant and low-foaming.



20W
(#30 9520)



30W
(#30 9530)



40W
(#30 9540)



50W
(#30 9550)

Shock Damping

Shock damping influences the responsiveness of the chassis during cornering, and helps to maintain proper contact between the tire and the road surface during vertical movement. No shock damping means that the spring rate determines how long it takes for the spring to compress and the suspension to reach a stable position.

Setting the right damping is always a compromise and requires a lot of "hands on" experience.

Damping only comes into play when the suspension is moving, and loses its effect when the suspension has reached a stable position. When the shock is compressing or rebounding (decompressing), the shock absorber oil resists this movement. The two factors that determine the speed at which the shock reacts are the thickness of the oil and the piston valving (the number of holes in the shock piston the oil passes through).

Damping and Shock Pistons

Shock dampening manages the resistance of the shock as the piston moves up and down through the oil in the shock body.

- **Soft damping:** Produces the most grip (both front and rear) through chassis roll, but also decreases cornering speed.
- **Hard damping:** Allows the car to break traction more easily, but with less chassis roll and higher cornering speed.

Initial Settings:

Front shocks: 2 holes open (medium-hard)

Rear shocks: 4 holes open (softest)

Initially, the damping should be set separately for the front and rear so the car quickly settles when dropped from approximately 5 cm (2"). If the car bounces before settling, the shocks are too stiff. If the bottom of the chassis hits the table, the shocks are too soft.

Shock pistons affect shock damping by affecting how easily the piston travels through the shock oil when the shock is compressed or is rebounding (decompressed). The piston has holes through which shock oil flows as the piston travels up and down inside the shock. The number of holes helps control how quickly the shock compresses or rebounds.

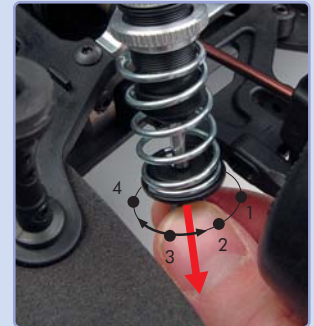

- **Less pistons open:** Harder damping, reacts like using thicker shock oil.
- **More pistons open:** Softer damping, reacts like using thinner shock oil.

XRAY shocks can be assembled with non-adjustable or adjustable pistons. The non-adjustable pistons use a 1-piece piston with 1, 2, 3 or 4 holes in it. The XRAY adjustable pistons use a unique 2-piece piston assembly that can be easily adjusted to align 1, 2, 3, or 4 holes.

- **More holes in piston:** More oil can pass through the piston as the piston moves. This means less resistance to shock movement, less damping, and faster shock movement.
- **Fewer holes in piston:** Less oil can pass through the piston as the piston moves. This means more resistance to shock movement, more damping, and slower shock movement.

We recommend you change both the shock oil weight and number of holes in the pistons for best effect.



1 hole open



2 holes open



3 holes open



4 holes open

TIRES, WHEELS, and INSERTS

Tires, wheels, and inserts are probably the most important factors in getting the best performance from your car. Getting them right is the first thing you should do. All XRAY touring cars accept all popular touring car tires, including foam tires.

Tires

When you arrive at the track with a basic car setup, select the best tires and inserts for your track, then fine-tune your setup. Check with the other racers who frequent your track for a good starting point.

Here are some general guidelines when choosing tires:

- Use treaded or radial pattern tires on dusty or unprepared surfaces, and use slicks on high-traction prepared surfaces.
- Select the rubber compound according to the track temperature. Higher temperatures usually require harder compounds.
- Try using softer tires all around for more traction.
- For more steering or front traction, try softer tires in front than those in the rear.

Regularly rotate your tires from side to side for even wear. If the same compound and inserts are used on all four corners, then rotate front to rear as well.

Inserts

Rubber touring car tires require tire inserts to retain their shape; typically these inserts are made from foam or molded foam rubber. Sponge-type inserts are much lighter, (less rotating mass means quicker acceleration), but they don't retain heat as well. So it's more likely that the tires will

overheat towards the end of a race. Molded inserts are heavier, but they retain heat better.

The density of an insert has a direct impact on the car's performance.

- **Harder (denser) inserts:** Less rolling resistance, increased cornering. Firm inserts are better for quick direction changes, since they'll scrub off less speed in high-speed chicanes. Inserts that are too hard can cause the car to be loose.
- **Softer (less dense) inserts:** More rolling resistance, more traction. Soft inserts give a little more grip, and they also make the car easier to slide; the difference between gripping and slipping (one end sliding out) isn't as harsh. Soft inserts allow you to 'throw' the car into the corner, and they probably make the car easier to drive. Inserts that are too soft may cause your car to wander and be very unstable.

Traction Compound

Traction compound (also known as tire conditioner or "traction sauce"), is a compound that is applied to tires to enhance the performance of the tires. It softens the rubber and creates more grip.

Before you apply traction compound, it is best to clean the tire surface. Use a brush to remove any residue or debris on the tires. Then, you can use motor spray or alcohol on a rag, or commercially-available name-brand tire cleaners, to clean the tires.

After you clean the tires, apply an appropriate amount of traction compound to the surface of the tire. If possible, apply at least a half-hour before you run the car. Wipe off any excess traction compound. This will help soften the tires and provide you with needed traction.

The best place to use traction compound is on a prepared surface that has limited traction. Do not use it when you are running on a dirty or dusty surface (such as a parking lot or in the street in front of your house) because the tires will become coated with a layer of dust and the car will slide around even more.

If you are going racing, be sure to ask the racers or the race directors what type of traction compound is best, or if it is even allowed.

BODY AERODYNAMICS

Aerodynamics play an important role in the performance of the car. One body may simply work better than another body. Aerodynamic effects are more apparent at higher speeds, and have less influence in slower corners.

Bodies

Typically, blunt-nosed bodies are more stable, but have less steering than bodies with a sloped nose. A body with high downforce will provide higher traction through the turns. However, high downforce usually comes at the expense of drag, so the car may not be the fastest on a long straightaway.

Wings

Another important consideration in body aerodynamics is the rear wing, which aids in rear traction. Wings are a vital part of the car's stability.

Final Adjustments

There are numerous ways to adjust a rear wing to achieve different handling characteristics and downforce. For example, you can mount a wing higher or further back on the body to create more rear downforce. Some wings even allow you to change their angle, or use different canards (side plates). Most bodies typically come with a rear wing, and some aftermarket wings are available which allow even more adjustments.

Experiment with bodies that have different frontal areas and different wing shapes to find the one that works best for you. Like most other tuning parameters, body style is also a compromise. Experiment to find out what bodies work best at your track.

Chassis Setup

TRACK-WIDTH

Front track-width affects the car's understeer and steering response. The T1R has a fixed track-width of 189mm that is optimal for all racing conditions.

DOWNSTOPS

Downstops limit how far the suspension arms travel downward, which determines how far upwards the chassis rises. The amount of downward suspension travel affects the car's handling, as it directly impacts the weight transfer of the chassis. Restricting upward chassis travel (more downstop) reduces the weight transfer of the chassis, making the car more stable. Allowing more upward chassis travel (less downstop) increases the weight transfer of the chassis, making the car more responsive but less stable; it is also better on a bumpy track. The effect may change with the type of track and/or amount of grip available. It is very important to adjust the downstops so the left and right sides are equal. Downstops are checked with the chassis elevated above a reference surface.

Hint: Use Hudy Set-up Board and Droop Gauge Tool.

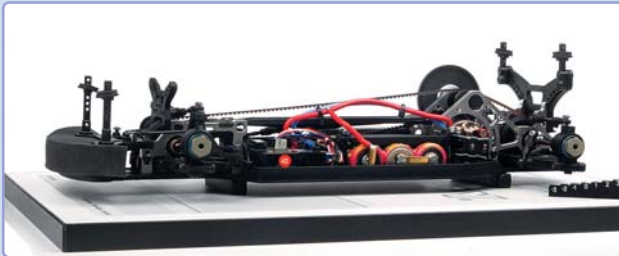

Perform these initial steps:

1. Remove the wheels from the car. Disconnect anti-roll bars if mounted.
2. Place the #10 7702 support blocks on the reference surface, then place the chassis on the elevating blocks.

Chassis Setup

Front Downstops

Using the #10 7712 measuring gauge, measure the distance from the reference surface to the bottom screws of the C-hub block (which pivots the steering blocks). Positive numbers indicate the distance (in mm) ABOVE the level of the support blocks (or, above the bottom of the chassis). Negative numbers indicate the distance (in mm) BELOW the level of the support blocks (or, below the bottom of the chassis).

Adjust the front downstop screws so the bottom screws of the C-hub block (which pivots the steering blocks) are at the recommended setting on the gauge.

Initial Setting:

3mm on gauge. (Actual measurement = 3mm above the level of support blocks).

Downstop settings depend on track condition. The above setting was for smaller tires (approx. 63 mm) and a smooth track.

Rear Downstops

Using the #10 7712 measuring gauge, measure the distance from the reference surface to the bottoms of the rear uprights. Positive numbers indicate the distance (in mm) ABOVE the level of the support blocks (or, above the bottom of the chassis). Negative numbers indicate the distance (in mm) BELOW the level of the support blocks (or, below the bottom of the chassis).

Adjust the rear downstop screws so the bottoms of the rear uprights are at the recommended setting on the gauge.

Initial Setting:

3mm on gauge. (Actual measurement = 3mm above the level of support blocks).

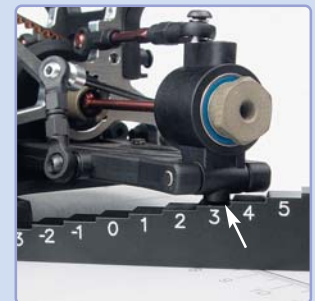
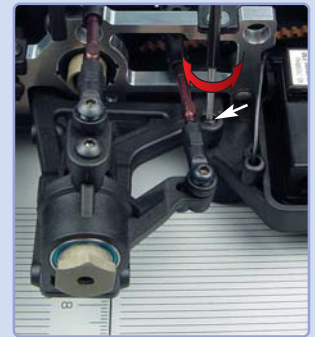
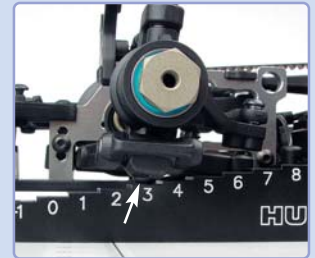

Chassis Setup

Downstop settings depend on track condition. The above setting was for smaller tires (approx. 63 mm) and a smooth track.

If you find the car has too much steering going into a corner off throttle or while braking, try adding 1mm to the rear downstop setting. This will cut down on the amount of weight that is transferred away from the rear tires when off throttle.

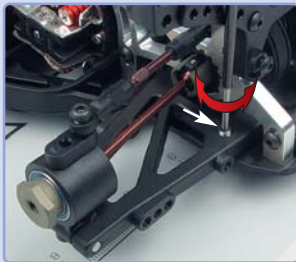

RIDE HEIGHT

Ride height is the height of the chassis in relation to the surface it is sitting on. Measure and adjust ride height with the car ready-to-run but without the body. Use the shock preload collars to raise and lower the ride height.

Perform these initial steps:



1. Prepare the car ready-to-run, without body.
2. Place the car on Hudy Set-up Board and use #10 7715 Ride Height Gauge to measure the ride height in front and rear.

Use the shock preload collars to raise or lower the ride height.

- **To raise the ride height:** Tighten the shock preload collars. Collar moves DOWN the shock body.
- **To lower the ride height:** Loosen the shock preload collars. Collar moves DOWN the shock body.

Initial Settings:

Front ride height: 4.5mm

Rear ride height: 5.0mm



Chassis Setup

Try using a slightly lower ride height for high traction conditions, such as carpet racing.



Ride Height and Tires

Ride height is measured with the wheels on the car, and the car ready-to-run. When using rubber tires, your ride height settings should stay consistent, since rubber tires do not wear down appreciably and reduce ride height. However, if using foam tires, ride height changes as the foam tires wear down to smaller diameters. Note that the tires may wear at different rates front-to-back, and left-to-right, which may eventually result in a car with uneven ride height at all four corners. When possible, true your foam tires (left and right pair at a time), and re-adjust your ride height periodically to compensate for tire wear.

Ride Height and Suspension Settings

Suspension settings are unaffected by the wheels/tires you put on the car. When you use a setup system (such as the Hudy Universal Set-Up System (#10 9300) to set your suspension settings, these settings do not change when you put different wheels on the car. With the car sitting on the ground, it may appear that certain settings are different, but this may be due to uneven tires, or tires with different diameters. However, the settings you set using a set-up system are the true suspension settings.

ACKERMANN AND STEERING THROW SYMMETRY

Ackermann is a term describing the effect of the inside front wheel turning tighter than the outside front wheel. Ackermann is used to achieve better steering through the corners.

When setting up your steering, it is very important that turning radii are the same when the car is turning either left or right. Put the car on a Hudy Set-Up System to make sure that the steering turns as sharply to the left as it does to the right. If it is not the case and if your transmitter has EPA (End Point Adjustment) settings, adjust the EPA on your transmitter in order to achieve left/right symmetry.

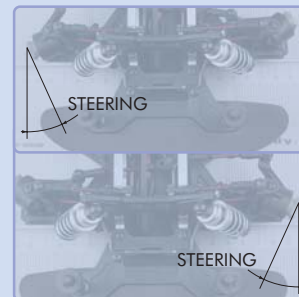

Chassis Setup

When adjusting the steering servo, adjust the steering so the steering blocks do not turn the maximum amount. If they do, decrease steering throw with your transmitter's EPA setting, or dual-rate setting if EPA is not available.

The steering system is designed with the optimal Ackermann setting for a touring car. However, you can use the optional Ackermann positions to fine-tune your car's steering.



Changing the Ackermann Setting

Move the two steering rods to the outer holes on the servo saver. Note that you must decrease the length of both the left and right steering rods by 5mm each when you change to the outer holes on the servo saver, while keeping the steering rods in the steering block outer holes.

Connecting the steering rods to the various holes on the servo saver and the steering blocks gives the following steering characteristics:



Steering block INNER holes #1, and...

- **Servo saver inner holes #1:** Equal steering of wheels. Smooth and neutral steering through the whole corner.
- **Servo saver outer holes #2:** Different steering of wheels, inner wheel closes in more. Steering into corner is smoother. Steering in mid-corner and exiting corner is more aggressive.

Steering block OUTER holes #2, and...

- **Servo saver inner holes #1:** Same as steering block INNER/servo saver INNER (above), except effect is more exponential.
- **Servo saver outer holes #2:** Same as steering block INNER/servo saver OUTER (above), except effect is more exponential.

Chassis Setup

Initial Settings:

Servo saver: INNER inner holes (position #1)

Steering block: OUTER holes (position #2)

The initial Ackermann setting gives a comfortable driving feeling. However, you can use the optional Ackermann positions on the servo saver if you want a more aggressive steering feeling. Be aware that the car may be more difficult to drive.

FRONT ANTI-DIVE

Front anti-dive refers to the angle at which the front suspension is mounted in relation to horizontal when looked at from the side of the car.

There are two possibilities for front anti-dive:

- **Upper hole (3° anti-dive):** Works well in bumpy conditions, due to the constant caster angle when the suspension is compressed. However, steering is not as responsive as the 0° anti-dive setting.
- **Lower hole (0° anti-dive):** Gives more aggressive steering when braking and especially while cornering, due to a decrease in caster when turning off-throttle.

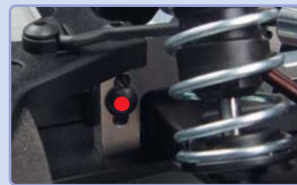
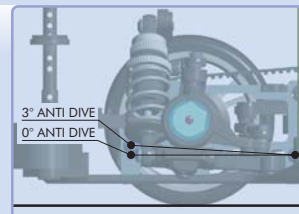

NOTE: Only use the two lower holes for front anti-dive. The front upper hole is a production hole.

Front anti-dive is very easy to adjust. Loosen the four screws that mount the front lower suspension pin holders. Then remove the two screws that hold the FRONT pair of lower suspension holders, and pivot the front of the lower arms up or down to align with the upper or lower front holes. Replace the two screws and tighten all four screws. Check for freedom of movement.

Initial Setting:

Front anti-dive: 3° (upper hole)

Note: The anti-dive setting impacts the caster setting. To get the true caster setting, add the value of caster block to the front anti-dive value. For example, if you have 3° caster block and set 3° anti-dive, the overall caster setting is 6° caster.

CAMBER

Camber is the angle of the wheels relative to the ground when looked at from the front or back.

- **Negative camber:** The tire leans inward at the top.
- **Positive camber:** The tire leans outward at the top.

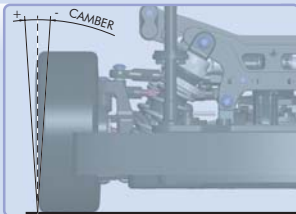

Camber affects the car's traction. In general, more negative camber means increased grip since the side-traction of the wheel increases. Do not use more than -2.5° camber, and NEVER use positive camber.

The amount of front camber required to maintain the maximum contact patch largely depends on the amount of caster. Higher degrees of caster require little or no camber, while lower degrees of caster require more negative camber.

Perform these initial steps:

1. Remove wheels.
2. Put the car on the Hudy Set-Up System.
3. Press down the suspension of the car a few times to let the suspension settle.

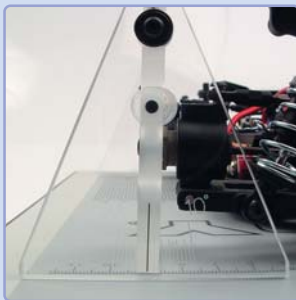

Adjusting Front Camber

Adjust front camber using the front upper camber link.

- **Shorter link:** More negative camber.
- **Longer link:** Less negative camber.

Initial Setting:

Front camber: -1.0° (tops of front wheels leaning inward)



Front Camber Link Position

The position and length of the front upper camber link affects the car's roll center, which affects front traction. In general, the steeper the angle of the camber link, the more front traction there is. The front shock tower provides three different camber link positions, some of which require lengthening or shortening of the front upper camber links to maintain an appropriate driving camber angle.

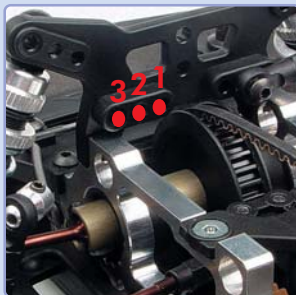

NOTE: Always use the same link positions on both sides of the car.

- **Outer position #3:** More stable, less traction.
- **Middle position #2:** Optimum position for most tracks.
- **Inner position #1:** More traction, less stability.

Initial Setting:

Front camber link: Middle position #2

Adjusting Rear Camber

Adjust rear camber using the rear upper camber link.

- **Shorter link:** More negative camber.
- **Longer link:** Less negative camber.

Initial Setting:

Rear camber: -1.5° (tops of rear wheels leaning inwards)



Rear Camber Link Position

The position and length of the rear camber link affects the car's roll center, which affects rear traction. In general, the longer the link, the more rear traction there is. The rear uprights provide two camber link positions. Switching from one position to the other requires lengthening or shortening of the rear upper camber links to maintain an appropriate driving camber angle.

- **Outer position #2:** More traction, less stability.
- **Inner position #1:** More stable, less traction.

Initial Setting:

Rear upper camber link: Inner position #1

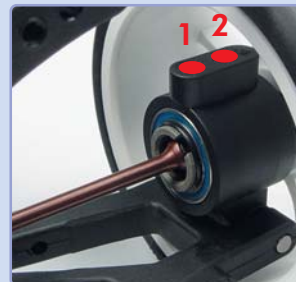

CASTER

Caster describes the angle of the C-hub block with respect to a line perpendicular to the ground. Caster angle affects on- and off-power steering, as it will tilt the chassis more or less depending on how much caster is applied.

- **Less caster** (more vertical): Increases OFF-power steering INTO a corner, but decreases straight-line stability.
- **More caster** (more laid-down): Increases ON-power steering OUT OF a corner, and increases straight-line stability, but makes the car harder to turn into a corner. It also makes the car more stable through bumpy track conditions.

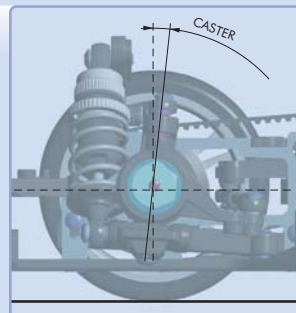

Chassis Setup

The C-hub blocks that hold the steering blocks have a specific amount of caster molded into them.

Initial Setting:

Front caster: 3°, left and right

Note: The anti-dive setting impacts the caster setting. To get the true caster setting, add the value of caster block to the front anti-dive value. For example, if you have 3° caster block and set 3° anti-dive, the overall caster setting is 6° caster.

Changing Caster

To change the caster angle, you must change the front C-hub blocks to those with a different caster angle. When changing the C-hubs, you must use left and right C-hubs that have the same caster angle.

XRAY offers several different C-hub blocks of different caster angles and different compounds:

FRONT C-HUB BLOCKS, COMPOSITE			FRONT C-HUB BLOCKS, ALU		
3° RIGHT	SOFT	# 302281	0° RIGHT+LEFT	HARD	# 302275
3° LEFT	SOFT	# 302283	3° RIGHT	HARD	# 302276
6° RIGHT	SOFT	# 302285	3° LEFT	HARD	# 302277
6° LEFT	SOFT	# 302287	6° RIGHT	HARD	# 302278
3° RIGHT	MEDIUM	# 302282	6° LEFT	HARD	# 302279
3° LEFT	MEDIUM	# 302284			
6° RIGHT	MEDIUM	# 302286			
6° LEFT	MEDIUM	# 302288			

TOE-IN & TOE-OUT

Toe-in is the angle of the wheels as looked at from directly above the car.

When the wheels are parallel the toe-in is 0°. When the front of the wheels are pointing away from each other, that is called toe-out. When the front of the wheels are pointing in towards each other, that is called toe-in.

Toe-in is used to stabilize the car, but at the cost of traction. If the car is oversteering (the rear end loses traction before the front end) extra front toe-in may reduce oversteer, but it also decreases steering. If the car is understeering (the front end loses traction before the rear end) extra front toe-out (or extra rear toe-in) may help, but this makes on-power cornering more difficult.

Front toe-in makes the car easier to drive by improving stability during acceleration, and gives a slight increase in steering exiting corners. Front toe-out increases steering when entering corners, but makes the car slightly more difficult to drive.

Perform these initial steps:

1. Remove wheels.
2. Put the car on the Hudy Set-Up System.
3. Turn the radio and receiver on, and turn the wheels left and right to let the steering set into the neutral position.
4. Press down the suspension of the car a few times to let the suspension settle.



Chassis Setup

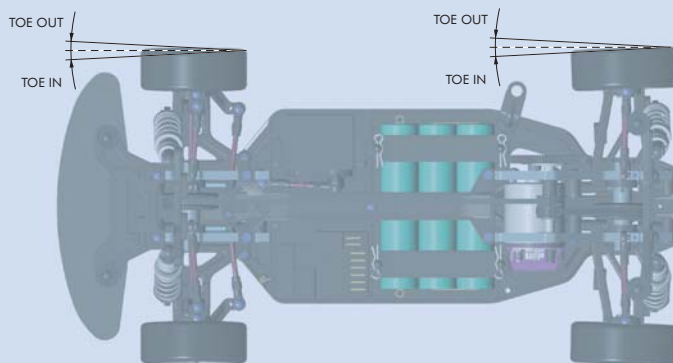

Adjusting Front Toe-In / Toe-Out

Front toe-in is adjusted with the steering rods that connect the servo saver to the steering blocks. Making the steering rods longer will create more toe-in, while making them shorter will create more toe-out. Be sure to adjust both steering rods in equal amounts to reach the desired toe angle.



Measure front toe-in using the Hudy Set-Up System.

Initial Setting:

Front toe-in: 0° (front wheels are parallel)

Adjusting Rear Toe-In

Rear toe-in is adjusted by adding or removing clips between the bulkheads and the rear lower suspension pin holders (at the BACK of the bulkheads). This angles the rear lower arms forward or backward. The initial rear toe-in setting is 3°.

To change rear toe-in, loosen the screws that hold the rear lower suspension pin holders (at the BACK of the bulkheads) to the bulkheads. Then, slide a clip onto the screw, between the holder and the bulkhead. The thicker the clip, the more rear toe-in. Tighten the screw to secure the pin holders.

Make sure you add the same thickness of clip to both left and right sides.

The following table indicates the effect of adding rear toe-in clips.

Chassis Setup



No clips = 3° rear toe-in
 1mm clip = 2° rear toe-in
 2mm clip = 1° rear toe-in

If you want to change the rear toe-in by 0.5°, use a 0.5mm shim.

Never use more than 3.0° or less than 1.0° (except maybe when using foam tires on carpet).

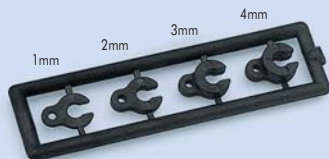

REAR ANTI-SQUAT

Rear anti-squat refers to the angle at which the rear suspension is mounted in relation to horizontal when looked at from the side of the car.

There are two possibilities for rear anti-squat:

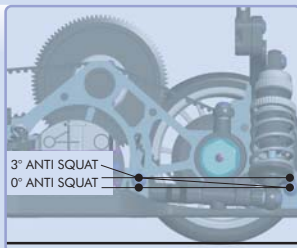

• 0° anti-squat (lower holes 2 and 1):

Improves acceleration in bumpy conditions, and gives more lateral grip (side bite) on-power and while braking. The car will be easier to drive in low-grip conditions, and the rear end will slide more easily.

• 3° anti-squat (holes 3 and 1): Provides good rear traction, makes the rear end more sensitive to throttle input. The car will have more steering while braking, and slightly more steering when powering out of corners.



Rear anti-squat is very easy to adjust. Loosen the four screws that mount the rear lower suspension pin holders to the rear bulkheads. Then remove the two screws that hold the FRONT pair of lower suspension holders, and pivot the front of the lower arms up or down to align with the upper or lower front

Chassis Setup

holes. Replace the two screws and tighten all four screws. Check for freedom of movement.

Initial Setting:

Rear anti-squat: 3° rear anti-squat (holes 3 and 1)

Rear Roll Center

You can alter the car's rear roll center by moving the rear lower suspension holders to both upper positions (upper holes 3 and 4 = 0° anti-squat).

WHEELBASE

The wheelbase can be adjusted in a 9mm range. This feature enables you to adjust the car for all conditions: asphalt or carpet, fast or technical. The wheelbase is very easy to adjust using removable adjustment clips on the rear lower pivot pins.

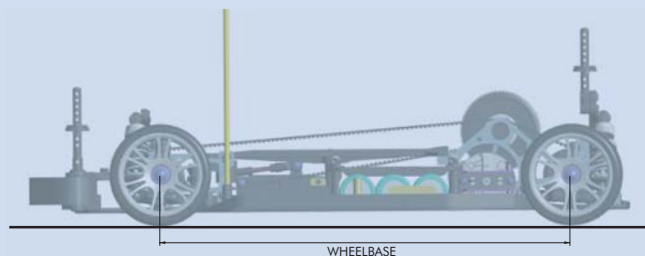

- **Shorter wheelbase:** More aggressive, better turning. Rear traction is increased by placing more weight behind the rear arms. Shorter wheelbases are better on carpet tracks.
- **Longer wheelbase:** More stable, but rear traction is reduced. Longer wheelbases are better on smooth, fast tracks especially asphalt tracks with long corners.

The initial setup of the T1R uses non-removable shims to adjust the wheelbase to 258mm, which is optimum for most track conditions.

If you want to adjust the wheelbase, remove the original shims on the rear lower pivot pins, and replace them with replaceable adjustment clips.

To remove the original shims, remove the rear lower hinge pins, remove the shims, then reinstall the rear lower hinge pins. After the rear lower arms are again in place, snap the adjustment clips onto the pivot pins. Make sure you put the proper clips in front of and behind the rear lower arm. We recommend using only the 2, 3, and 4mm clips. You can also use the 1mm clips, but keep in mind that the sum of all clips used must always total 9mm.

- **Less spacers in front of rear arm:** Shorter wheelbase.
- **More spacers in front of the rear arm:** Longer wheelbase.

Hint: Use the Hudy Caster Clip Remover (#10 7610) for easy adjustments.

Chassis Setup

Initial Setting:

Wheelbase: 6mm (2+4mm) in front of arm, 3mm behind arm

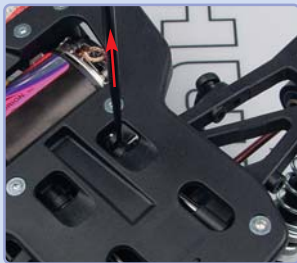

Rear Camber Link Adjustable Balls

When adjusting the wheelbase, you need to adjust the distance that the adjustable ball protrudes from the rear bulkhead.

- **Shorter wheelbase:** Extend ball further out of rear bulkhead
- **Longer wheelbase:** Push ball further into rear bulkhead.

Initial Setting:

Ball extends 10mm from rear bulkhead

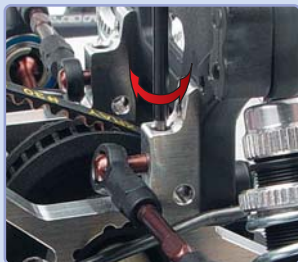

To change the length of the adjustable balls, loosen the setscrew in the top of the rear bulkhead, and slide the ball in or out according to the wheelbase setting.

Make sure that the left and right settings match. For accuracy, use the depth gauge of a caliper to measure the distance between the top of the ball and the side of the bulkhead.

Use the following table as the guideline to calculate the wheelbase setting.

Clips (mm) before arm	Clips (mm) behind arm	Wheelbase (mm)	Clips (mm) before arm	Clips (mm) behind arm	Wheelbase (mm)
0	4+3+2	252	3+2	4	257
1	4+4	253	4+2	3	258
2	4+3	254	4+3	2	259
3	4+2	255	4+4	1	260
4	3+2	256	4+3+2	0	261

Chassis Setup

ANTI-ROLL BARS (available option)

Anti-roll bars are used to stabilize the car from excessive chassis roll, which occurs when the car leans in the turns due to centrifugal force. Anti-roll bars are generally used on smooth, high-traction tracks. If the conditions are very bumpy, anti-roll bars may not be necessary.

Front Anti-Roll Bar

If you are driving on a high traction surface and the car is oversteering, use the optional front anti-roll bar kit (#30 2460). This decreases front chassis roll and steering, giving more rear traction.

Anti-roll bar adjustment is performed with disconnected shocks.

Checking Front Anti-Roll Bar Functioning

1. First, be sure you have adjusted the downstops equally on both sides.
2. Place the car on the flat board and disconnect the shocks.
3. Lift up the front right wheel very slowly. When the front left wheel starts to lift off the surface, note how far the front right wheel has been lifted.
4. Do the same thing on the other side. Lift up the front left wheel very slowly. When the front right wheel starts to lift off the surface, note how far the front left wheel has been lifted.
5. When properly adjusted, both wheels should start to move up at the same lifted position of the other wheel. If this is not the case, then the anti-roll bar needs to be adjusted.
6. Make sure the wire is not tweaked. If it is, correct it by carefully bending it straight.
7. If the wire is straight, try to decrease or increase the height of the pivot link on one of sides by adjusting the distance of the pivot balls. Adjust it little by little until both wheels move up at the same lifted distance.

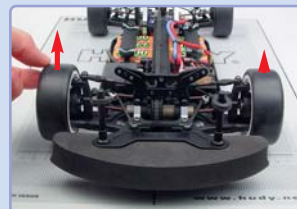
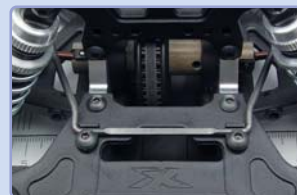

Rear Anti-Roll Bar

If you are driving on a high traction surface and the car is understeering, use the optional rear anti-roll bar (#30 3400). This decreases rear chassis roll and rear traction, giving more steering.

Checking Rear Anti-Roll Bar Functioning

1. First, be sure you have adjusted the downstops equally on both sides.
2. Place the car on the flat board and disconnect the shocks.
3. Lift up the rear right wheel very slowly. When the rear left wheel starts to lift off the surface, note how far the rear right wheel has been lifted.
4. Do the same thing on the other side. Lift up the rear left wheel very slowly. When the rear right wheel starts to lift off the surface, note how far the rear left wheel has been lifted.
5. When properly adjusted, both wheels should start to move up at the same lifted position of the other wheel. If this is not the case, then the anti-roll bar needs to be adjusted.
6. Make sure the wire is not tweaked. If it is, correct it by carefully bending it straight.
7. If the wire is straight, try to decrease or increase the height of the pivot link on one of sides by adjusting the distance of the pivot balls. Adjust it little by little until both wheels move up at the same lifted distance.

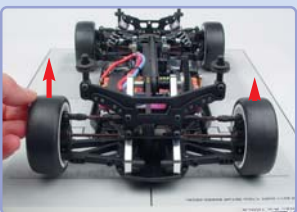

CHECKING FOR TWEAK

A "tweaked" car is an unbalanced car, and has a tendency to pull to one side under acceleration or braking. Tweak is caused by an uneven wheel-load on one particular axle. Now that the suspension geometry set-up has been completed, you must check for suspension tweak before you reconnect the anti-roll bars (optional).

Perform these initial steps:

1. Place the car on a flat reference surface.
2. Make sure that both front and rear anti-roll bars are disconnected.

Checking for Front Tweak



Lift and drop the front end of the car a few centimeters to let the suspension settle. Place a sharp tool underneath the chassis at its middle point, and lift the front end.

If one front wheel lifts before the other, the rear of the car is tweaked. Adjust



the preload on the REAR springs until both front wheels lift at the same time.

If, for example, the front right wheel lifts earlier, you must increase the preload on the rear left spring, and decrease the preload on the rear right spring.

You must adjust both rear springs, otherwise you will change the camber settings.

Reconnect the rear anti-roll bar, and check for tweak again by lifting the front end of the car. If again one front wheel lifts before the other, the rear anti-roll bar may be tweaked. Check the rear anti-roll bar with both shocks disconnected from the arms and with the chassis suspended on blocks. Make sure that the downstop adjustments are set equally. Then adjust the length of one or both rear anti-roll bar push rods until both front wheels lift

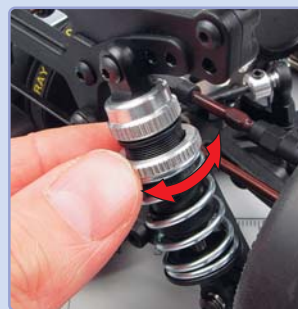

Chassis Setup

at the same time. There might happen that the wire is tweaked and therefore the suspension with connected anti-roll bars is tweaked as well. Carefully straighten the wire, and then check for tweak again. Both wheels must start lifting up at the same time.

Checking for Rear Tweak

Lift and drop the rear end of the car a few centimeters to let the suspension settle. Place a sharp tool underneath the chassis at its middle point, and lift the rear end. If one rear wheel lifts before the other, the front of the car is tweaked.

Adjust the preload on the FRONT springs until both rear wheels lift at the



same time.

If, for example, the rear right wheel lifts earlier, you must increase the preload on the front left spring, and decrease the preload on the front right spring.

You must adjust both front springs, otherwise you will change the camber settings.

Reconnect the front anti-roll bar, and check for tweak again by lifting the rear end of the car. If again one front wheel lifts before the other, the front anti-roll bar may be tweaked. Check the front anti-roll bar with both shocks disconnected from the arms and with the chassis suspended on blocks. Make sure that the downstop adjustments are set equally. Then adjust the length of one or both front anti-roll bar push rods until both rear wheels lift at the same time. There might happen that the wire is tweaked and therefore the suspension with connected anti-roll bars is tweaked as well. Carefully straighten the wire, and then check for tweak again. Both wheels must start lifting up at the same time.



Chassis Balancing



For advanced balancing, you can use Hudy's Chassis Balancing Tool (Hudy #10 7880), a simple, easy to use balancing tool. The chassis has two small holes on the underside front and rear, along the centerline.

To check the chassis left/right balance, place the two balance tools on a flat stable surface, and then place the chassis on the tips of the tools; the points fit into the chassis's centerline balancing holes. Steady the chassis with your hand, and tilt it so it is level. When you let go of the chassis, the chassis may fall to one side or the other side. If it does this, it is not balanced. If the chassis stays level without falling to one side, it is balanced.

CHASSIS WEIGHTS

Hudy offers the following additional balancing weights:

#30 9820 Additional Weights for Chassis Balancing (front - 2 pcs)

#30 9830 Additional Weights for Chassis Balancing (rear - 6 pcs)

These round weights can be used almost anywhere on the chassis.

If you need to load the front suspension, or simply add central mass to the car, you can use the following:

#30 9850 Additional Flat Weights for Chassis Balancing (center - 3 pcs)

Weight Placement

Chassis weight adjustment depends on the type of the track. If the track has more left corners, put more load on the left side. If the track has more right corners, put more weight on the right side.

The chassis has several locations at which you can secure balancing weights.

Front of Chassis

The front of the chassis does not have holes to which weights can be attached with screws. If you want to add weights to the front of the chassis, you can attach them with double-sided servo tape. You can also drill small holes in the chassis so you can attach the weights with screws.

Center of Chassis

The chassis has a central channel into which you can attach the flat center weights from the bottom with screws. When possible, we strongly recommend mounting the flat center weights using this method, as it keeps the weight central and at the lowest possible CG.



Attach the flat center weight with the tapered end towards the rear of the car.

Rear of Chassis

The rear of the chassis has holes on the left and right sides to which weights can be attached with screws. The larger, heavier round rear weights can be used, as well as the smaller, lighter round front weights.

The rear of the chassis also has left and right locations to which the transponder mount can be attached. When possible, we recommend using the transponder to balance the chassis.

FAKE TRANSPONDER

If you are preparing for a race where transponders will be used, you will benefit from practicing with weight distribution you will be actually racing with.

Hudy's Fake Transponder (Hudy #10 7890) has the same weight and dimensions as a real transponder, and using it is a great way to check the weight distribution on your car, fully equipped, ready-to-run with transponder.



Mounting the Transponder in the Front

The front upper bumper holder can be easily modified to place a transponder in the front bumper.

Using a Dremel moto-tool to remove the cross-brace molded into the upper bumper holder. Then, remove a section of the foam bumper for the transponder to sit in. Take proper precautions when using tools, and use proper eye and hand protection.

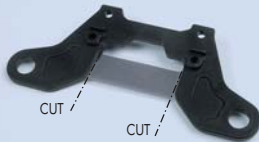

XRAY also offers an optional Precut Foam Bumper For Transponder (#30 1221) and optional Graphite Upper Holder For Precut Bumper (#30 1214).

Mounting the Transponder on the Side

The included transponder mount can be mounted on the left or right side of the chassis. When possible, we recommend using the transponder to balance the chassis instead of using balancing weights.

Maintenance is of utmost importance to achieve maximum performance, reliability, and longevity. First, maintain your car, and then work on chassis setup. Before every race, examine the following items:



DRIVE TRAIN

Check the drive shafts, wheel axles and differential pulleys for wear. Excessive wear may cause these transmission joints to lock-up and affect the suspension movement. Also check the middle layshaft and belts and all gears. Remove any debris (dirt, pebbles, carpet fibres) which may have become embedded between the teeth.

We recommend putting a little grease on the plastic blades at the end of the drive shafts and onto the drive shaft coupling.

Drive Train Binding

Disconnect the pinion gear and pull the belt. If there is binding in either the front or rear belt, one or more of the bearings may either be installed improperly or worn out. Check the bearings that support the diff outdrives (in the bulkheads) and the ones that support the axles (in the rear uprights and steering blocks).

BELTS

The belts should not be taut like a guitar string. They should be loose enough that you can wobble the belt up and down, but tight enough that the belt does not slip off a pulley under braking or acceleration.

BELT TENSIONER (available option)

The T1R chassis was designed to eliminate any fore/aft chassis flex. The Kevlar-reinforced belts resist stretching longer than most others.

There is an optional belt tensioner available (#30 3070), but it will mostly likely not be required on the T1R. The T1R has special bulkheads and eccentric ball-bearing hubs that allow you to adjust front and rear belt tension without having to use an the optional front belt tensioner.



DIFFERENTIALS

You should rebuild the differentials when they get a "gritty" feeling. Clean all parts with motor spray, then reassemble and re-adjust them. If they still feel gritty, the diff washers and steel balls should be replaced. If the gritty feeling remains, check the small 3x8 axial ball-bearing (thrust ball-bearing) and washers, and replace as necessary.

SUSPENSION

Disconnect the shocks and check the suspension for free movement. A tight arm may indicate a bent pivot pin, which should immediately be replaced. Excess play indicates that a pivot pin holder is worn. Check for the correct orientation of the plastic suspension holders. They should be in the same direction.

SHOCKS

Check the shocks for proper functioning. Check for air bubbles and make sure that the left and right sides have the same damping setting.

BALL CUPS AND SHOCK ENDS

If there is excess play (side-to-side, or lateral play; this doesn't refer to the 'looseness' of the ball cup) in these parts, you need to replace the plastic part so you get a more responsive suspension setup.

BEARINGS

Freely-rotating bearings are one of the most important factors in getting maximum performance from a car's drive train. Be especially sure that the bearings in the steering blocks and rear uprights, as well as the bearings supporting the ball diffs, are perfectly clean and rotate freely. Check all the bearings, including the one-way bearing, for wear.

If the bearings start to feel gritty, they should be cleaned and lubricated.

Cleaning Bearings

Remove the bearings from the car, and brush or wipe off any surface dirt or grime. If you have a bearing cleaner, put the bearing inside and spray with motor cleaner. If you don't have a bearing cleaner, put the bearings in a film canister, and fill 1/2 way with motor cleaner. Put the cap on the canister, and shake the canister for several few minutes.

Remove the cleaned bearing and wipe off excess cleaner. Then lubricate ball-bearings with a light oil (for ball-bearings), or one-way oil (for one-way bearings). If the bearings still feel gritty after being cleaned and lubricated, or if the bearing races develop excessive play, they may need to be replaced.

CHASSIS STIFFENING

To stiffen the chassis, we recommend using the optional #301161 Graphite Stiff Top Deck.

**MOTOR**

Between every run, carefully inspect the brushes to ensure that they move freely in the brush hood. Do this by removing the spring and sliding the brush in and out of the hood. If the action is not smooth, remove the brush and wipe it clean. This will help ensure that the brush gets proper contact with the commutator.

Also after every run, remove the brushes from the hoods and examine the brush face for wear and/or burning. If there is noticeable wear, replace them with a fresh pair. If the tip is a purple or blue color, that means they have been overheated and burnt. Burnt brushes have more resistance than fresh ones, so be sure to replace them if they are burnt.

Thoroughly clean the brushes every other run. Spray motor cleaner directly on the commutator area through the brush hoods. Spray in short bursts until the runoff is clear and clean. After cleaning, apply a small amount of lightweight oil to each bushing or bearing. Be careful not to apply too much oil, since this will pick up dirt and contaminate the commutator and brushes. We recommend you rebuild the motor after every 10 runs by cutting the commutator. If you have a motor with low winds and high-capacity batteries, we recommend cutting the commutator more often. We recommend using lathes from the RC accessory manufacturer with the highest quality - HUDY®.

RADIO EQUIPMENT

Check your radio equipment, speed control, motor and batteries for proper functioning.

SCREWS

When assembling or rebuilding your T1R, if you find that a screw has an eccentric or defective head, exchange it for the same type in the "last-aid-package". If you mount the eccentric screw on the chassis instead of exchanging or replacing it, the screw might tweak the chassis and negatively influence the car's handling.

LAST-AID PACKAGE

The kit includes a small package with some mounting hardware. We have prepared and included this special "last-aid-package" for times when you might lose some of the smaller hardware, either during assembly or when racing. We know how distracting that situation can be, especially when you want to keep focused on properly preparing your T1R for the track. This package contains a few spare pieces of each fastener and clip used on your T1R that should help you if you get caught in that situation.

REPLACEMENT MOUNTING HARDWARE

Contact your XRAY dealer for replacement mounting hardware, using the following part numbers:

- #30 9300 Hardware Mounting Package
- #30 9310 Wheels Mounting Hardware (4+4)
- #30 9320 Hex Screw Set for T1 (30)
- #30 9400 Body Clip (8)
- #30 9401 Long Clip For Transponder (2)

FRONT WHEEL AXLE DISASSEMBLY

In an extreme crash, the front wheel axle may be pressed out, which will make it hard to disassemble the wheel axle and exchange it, because the assembly will be recessed inside the steering block.

If this happens, support the block a few centimeters off the table with metal or wood blocks, and let the hex axle point down towards the table.

Use a small hammer to tap on the end of the drive shaft (you may want to first remove the plastic blade) until the axle and bearing assembly can be easily removed from the steering block.



Use a file to remove any material from the wheel axle that was pressed out along with the axle assembly.

