

# VELOCITY

## R/C EP Flying Wing



### **No.4319 Velocity EP**

\* Wing Span: 32"(813mm) \* Length: 23.5"(596mm) \* Wing Area: 263.5 sq.in. (17dm<sup>2</sup>) \* Weight: 19.8oz. (560g)  
\* Motor: 400 Included \* Prop: 5 x 5 Included \* Radio: 3 CH w/ Elevon Req'd \* Servo: 2 Micro Servos Req'd

**Warranty:** This kit is guaranteed to be free from defects in material and workmanship at the date of purchase. It does not cover any damage caused by use or modification. The warranty does not extend beyond the product itself and is limited only to the original cost of the kit. By the act of building this user-assembled kit, the user accepts all resulting liability for damage caused by the final product. If the buyer is not prepared to accept this liability, it can be returned new and unused to the place of purchase for a refund.

**Notice: Adult Supervision Required:** This is not a toy. Assembly and flying of this product requires adult supervision. Read through this book completely and become familiar with the assembly and flight of this airplane. Inspect all parts for completeness and damage. Contact Thunder Tiger authorized agent if you find any problem or need tech support.

# INTRODUCTION

All of us at Thunder Tiger want to thank you for choosing the Velocity EP. This Kit has been engineered to go together quickly and easily while still providing you with great looks and exceptional flying performance.

This electric powered flying wing is good for modeler who disires speedy flight or combat. Its airfoil, motor package and design planform are intended to maximize performance under those flying conditions and will provide great results for pilots.

We suggest that before beginning to assemble this kit you thoroughly read this assembly instruction manual to familiarize yourself with the complete assembly procedure. This will insure that your assembly process will be as smooth and uneventful as possible.

We are confident that you will enjoy flying your Velocity and that it will provide many hours of challenging and rewarding flight.

Note: This Velocity EP is suggested for intermediate to advanced pilots and not suitable for beginner.

Thunder Tiger guarantees that you should enjoy many hours of trouble free use from our R/C products. Thunder Tiger products have been sold worldwide through the authorized distributors that are supported directly and rapidly from Thunder Tiger. You may find that Thunder Tiger is always pursuing to explore new items creatively with highest quality. To update the latest product information and to get the best technical support, please feel free to contact your local hobby shops or Thunder Tiger authorized distributor.

Servo.....	3
Motor.....	4
Canopy .....	4
Vertical Fins.....	5
Balance .....	6

Open the box and check that you have all the parts as shown below.  
If anything is missing please contact your dealer

**AS6338 Foam Wing**

Foam Wing (1)

Hatch Cover (L/1, R/1)

Velcro (1)

**AS6349 Decal**

Decal (L/1, R/1)

**AS6347 Propeller**

5x5 Propeller (1)

**AS6339 Vertical Fin**

Vertical Fin (L/1, R/1)

**AS6348 Prop Hub**

Prop Drive Shaft (1) Prop Drive Nut (1)

.05" Hex Wrench (1)

4-40 x 1/8" Set Screw (1)

**AS6345 Linkage**

Pushrod (2) Clevis (2) Control Horn (2)

**AS6346 Skid & Tube**

PVC Tube (1)

Wood Skid (1)

**AS6344 Motor**

380 Motor (1)

**AS6340 PVC Deck**

Deck (1) Velcro (1)

**AS6342 Nose Cone**

Nose Cone (1)

**AS6341 SIM Carbon Canopy**

Canopy (1)

**AS6343 Motor Mount**

Plywood Part A (1) Plywood Part B (1) Plywood Part C (1) Plywood Part D (2) Fiberglass Firewall (1) Washer (2) M2.6x8 Screw (2)

## PRE-ASSEMBLY NOTES

1. If you are not an experienced R/C pilot plan to have a fully competent pilot help you to learn to fly your Velocity EP. This will help you to be successful much faster and also avoid potential damage to your model.
2. Please assemble your model exactly according to these instructions. Do not attempt to modify or change the Velocity EP in any way as doing so may adversely change its flying characteristics.
3. Before you begin please check the entire contents of this kit against the parts list and part drawings to be sure that no parts are missing or damaged. This will also help you to become familiar with each component of your Velocity EP. If you find that any of the parts are either missing or damaged please contact your dealer immediately for replacement. Note: Your dealer cannot accept kits for return if construction has begun.

## OTHER ITEMS REQUIRED

**Radio:** You will need at least a 3 channel radio control system with Elevon mix function on an aircraft frequency for use in your Velocity.

**Micro Servo:** ThunderTiger C1016 No.8117 Micro Servo is recommended for this flying wing.



**Electronic motor controller:** We recommend ACE8012 ESC-30 with BEC (work with 3CH radio) for controlling the power of your Velocity EP as well as eliminating the need for a separate radio battery. The BEC (Battery Eliminator Circuitry) in this controller will automatically turn off the power to the motor when the battery reaches a factory present discharge level leaving about 20-25 minutes of flight time for the radio system. **Note:** Some radio manufacturers offer a lightweight radio system with a built-in motor controller with BEC especially for this type of model.

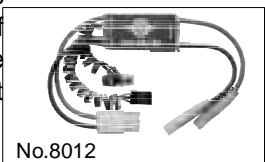

**Flight Battery:** We recommend the use of ACE 2935 8-cell 9.6V 1200 mAh NiMH battery pack for maximum performance.

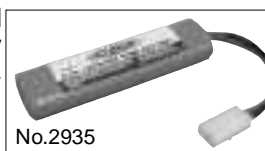

**Charger:** You will need a battery charger to charge your power battery.

## TOOLS AND SUPPLIES NEEDED

1. Thin CA Glue
2. Mixing Stick for Epoxy
3. Medium Grit Sandpaper
4. Rubbing Alcohol
5. Paper Towels
6. Hobby Knife
7. Ruler
8. Pen, Pencil or Marker
9. Small Screw Drivers
10. Curved Scissors

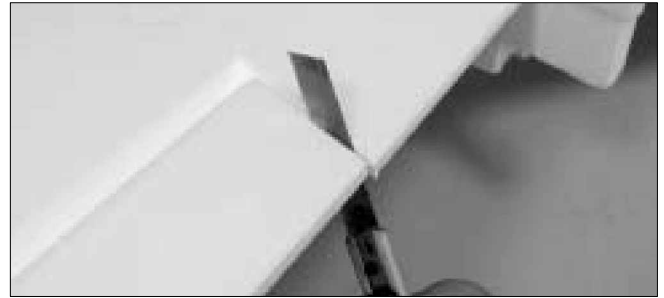

1. Cut trailing edge for aileron control surface along with the molded line with hobby knife. Note: do not cut hinge line.

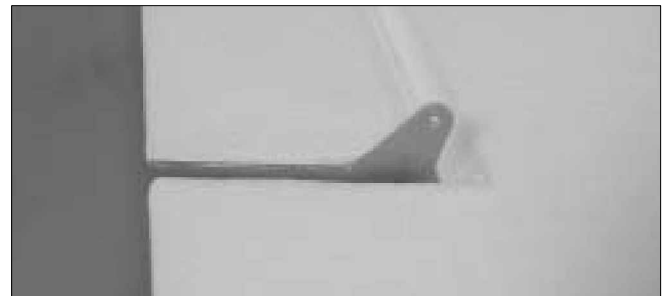

2. Locate the fiberglass control horn. Epoxy fiberglass control horn on the aileron with furnished 5min. epoxy.



3. Apply decal on the wing. Attached to the leading edge first then carefully apply decal on the wing surface to the trailing edge. Note: Do not cut away the transparent area, as it will cover the aileron area.



4. Locate the flag strip then apply it at the bottom wing surface. Note: Do not cut away the decal at the hinge line. This decal will help holding the aileron in place.

You may move the aileron at this moment and make sure it moves freely.



5. Drill holes at the grip well as shown. This is for servo wire to go through.

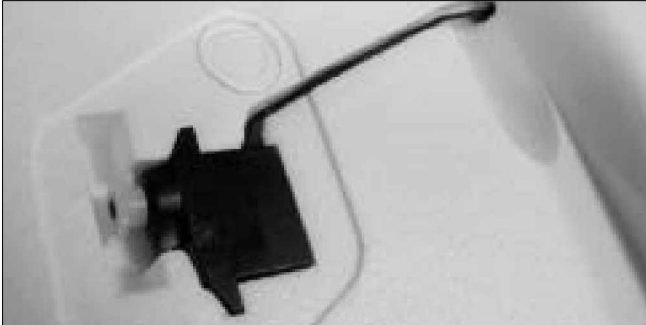

6. Trial fit the Micro Servo in the servo well. Note: the servo well is molded base on Thunder Tiger C1016 micro servo. If you are using other brand of micro servo, you may need to trim the servo well for best fit or apply double side tape for security.

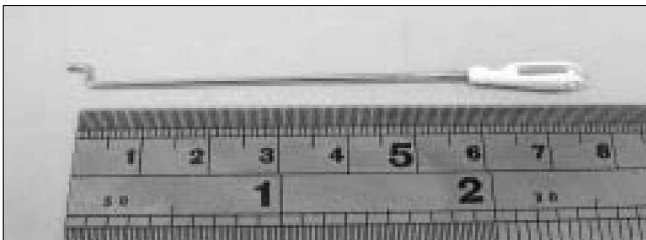

7. Locate pushrod and clevis, thread clevis and make sure the length is 2-1/2"(75mm).

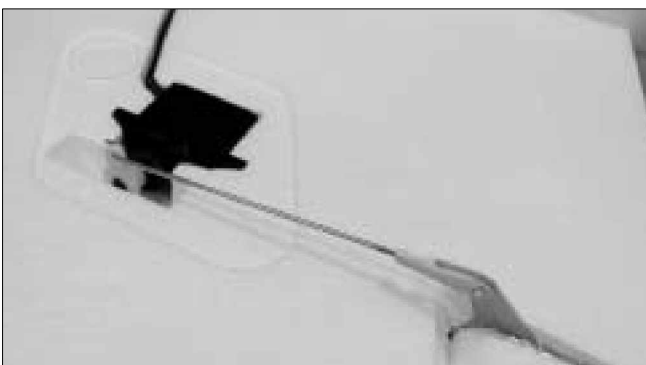

8. Install the pushrod as shown. Connect the servo wire to the receiver and set up Elevon mix function to get the neutral position. Please refer to the radio manual from manufacturer to get proper Elevon setting.

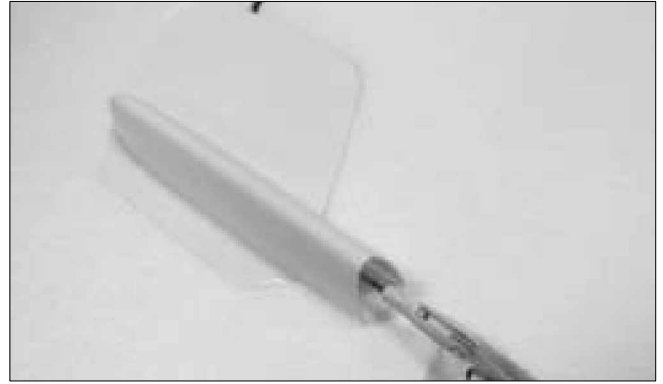

9. Adjust the clevis to make sure the aileron is level with the trailing edge of the main wing. Apply double side tape (not furnished) or epoxy to glue the hatch cover in place as shown. Repeat Step 1 to 9 on the other wing half.

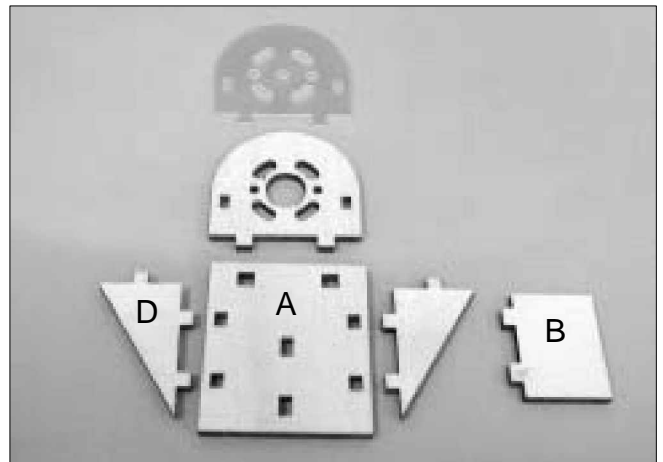

10. Locate plywood pieces and fiberglass firewall.

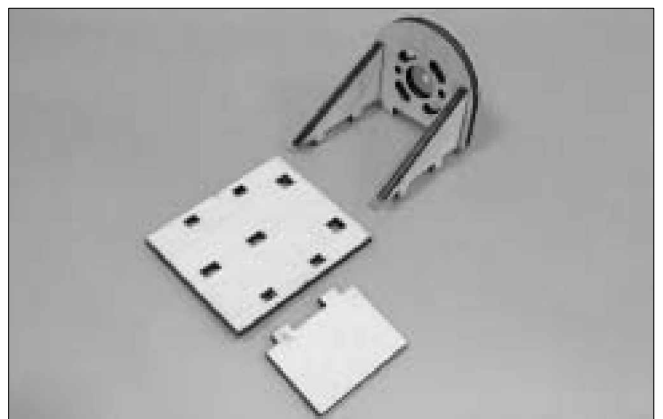

11. CA or epoxy the fiberglass and plywood firewall together then glue the plywood part D on firewall.



12. Next glue the part A and B to complete whole motor mount. Secure motor with M2.6x8 screws and washers.



13. Epoxy the motor mount assembly at the tail. Make sure the motor mount is all the way in the fuselage and secured firmly after it is cured.



14. Trim deck, canopy and nose cone along with the molded line as well as the cooling slots at the tail of deck. You need to trim the canopy tabs and deck to get a good fit when canopy is installed on the deck.

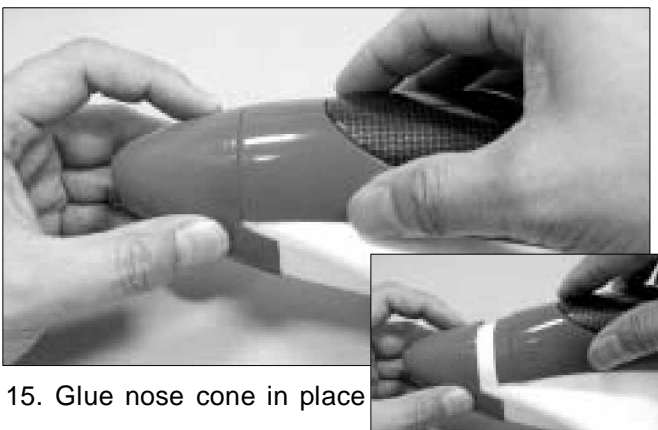

15. Glue nose cone in place

with deck installed. Make sure the deck is free and it could be removed from fuselage.

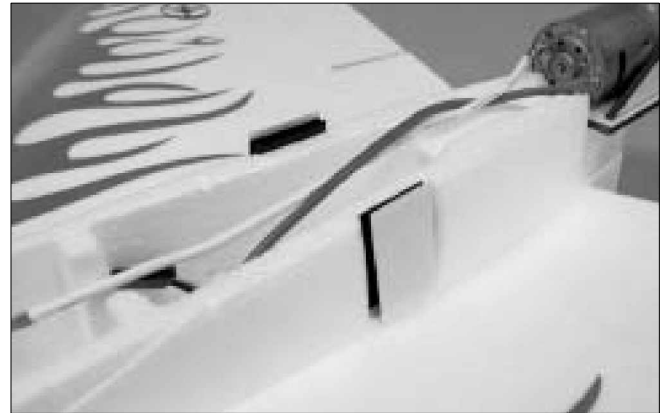

16. Locate Velcro and cut it into two pieces. Attach Velcro on the two sides of fuselage.



17. Install the deck and carefully set the deck in place then glue the Velcro.

Hint: Bend the deck and glue one side first then the other.



18. Epoxy the wood skid and antenna tube at the bottom fuselage as shown.

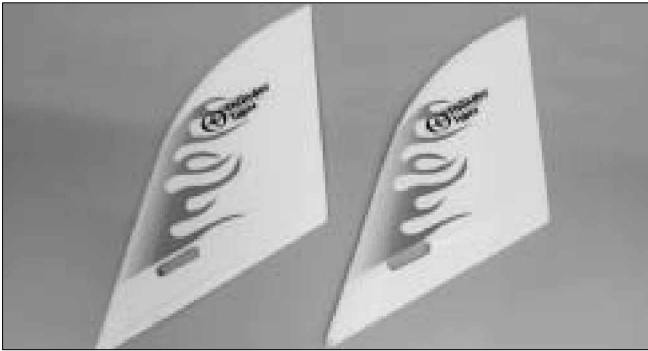

19. Locate two vertical fins. Apply decals on the fin.  
Note: Start from leading edge to apply the decal.



20. Note the orientation vertical fin. Photo shown is right fin.



21. Make marks on the vertical fin then trim away the excess portion.

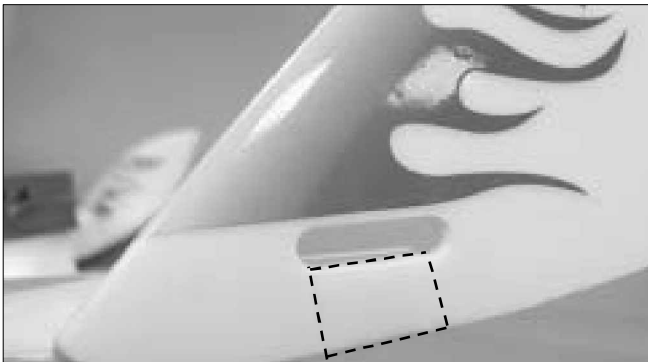

22. Epoxy the vertical fin in place as shown. To reinforce the fins in place, you may need to cut a 5/8"(1.5cm) in width and 3"(7cm) in length of a transparent strips then tape the fin at wing tips through the hole on the vertical fin.

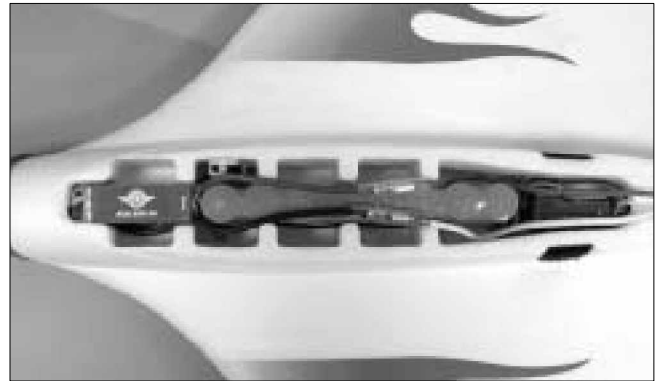

23. Connect all wires to receiver then place ESC, Battery and Receiver as shown.



24. Locate the drive shaft then secure the drive shaft on motor with the furnished setscrew and hex wrench. Next secure the propeller with the prop nut. Note: the drive shaft and prop nut are in opposite thread. Thread the prop nut counter clock-wise.



25. Route the antenna through the tube as shown.

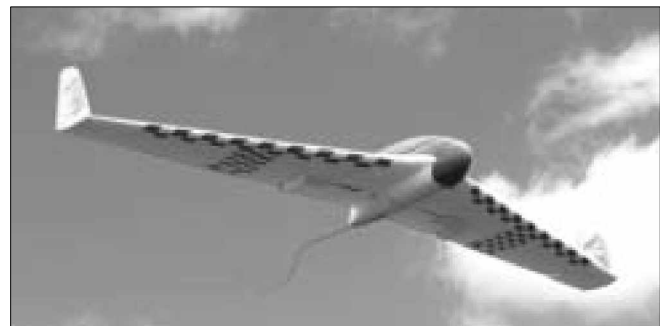

Congratulations! You are most ready to fly. Make sure fine tune the plane before you fly.

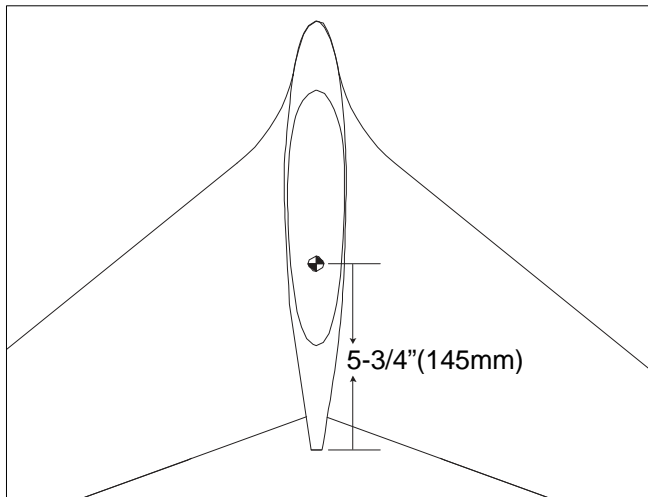

## Balance

It is important to balance the plane to get correct CG before you fly.

Balance Point: 5-3/4" (145mm) from fuselage tail.

## Other Notes When In Flight

Due to propeller is very near the bottom line, cut off the motor when landing or it will damage the motor or the structure of the tail.

## Control Throws

The following control throw of Velocity is merely a starting point for your radio setup and can be tailored to fit your flying style.

### Initial Setting of Elevon

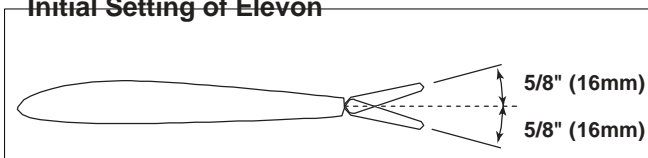

## FIRST FLIGHTS

### Checks You Should Make

Before you attempt to fly your model you should perform some final checks:

1. Fully charge your radio and flight batteries following the manufacturers instructions.
2. Check the direction of travel of your control surfaces and the operation of the motor controller per the manufacturers instructions.
3. Range check your radio system per the manufacturers instructions.
4. Double check that you have installed the screws in the servo control arms and that the clevises are snapped tightly on the control horns.

We strongly recommend that you get help from an experienced R/C pilot to learn to fly if you are just beginning. You should be able to find help at your local dealer or club field.

## Congratulations

Now that you have completed the assembly of your model we feel that have a very capable and good looking flying wing. We hope that you will enjoy this model and get many hours of flying pleasure from its use. Thank you for purchasing this Velocity EP from Thunder Tiger and we look forward to providing you with other great R/C products in the future.

