

MISC. BAG

REMOVE THESE PARTS FOR:

4015: step 1



3656, qty 4
1/8 x 5/16
unflanged ball bearing

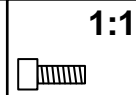

6285, qty 6
4-40 x 1/4
steel



4187, qty 2
washer



6299, qty 2
E-clip

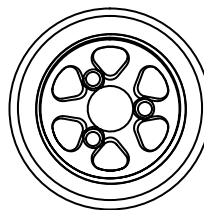

3627, qty 2
rear wheel/tire

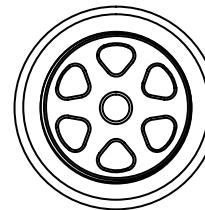

3673, qty 2
front wheel/tire

TOOLS USED

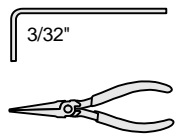

step 1

MOUNTING REAR TIRES

Install both #3627 rear tires to the hubs with three #6285 screws into each wheel hub.

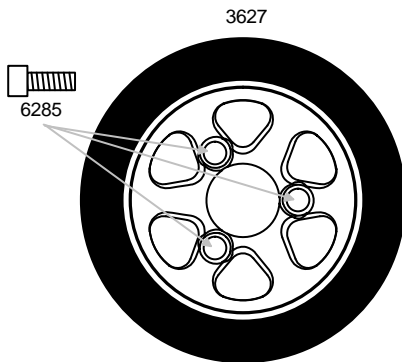

SIDE VIEW SHOWN

MOUNTING FRONT TIRES

Put a # 3656 unflanged ball bearing into each side of the front wheels. Place a #4187 washer over the axle, then slide the wheel on and secure it with a #6299 E-clip. Install the other wheel the same way.

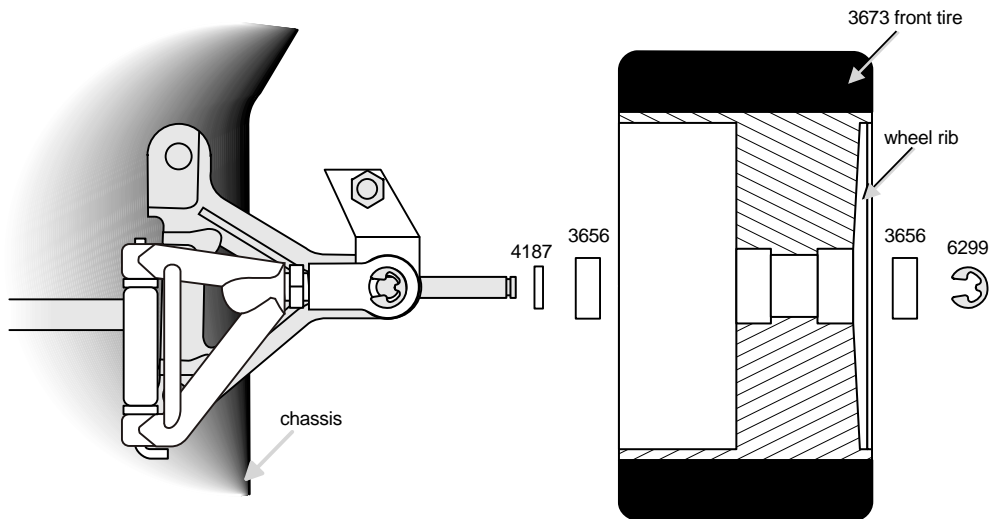

TOP VIEW SHOWN

step 2

DIFFERENTIAL ADJUSTMENT

- 1 While holding rear wheels with your hands, use your right thumb and index finger to try and rotate the spur gear. The spur gear should be very difficult to rotate. If you can rotate it easily, then tighten the #4185 11/32" nut at the end of the axle, **a little at a time**, until the spur gear is difficult to rotate.

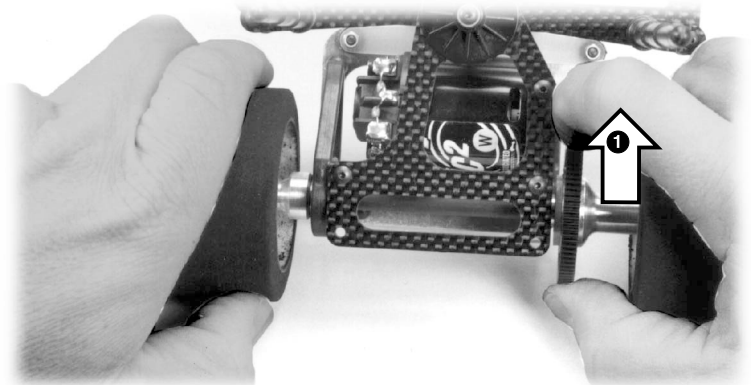

BAG E

REMOVE THESE PARTS FOR:

4015: steps 1-2

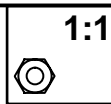

4449, qty 2
4-40 locknut

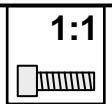

4145, qty 4
4-40 x 5/16
blue alum.

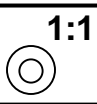

7337, qty 4
#4 washer

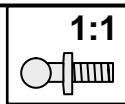

4448 qty 2
ball end

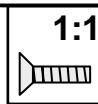

6934, qty 2
4-40 x 3/8
blue alum.

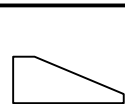

8435, qty 2
servo mounting
block



3760, qty 1
servo saver



3760, qty 1
servo saver
screw

TOOLS USED

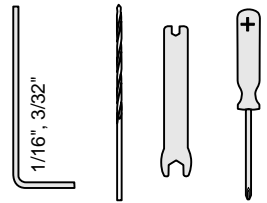

step 1

DRILLING STEERING SERVO BLOCKS

- For the 1:12 scale cars we recommend you use a small size servo. This would be a 94144 or 94145 from Airtronics; an S3002 or S3101 from Futaba, and an HS-235AG or HS-225BB from HiTec.
- Drill two holes with a #43 (or 3/32") drill into the #8435 servo blocks where shown for your servo size.

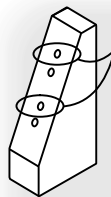

1 for large servos,
drill these two

Airtronics 94102,
94737
Futaba S148, 9101

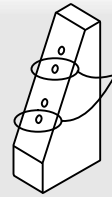

1 for small servos
(recommended)
drill these two

Airtronics 94144, 94145.
Futaba S3002, S3101.
HiTec HS-235AG, HS-235BB.

2 drill into block
perpendicular to
the slanted face

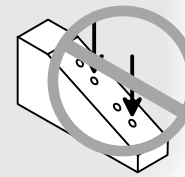
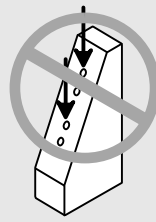
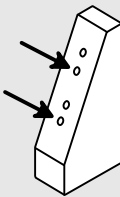

NO! Don't drill
into the block at
an angle to the
slanted face

step 2

MOUNTING THE SERVO

- Secure the servo to the #8435 blocks with four #4145 screws and four #7337 #4 washers.

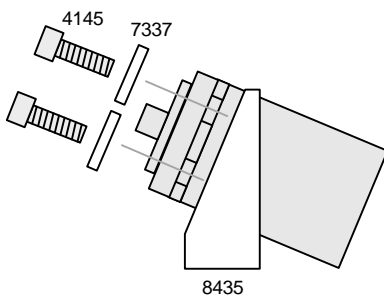

DRILL SERVO SAVER

- Use your #34 or 3/32" drill bit to carefully drill the two mounting holes for the #4448 ball ends.

ASSEMBLING THE SERVO SAVER

- Thread two #4448 ball ends into the front side of the #3760 servo saver. Secure the ball ends with the #4449 locknuts.

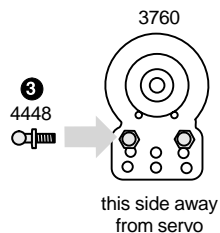

FRONT

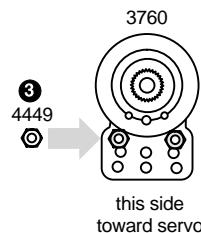

REAR

MOUNTING THE SERVO ASSEMBLY

- Mount the servo saver to the servo with the #3760 screw. **Note:** If you have a metal gear servo, use the stock mounting screw.
- Mount the servo mounting blocks to the chassis with two #6934 screws.

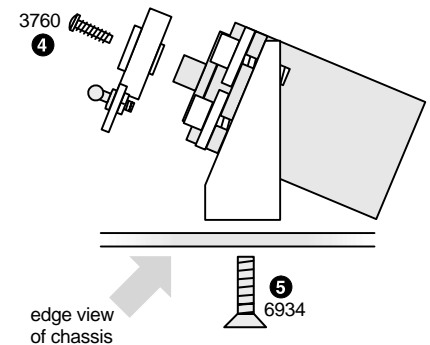

BAG E

REMOVE THESE PARTS FOR:

4015: steps 3-4

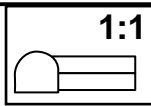

6274, qty 4
ball cup

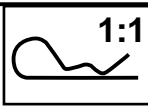

6332, qty 6
body clip

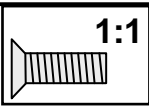

6280, qty 2
8-32 x 1/2

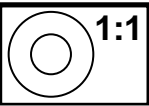

3323, qty 2
#8 alum.washer

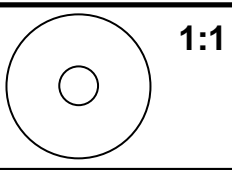

7320, qty 2
large body washer

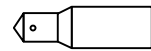

3320, qty 2
front body mount

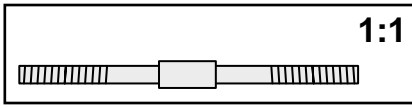

1404, qty 2
blue titanium turnbuckle

TOOLS USED

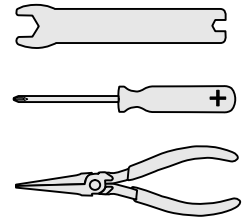

step 3

STEERING LINKAGE

- 1 Install the plastic ball cups onto the #1404 steering turnbuckles. Match the length of the turnbuckles to the actual size picture.
- 2 Snap one ball cup onto the ball end on the servo saver. Snap the opposite end on as shown. Install both turnbuckles.
- 3 When you are adjusting your turnbuckles, always make sure that the servo saver is pointing straight down.

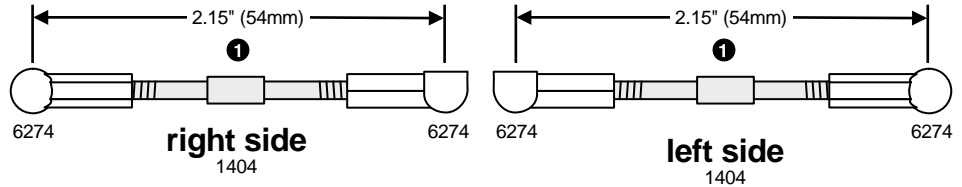
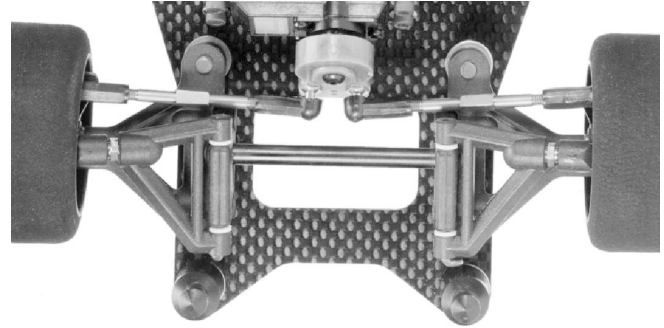

step 4

FRONT BODY MOUNTS

- 1 Tighten the #3320 front body posts to the chassis with two #6280 screws from underneath. Depending on what body you choose to use, you may need to add the #3323 aluminum washers between the body posts and the chassis. Add #6332 body clips to the front posts to hold the body in place.

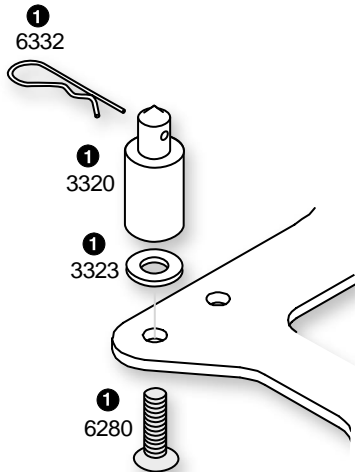

REAR BODY MOUNTS

- 1 You will have to add the #6332 body clips and #7320 washers according to the body type you purchase separately.
- 2 Add one body clip to each rear post to set the height of the body, then place one washer on top of the body clips. Place the body on top.
- 3 After adding the body, place the other body clip on the post to hold the body in place.

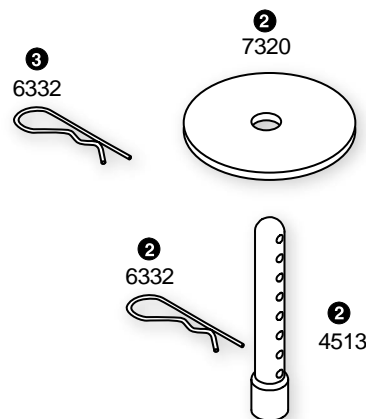

BAG E

REMOVE THESE PARTS FOR:

4015: steps 5-6

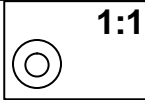

7337, qty 2
washer

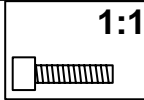

6515, qty 2
3mm x 10mm
gold



6726, qty 1
servo tape strip

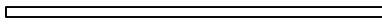

4510, qty 1
roll over antenna



4510, qty 1
antenna cap

TOOLS USED

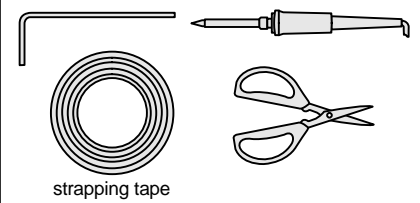

strapping tape

step 5

PINION GEAR INSTALLATION

- Slide the pinion gear onto the shaft so that the gear is 1/16" away from the motor can. Tooth side of gear should be farthest from can. Tighten the set screw to hold it in place.

MOTOR INSTALLATION

- Insert the motor into the rear pod assembly as shown, the pinion gear coming through the right side motor bulkhead.
- Tighten the motor to the bulkhead with two #6515 screws and two #7337 gold washers. Set the gear mesh so that there is very little play between the spur and pinion gear. **Note:** If the gear mesh is too tight, you can lose significant power.

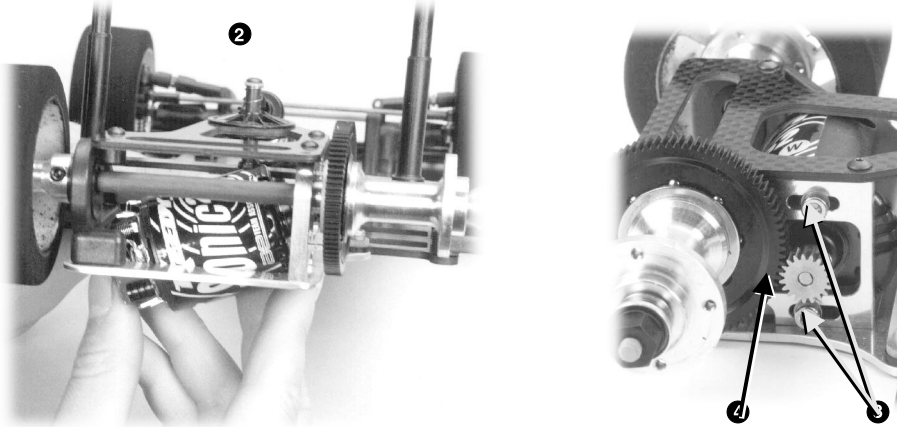

MOTOR AND PINION GEAR ARE NOT INCLUDED IN KIT

step 6

ELECTRICAL INSTALLATION

- Solder your single cell batteries together with battery braid or battery bars. Solder plus (+) to minus (-).
- Hold the batteries to the chassis with strapping tape. Wrap the tape over the batteries, through the chassis slot, underneath the chassis, and up again through another slot, several times.
- Cut the #6726 servo tape to fit the bottom of the speed control and receiver. Peel the backing from the servo tape and place them where shown in the drawing.
- Insert the #4510 roll over antenna into the antenna mount, wrap the antenna wire up the antenna, and secure the wire with the antenna cap.
- Now connect the electronic speed control and steering servo to your receiver **according to your radio or ESC instructions**, then connect the motor and batteries to the ESC.

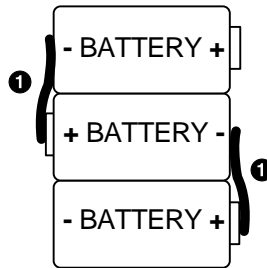

= RED WIRE
 = BLUE WIRE
 = BLACK WIRE

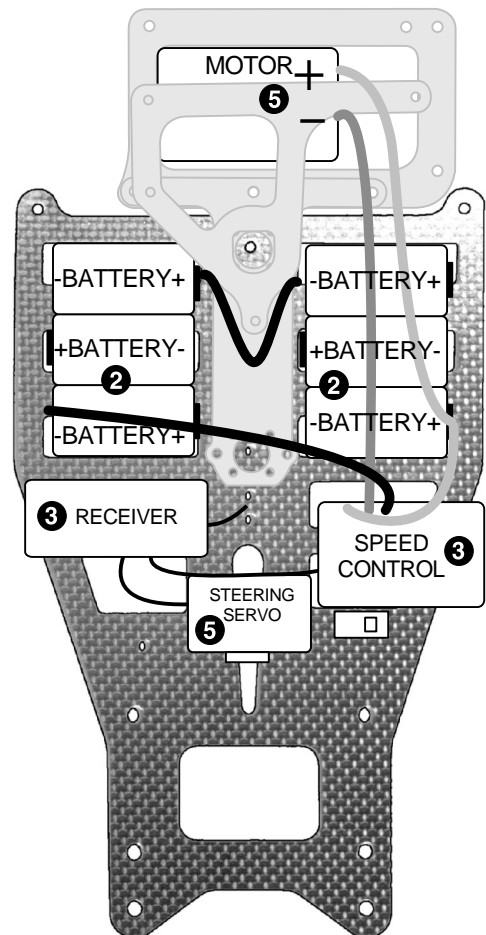

ELECTRICAL ITEMS ARE NOT INCLUDED IN KIT

SETTING THE TWEAK

We set the "tweak" after EVERYTHING except the body is installed on the car, including batteries, motor, speed control, and all the radio equipment.

WHAT IS TWEAK? Ideally, the left wheel should be pushing down on the ground with exactly the same force as the right wheel. If this is not happening, the car is TWEAKED (or twisted). This can cause the car to spin out easily under acceleration. It will also cause the car to oversteer in one direction and understeer in the opposite direction.

CHECKING THE TWEAK.

1 Measure the front chassis width. Use half of this

measurement to find the centerline of the chassis.
2 Scratch a mark at the centerline at the front of the chassis with your hobby knife.

3 To tweak the car, place the tip of a hobby knife on the center mark as shown.

4 Lift the front of the car slowly. We want both front tires to leave the ground at the same time. If one tire leaves the ground before the other one, the car is tweaked.

CORRECTING THE TWEAK. Loosen the T-bar tweak screw 1/8 turn on the tire side that left the ground last. Now tighten the opposite tweak screw (the one that left the ground first) 1/8 turn. Now recheck the tweak. Continue to make these adjustments until both tires leave the ground at the

EXACT SAMETIME. Always loosen one screw first, then tighten the opposite screw the same amount.

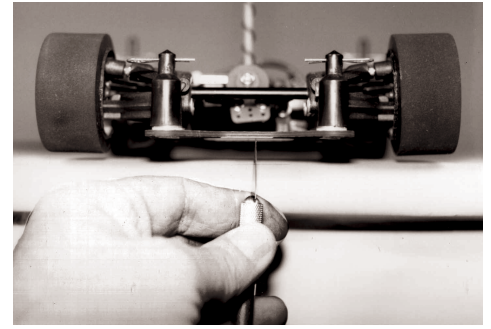

RADIO ADJUSTMENTS

Charge the transmitter batteries if they are NiCads. (See your radio manual for instructions.) Next charge your battery pack according to the instructions included with your battery charger or battery pack. Make sure all the ESC (electronic speed control) connections are according to the appropriate manuals. Now use the following steps to make the final adjustments on your car.

1 Turn the transmitter switch ON.

2 Make sure the motor is unplugged or unsoldered.

3 Plug in or solder in your battery pack.

4 Turn the car switch to the ON position. (This is normally attached to the ESC.)

5 Move the steering control on the transmitter to the right. Do the wheels steer to the right? If not, you must reverse the steering servo direction on

your transmitter (see radio manual).

6 After you have the wheels steering in the correct direction, remove your hand from the steering control on the transmitter. Now look at the servo horn mounted on the servo. Is it pointing straight down? If not, adjust its position with the steering trim control on the transmitter, or move its position on the servo.

7 Now look at your front wheels. Are they pointed straight ahead in relation to the center line of the chassis? If not, first check the alignment of the servo saver in relation to the wheels. Do they now point straight ahead? If not, use the steering tie-rod turnbuckles to adjust each wheel so that it is pointed straight ahead.

8 Adjust the ESC according to the speed control manufacturer's instructions. **Note:** Some manufac-

urers have the motor connected during adjustment and some do not. Now turn the car ON/OFF switch OFF.

9 Place your car on a block or car stand so that the rear wheels cannot touch anything. Turn the car switch back ON. Check the ESC operation and settings. After you have set and checked the speed control, turn the car switch OFF.

10 The transmitter switch must always be the **FIRST SWITCH TURNED ON** and **THE LAST SWITCH TURNED OFF**.

CONGRATULATIONS! YOUR CAR IS NOW READY TO RUN!

PAINTING THE BODY

1 While the body is still clear, mark and cut out the holes for the body mounts and antenna tube.

2 Clean the body and wing thoroughly with warm water and a mild dish soap before painting.

3 Mask the inside of the body according to your paint scheme, using automotive masking tape for the best results. Take the time to press down all edges of the tape. Cover the body holes with tape on the outside.

4 Spray the body and wing, applying the paint in thin coats and letting it dry between coats. We recommend Pactra paints.

MOTOR GEARING

To get the most from your motor proper gearing is important. The gear ratios listed in the chart below are recommended starting gear ratios. Ratios can vary from track to track but you should not change the pinion size more than one tooth from the recommended ratio.

CAUTION! Increasing the pinion size by more than one tooth can damage your motor from excess heat.

MOTOR	PINION	SPUR
24° ROAR stock motor	26	75
DS Spec motor	25	75
36° stock motor	24	75
14 turn modified motor	21	75
13 turn modified motor	20	75
12 turn modified motor	19	75
11 turn motor	18	75

BATTERY CHARGING & DISCHARGING

The battery packs used for R/C cars are six-cell, sub-C, rechargeable type found in any hobby shop.

CHARGING. Proper battery charging and discharging is important to maintain the performance and life of your battery pack.

Associated recommends the use of a good quality automatic peak detection type charger. Peak detection chargers will automatically sense when the battery pack is fully charged and shut off, thus lessening the chance of damage due to over charging. Timer chargers are not recommended because a mistake can be made, thus damaging the battery pack.

DISCHARGING. To maintain performance from your battery packs, it is recommended you completely discharge them between charges. There are several inexpensive dischargers available at your hobby shop. Associated recommends the light bulb type discharger that is popular with the racers. Follow the discharging instructions supplied with your discharger for best battery performance.

MAINTENANCE

FOLLOW THESE STEPS TO KEEP YOUR CAR IN SHAPE FOR RACING

You should periodically check all the moving parts: front and rear end, suspension arms, steering blocks, steering linkage, shocks, and so on. If any of these should get dirty or bind, then your car's performance will suffer.

MOTOR MAINTENANCE

Between runs, inspect the brushes to ensure they are moving freely in the brush holder. This is done by carefully removing the spring and sliding the brush in and out of the holder. If there is any resistance or rough spots, remove the brush and care-

fully wipe the brush clean. This will clean off any buildup and lubricate the brush so it slides smoothly in the brush holder.

After every 3 to 5 runs, remove the brushes from the holders and inspect the tips for wear and/or burning. If there is a noticeable amount of wear, replace the brush with a new pair. If the tip is a burnt blue color, then the lubricant in the brush has been burned away and new brushes should be installed.

After every other battery charge you should carefully clean the motor. One recommended

method is to spray motor cleaner directly on the brush and commutator area. Run the motor for approximately 15 seconds. Disconnect the motor and spray it again, making sure the runoff is clear and clean. If the runoff is still dirty, repeat the spraying action until clean. After completing the cleaning, apply a small amount of lightweight oil to each bushing or bearing for lubrication. Be careful not to apply too much oil, for this will pick up dirt and contaminate the commutator and brushes.

RADIO MAINTENANCE

A radio problem is not always caused by the radio system. Often it is the result of a combination of several factors which can include: motor noise, poor electrical connections, poor wiring layout, reversed or defective receiver crystals, weak transmitter batteries, and so on. If your radio problems persist, one of the following tips may help:

1 Make sure the motor brushes are free in their

brush holders.

2 Try a different motor.

3 Try a different radio frequency.

4 Try mounting the receiver on its side with the crystal up to get it away from the chassis. Also try adding more servo tape to the bottom.

5 Try moving the receiver to a different location.

6 Bundle the radio wires well away from the servo and battery wires. Either can generate a signal into

the antenna wire.

7 The new high frequency speed controls can generate a signal which can cause interference with the receiver. Try to keep them an inch apart if possible.

Keep in mind that you can also run into outside interference. 75 MHz radio band will tend to be more susceptible to this problem than the 27 MHz band.

DIFFERENTIAL MAINTENANCE

You should rebuild the differential when the action gets somewhat "gritty" feeling. Usually cleaning the diff and applying new lube per the instructions will bring it back to new condition. Normally, as the parts seat, the diff will get smoother. If, after carefully cleaning and relubing the diff parts, the diff still feels gritty, the 1/8" balls and drive rings should be checked and possibly replaced. Refer to the diff section to correctly assemble the diff.

CLEANING YOUR CAR

You can clean your car and electronics (radio and speed control) with an electronics parts cleaner that is designated safe for plastics. They are convenient and work very well, but can be expensive. If you remove your electronics you can also clean the car and motor with motor cleaning sprays. Like the electronics cleaners, this works very well, but can cost a lot. To keep your maintenance costs down, you can clean the car (not

the motor or electronics) with normal household cleaners like 409, Fantastic, Simple Green or Associated's #711 Reedy Car Wash. These cleaners have more water in them, so to prevent rust on the metal parts you must completely dry all of these parts, or else spray them with WD40. **WARNING!** Most of these cleaners have chemicals in them that will affect the Lexan body. (Reedy Car Wash is Lexan safe.) The best way to clean your Lexan body is with warm water and a mild dish soap.

TUNING & SETUP TIPS

THESE STEPS PREPARE YOUR CAR FOR MAXIMUM PERFORMANCE

Your car is one of the most tunable on road cars on the market. This section will try to explain the parts and adjustments you can use to tune your car for different track conditions.

CASTER CHANGE

The 0° mount is level with the chassis when mounted. The 10° mount is angled 10° in relation to the chassis or lower suspension arm. This angle provides a change in caster during suspension movement. The caster angle will change 2° during full suspension travel. **Your car will steer more aggressively when using this option.** The start-

ing or static caster setting is changed using the PTFE caster shims. Static caster starts at either 2°, 4°, or 6°. A more detailed example would be a starting caster of 2° will have 0° caster at full suspension travel and a starting caster of 6° will be only 4° at full suspension travel.

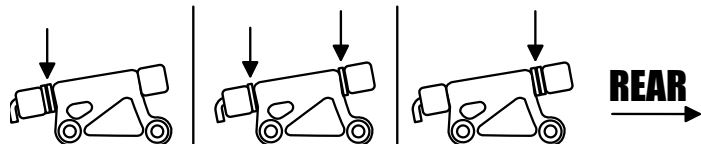

10° mount,
2°- 0° caster
2 shims forward

10° mount,
4°- 2° caster
1 shim each side

10° mount,
6°- 4° caster
2 shims to rear

CAMBER is a word describing the angle at which the tire and wheel rides relative to the ground when looked at from the front or back. This is one of the most important adjustments on the car. Negative camber means that the tire leans inward at the top, putting it closer to the centerline of the car than the bottom of the tire. Positive camber means just the opposite, the top of the tire is further away from the centerline of the car than the bottom of the tire.

Excessive negative camber will decrease traction but increase stability. Positive camber will do the same. We suggest a starting setting of 2° of negative camber. Try to use at least 1° to 2° negative camber at all times and make adjustments to keep your tires wearing flat. This can be adjusted by turning the upper arm turnbuckles in the appropriate direction.

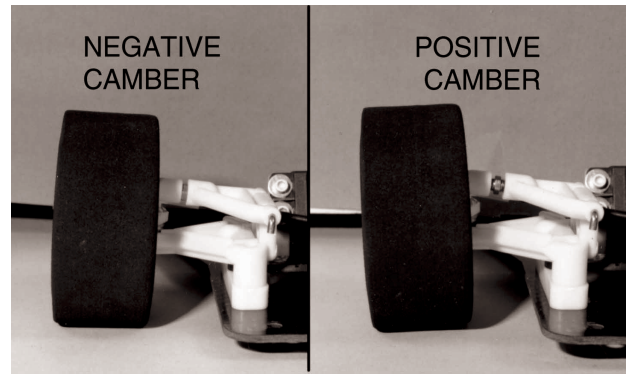

TOE-IN AND TOE-OUT is a beneficial adjustment and has a fairly significant effect on the car. Toe-in will help stabilize your car and it also removes a small amount of turn in steering. Toe-out will allow the car to turn in to a corner quicker but will reduce stability exiting the corner. Both toe-in and toe-out will scrub speed so try to use as little, of either, as possible. You adjust the toe-in or toe-out by adjusting the length of the steering tie-rod turnbuckles.

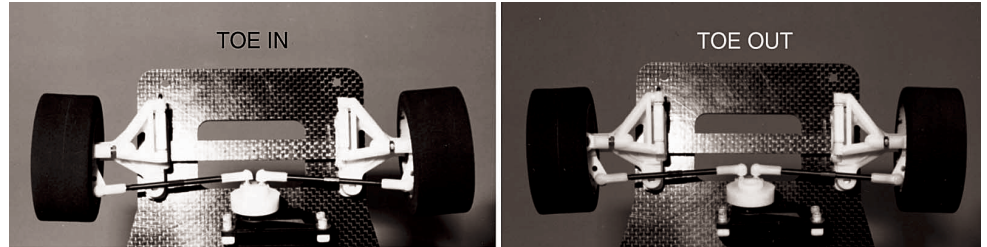

FRONT SUSPENSION SPRINGS

are available in various wire sizes as listed here. Changing springs will increase or decrease steering. In general, a softer spring (smaller wire diameter) will add steering and a harder spring (larger wire diameter) will decrease steering. Oval racing will normally require a harder spring than road course racing. The #4015 12L3 kit includes #4414 springs.

Part Number	Wire Size
#4116	(.024")
#4117	(.022")
#4113	(.020")
#4114 (kit spring)	(.018")
#4119	(.016")
#4118	(.014")

Harder (less steering)



Softer (more steering)

DAMPENER PLATE MAINTENANCE

It is very important to keep the dampener plates CLEAN and lubed for each race. We recommend using the Associated #6636 diff lube that came with your kit, or Associated #1105 Green Slime lube.

DAMPENER PLATE ROLL STOP INSERTS #4518, are included with your kit. There are two different size roll stops. Each stop will control the amount of roll that the chassis can make during hard cornering. The stop with the smallest side to side opening (in the middle) will reduce the chassis roll the most. This stop insert will make the car change directions VERY quickly during cornering. The second roll stop insert with a slightly larger opening will have slightly less of this effect. No roll stop insert (which is what we recommend for a starting setting) will be the least

aggressive for steering during hard cornering. **WARNING! You must pay very close attention to tire diameter when using either of the roll stop inserts. This is because any difference in tire diameter (side to side) may cause the dampener post to rest against the roll stop insert.** We do not recommend these inserts for oval racing.

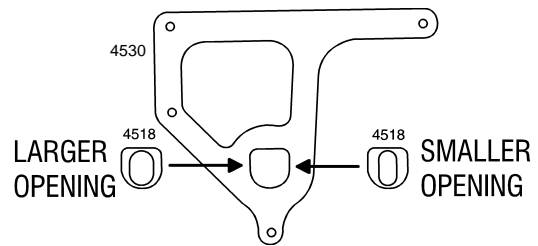

T-BAR THICKNESS AND FLEX

Your RC12L3 comes with the #4522 T-bar, with a thickness of .063". An optional #4520 T-bar has a thickness of .075". The .063" T-bar is the recommended thickness for low traction conditions. The .075" T-bar is recommended for high-traction conditions. If you use the .075" T-bar, your car will turn more aggressively, but will not be as smooth accelerating through bumps. The .063" T-bar will give the car more rear traction and will seem smoother through the bumps. We recommend using the .075" T-bar when racing on smooth carpet tracks with good traction.

Look at the back end of the of the T-bar at the "T" shaped section. You will see there are three holes which can be used to attach the T-bar to the lower rear pod plate. You have assembled your car using only the two outermost holes. This setup will make the rear suspension very active (soft) front-to-rear with very little effect on the side to side stiffness. Your car will have more rear traction and will accelerate through bumps better than if you were using all three attachment holes. Try using all three attachment holes when racing on smooth, high traction conditions.

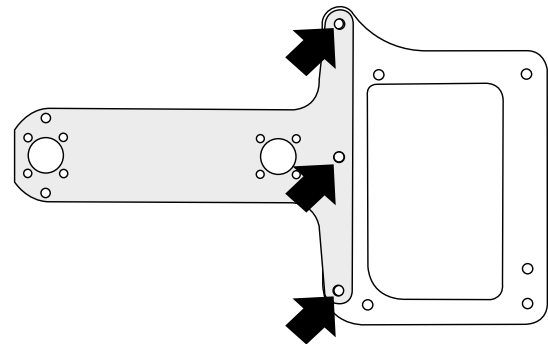

REAR AXLE HEIGHT ADJUSTERS

Your car comes with four sets of rear axle height adjuster inserts. These inserts allow you to raise or lower the height of the back of the car without changing tire diameters. Even though there are only four offsets, three can be rotated 180° for a total of seven different axle heights as shown.

#4-UP #1-UP #2-UP #3 #2-DOWN #1-DOWN #4-DOWN

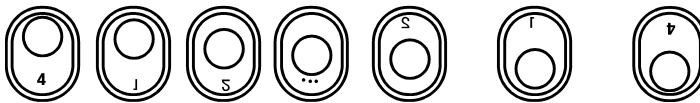

The #4-up position allows you to use the maximum diameter tire and the #4-down position requires you to use the minimum tire diameter. This adjustment allows you to get more useful life from a set of tires by adjusting axle height as tire diameter decreases. You can also adjust the overall height of your car for high or low traction conditions.

FRONT RIDE HEIGHT

To obtain your desired ride height, you can place a thick #3323 aluminum spacer under the lower suspension arm. To raise the car, take away spacers, and to lower the car, add spacers.

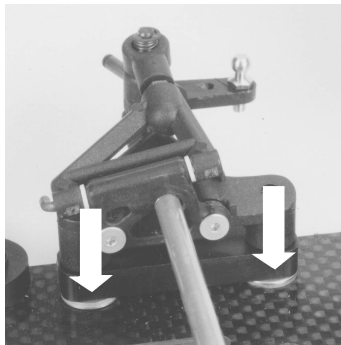

INCREASING STEERING

To increase steering, replace the stock #8421 steering blocks with the optional #8441 inline steering blocks and #8443 axles. This will make the car steer very aggressive. **Note:** The inline axles use #6902 bearings.

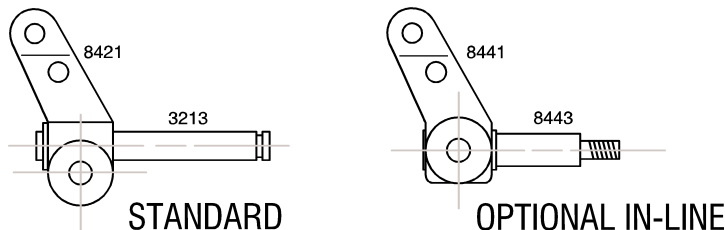

SETUP SHEET

The next page shows Team Associated's setup sheet for your car. Copy this form and keep a record of the settings you used for a particular track. This record of your settings will make it easier to set up your car the next time you race at that track, as well as compare differences between tuning adjustments. This is a feature that our Team drivers take full advantage of.

SAVE THIS BOOKLET!

More than an instruction manual, its also a handy pictorial supplement to Team Associated's RC12L3 catalog.

Refer to this manual for part numbers and description when ordering parts or to explain problems for customer service calls.



3585 Cadillac Ave.
Costa Mesa, CA 92626
(714) 850-9342
fax (714) 850-1744
<http://www.rc10.com>



TEAM ASSOCIATED ONLINE!

<http://www.teamassociated.com>

Get online help, tips, and new products for your kit through Team Associated's web site!

Tech Help, where answers to racers' questions are posted for all to learn from.

Racer Spotlight, where other racers proudly show off their favorite kit.

Setup Sheets, where racers go to find blank and standard setups to download for their kit.

New Products, where you learn of new kits and parts before they are announced anywhere else!

Team Associated Insiders Newsletter. Sign up for it on the Home Page if you want news delivered right to your e-mail box!

Question of the Week. Join in and give your opinion of the topic of the week, and learn from other racers.

Hobby Shop and Track listings. Shops that carry Associated parts and where you can race your kit.

R/C Kits and Parts. Online catalogs updated with new parts as soon as they come out.

Feedback Form. Tell us what's on your mind with this exhaustive survey.



Help Form. Our expert staff answers your toughest questions about Associated, Reedy, and LRP products.

Free Stuff. Get your Associated kit computer wallpaper and screensavers here!

RC12L3

SETUP SHEET

DATE: _____
 DRIVER: _____
 TRACK NAME: _____
 EVENT: _____

TIRES/WHEELS	FRONT	REAR
TIRE TYPE		
TIRE DIAMETER		
STAGGER		
WHEEL TYPE		
TRACK WIDTH (car)		
TIRE TREATMENT TYPE		
SHADE IN AMOUNT OF TIRE TREATMENT:		
	FRONT	REAR
	outside →  ← inside	inside →  ← outside

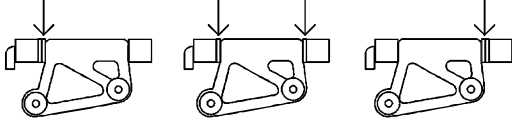
FRONT END	FRONT CASTER circle one:
FRONT SUSP. SPACERS QTY	
FRONT SPRINGS (thickness)	
UPPER ARM MOUNTS: <input type="checkbox"/> 0° <input type="checkbox"/> 10°	
FRONT CAMBER	

REAR END	
SHOCK OIL	SHOCK SPRING
SPRING COLLAR PRELOAD	
T-BAR THICKNESS	T-BAR SPACERS, QTY
DAMPENER SPRINGS	DAMPENER SPRING SPACERS QTY
DAMPENER ROLL STOP INSERT:	<input type="checkbox"/> none <input type="checkbox"/> larger dia <input type="checkbox"/> smaller dia
DAMPENER LUBE:	<input type="checkbox"/> yes <input type="checkbox"/> no
DAMPENER LUBE TYPE	
REAR RIDE HEIGHT ADJ.:	<input type="checkbox"/> #4-up <input type="checkbox"/> #1-up <input type="checkbox"/> #2-up <input type="checkbox"/> #3 <input type="checkbox"/> #2-down <input type="checkbox"/> #1-down <input type="checkbox"/> #4-down

BODY & ELECTRONICS		
BODY TYPE AND MAKE	SPOILER/WING <input type="checkbox"/> yes <input type="checkbox"/> no	POSITION:
BATTERY TYPE	NUMBER OF CELLS	
MOTOR TYPE & WIND		
GEAR RATIO	SPUR SIZE	PINION SIZE
SPEED CONTROL	CURRENT LIMITER	
RECEIVER TYPE		

TRACK DESCRIPTION:

RACE COMMENTS:

CAR COMMENTS:



FACTORY Team

RC12L3



- Factory Blue Aluminum Right Bulkhead #4537B
- Magnesium Right Bulkhead #4538
- Carbon fiber composite left bulkhead #4541
- Titanium Front Axles #1599
- Factory Blue VCS Micro Shock Body and Shaft End #4471B
- VCS Micro Shock Springs:
 - Black, 4.0, Soft #4475
 - Green, 6.0, Hard #4476 (kit standard)
- Factory Blue Chassis Brace Standoffs #4442B
- Factory Blue Aluminum Screw set #4178
- Factory Blue Titanium Turnbuckles #1250
- Factory Blue Ball Studs (8) #4447
- Factory Blue Left Hub, #4552B
- Factory Blue Right Hub, #4553B

TEAM ASSOCIATED

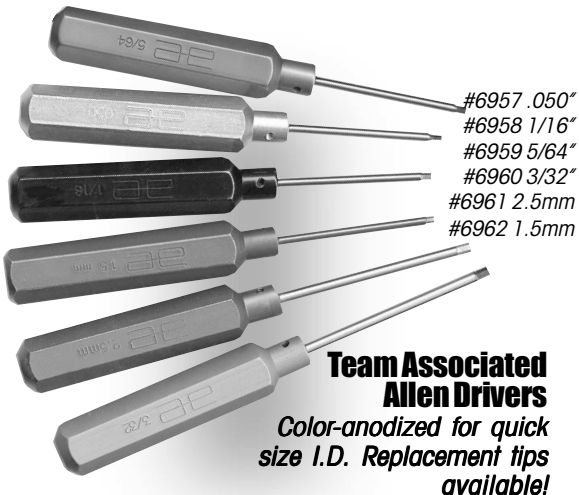

**Team Associated
Allen Drivers**
Color-anodized for quick
size I.D. Replacement tips
available!

- #6957 .050"
- #6958 1/16"
- #6959 5/64"
- #6960 3/32"
- #6961 2.5mm
- #6962 1.5mm



**Associated
"Stealth" Pinions**
Precision-machined
and surface hardened
for superior durability!

- | | |
|-----------|-----------|
| #8252 15T | #8256 19T |
| #8253 16T | #8257 20T |
| #8254 17T | #8258 21T |
| #8255 18T | #8259 22T |
| | #8260 23T |
| | #8261 24T |
| | #8262 25T |
| | #8263 26T |
- 48
Pitch**

ORDERING INFO:

Credit card orders welcome. Include your credit card number, expiration date, and name as it appears on the card. (VISA, MC, AmEx, Discover)

Ordering by mail or fax:

1. Write out your order on a separate sheet of paper. Include part number, quantity, and price of each item. Include your phone number, full name, and mailing address. DO NOT SEND CASH.

2. California residents ONLY add 7.75% sales tax.

3. Add shipping fee of \$4.50 to all orders. Faster Red, Orange, or Blue Label UPS Shipping and international orders require extra charges.

4. C.O.D. fee is \$5.00. (C.O.D.= Collect on Delivery)

5. International orders not placed by credit card must be prepaid by International Money Order in U.S. funds.

6. Mail to: Associated Electrics, Inc., 3585 Cadillac Ave., Costa Mesa, CA 92626 USA.

