

# Find your zone

Everything in Zone 1 is designed to have you flying or driving the first time you take the controls, even if you've never experienced radio control before. But that's just the beginning. Once you get your feet wet with Zone 1, you can try any one of our Zone 2 or Zone 3 machines and experience a whole new level of RC excitement.

Z1



**Skill Zone 1 Air**  
No experience necessary – "out of the box" success your very first time.

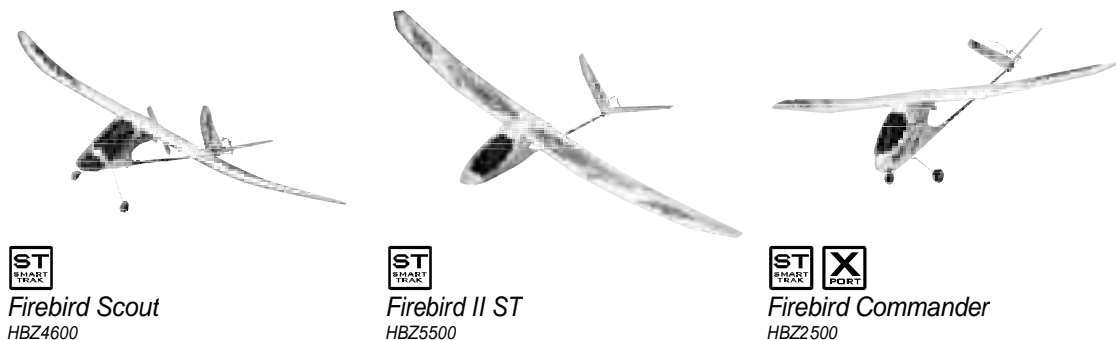

**ST**  
**Firebird Scout**  
HBZ4600

**ST**  
**Firebird II ST**  
HBZ5500

**ST** **X**  
**Firebird Commander**  
HBZ2500

Z1



**Skill Zone 1 Surface**  
No experience necessary – "out of the box" success your very first time.



**Zig Zag Racer 2**  
HBZ3400 (Yellow) HBZ3405 (Red) HBZ3410 (Blue)

**Mini Mauler Monster Truck**  
HBZ3000 (Black) HBZ3005 (Red) HBZ3010 (Blue)

**M1A1 Abrams Tank**  
HBZ2050 (Tan, 27MHz) HBZ2051 (Green, 49MHz)

Z2



**Skill Zone 2**  
Skill Zone 1, previous RC experience or experienced guidance is recommended for success.

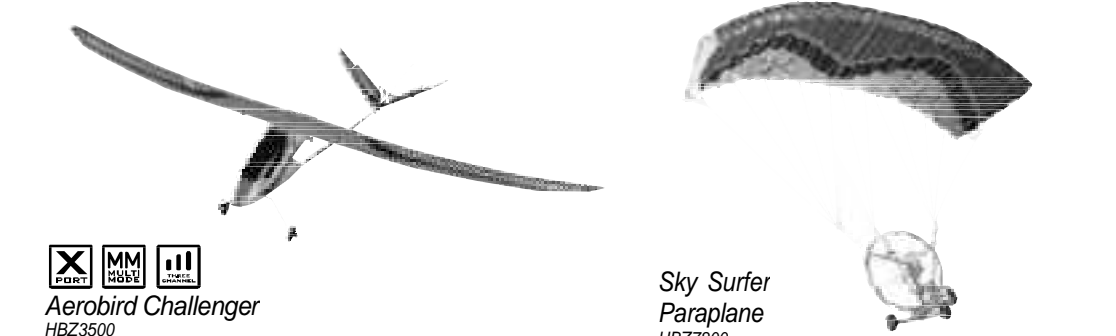

**X** **MM** **3**  
**Aerobird Challenger**  
HBZ3500

**Sky Surfer Paraplane**  
HBZ7800

Z3



**Skill Zone 3**  
Advance your abilities. Skill Zone 1 or 2, and/or previous RC experience required. Instructor assistance recommended.

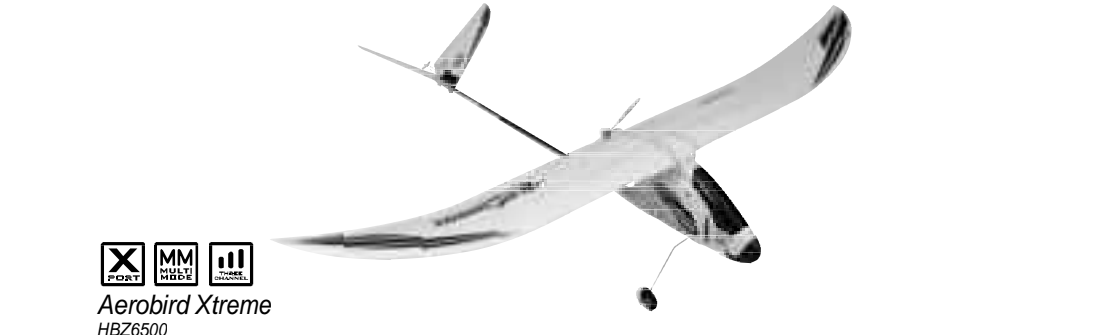

**X** **MM** **3**  
**Aerobird Xtreme**  
HBZ6500

**ST**  
**SMART-TRAK: BEGINNER SUCCESS ASSURED**  
A FEATURE ON MANY ZONE 1 AIRPLANES AND USES TIME-BASED CALCULATIONS TO PRECISELY ADJUST CONTROL SURFACE TRAVEL SO YOU CAN ENJOY EXCELLENT CONTROL RESPONSIVENESS AT ALL THROTTLE SETTINGS.

**MM**  
**MULTI MODE: MORE THAN ONE WAY TO FLY**  
MULTI MODE FLIGHT CONTROL GIVES YOU TWO WAYS TO FLY: SPORT MODE OR PRO MODE. SPORT MODE LETS YOU GET THE FEEL FOR A PLANE BY KEEPING CONTROL RESPONSES SMOOTH AND MANAGEABLE. ONCE YOU'RE COMFORTABLE, YOU CAN UNLOCK PRO MODE FOR EXTREME AEROBATIC MANEUVERABILITY.

**X**  
**PORT: EXPANDING YOUR EXPERIENCE**  
A REVOLUTIONARY NEW TECHNOLOGY THAT LETS YOU TRANSFORM YOUR PLANE INTO A FIERCE FIGHTING MACHINE OR AIRBORNE DROP SHIP WITH EXCITING ACCESSORIES. ADDING AN X-PORT ACCESSORY IS AS SIMPLE AS CLIPPING IT ON AND PLUGGING IT IN.

**3**  
**THREE CHANNEL: THROTTLE, STEERING, PITCH**  
IF YOU'RE AN ADVANCED HOBBYZONE PILOT OR SOMEONE WHO ALREADY HAS RC FLYING EXPERIENCE, 3-CHANNEL PLANES LIKE THE AEROBIRD CHALLENGER™ LET YOU CONTROL PITCH, IN ADDITION TO THROTTLE AND STEERING.



6913

# Mini MAULER™

## 1/20 Scale High-Performance RC Monster Truck

Congratulations on your purchase of the HobbyZone Mini Mauler. In order to have the most success and avoid unnecessary damage, please read this instruction manual thoroughly before driving it for the first time. While the Mini Mauler does come completely ready-to-run with nothing left to buy, and is ideal for RC beginners, it is still a sophisticated radio controlled model that must be operated with caution.

Operating your Mini Mauler recklessly could result in damage to your truck and other property. HobbyZone and Horizon Hobby shall not be liable for any loss or damages, whether direct, indirect, special, consequential, arising from the use, misuse, or abuse of this product or any other to operate it. If at any time you have any questions about your Mini Mauler, please call toll-free at 1-877-504-0233 (Monday-Friday 8 a.m. to 7 p.m. CST) and our Product Support technicians will gladly assist you.

**Z1**

**Completely Ready-To-Run**  
Includes Truck, Transmitter and Batteries

**hobbyzone**  
radio control sports  
hobbyzonesports.com

### Mini Mauler Safety Tips

Your Mini Mauler™ is controlled by radio signals, and can be subject to temporary interference outside of your control. To avoid damage from interference always drive your Mini Mauler in an area that is spacious enough to avoid collisions.

### When Operating Your Mini Mauler:

- Stay in open areas away from cars, traffic and people.
- Never run out into the street after your Mini Mauler for any reason.
- Always have a responsible adult supervising.
- Never run your Mini Mauler with low transmitter batteries.
- Always follow the directions included with optional support equipment such as chargers, rechargeable battery packs, etc.

### Tools and Equipment You May Want to Use for Routine Maintenance:

- Soft bristle brush for cleaning
- 5.5 mm nut driver for wheel nuts (DYN2803)
- #0 Phillips screwdriver (DYN2827)
- Flat head screwdriver (DYN2830)

### Equipment Included with the HobbyZone Mini Mauler RTR Monster Truck:



8 "AA" Heavy-duty batteries for transmitter











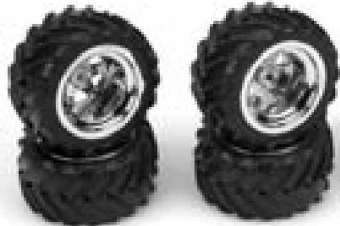

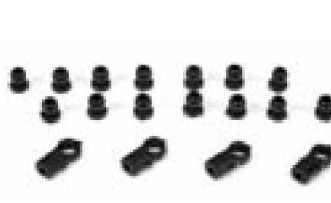



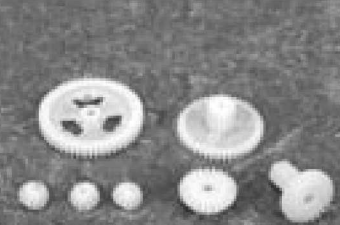
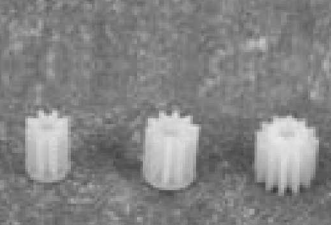

4 "AA" Alkaline batteries (shown installed into included dry cell battery holder.)

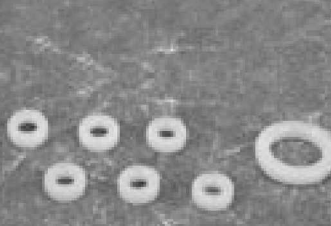

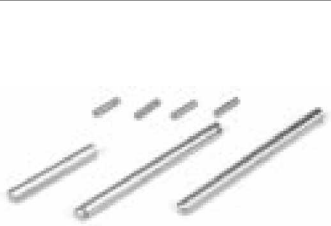
DYN2830 DYN2827 DYN2803

### Required Equipment:

There is no additional equipment needed to run your Mini Mauler, however, there are additional upgrade parts and accessories you can purchase to increase performance. You'll find a complete list on pages 9–10 of this manual.

 HBZ3024	 HBZ3030	 HBZ3031	 HBZ3032
 HBZ3033	 HBZ3034	 HBZ3035	 HBZ3036
 HBZ3037	 HBZ3038	 HBZ3039	 HBZ3040
 HBZ3041	 HBZ3042	 HBZ3043	 HBZ3045
 HBZ3046	 HBZ3047	 HBZ3072	 HBZ3049
 HBZ1010	 HBZ1011	 HBZ5539	 HBZ1026

## Replacement and Upgrade Parts

Keep your Mini Mauler running at peak performance with genuine HobbyZone® replacement and upgrade parts.

Parts are available online at [www.modelflight.com.au](http://www.modelflight.com.au)

## Replacement and Upgrade Parts

Item #	Description	Price	Item #	Description	Price
HBZ3012	Decal Sheet: Mini Mauler MT . . . . .	\$4.99	HBZ3073	E-Clip Bag: Mini Mauler. . . . .	\$1.50
HBZ3015	Instruction Manual: Mini Mauler MT . . . . .	\$9.99	HBZ3074	Wheel Nuts(2) & Right/Left Wheel Adapter . . . . .	\$1.99
HBZ3016	Painted Body: Black . . . . .	\$19.99	HBZ3080	Chrome Front Wheels (2) . . . . .	\$4.99
HBZ3017	Painted Body: Red . . . . .	\$19.99	HBZ3081	Chrome Rear Wheels (2) . . . . .	\$2.49
HBZ3018	Painted Body: Blue . . . . .	\$19.99	HBZ3085	Tire w/ Foam Inserts (2) . . . . .	\$9.99
HBZ3020	Clear Body Set: Mini Mauler MT . . . . .	\$11.99	HBZ3086	Rear Axle (2). . . . .	\$8.49
*HBZ3024	Front/Rear Wheels w/Mounted Tires (Chrome) . . . . .	\$19.99	HBZ3087	Body Clips (10) . . . . .	\$1.50
*HBZ3030	Main Chassis Set . . . . .	\$8.99	HBZ3091	Crystal Set: 26.995 . . . . .	\$5.99
*HBZ3031	Front/Rear Suspension Arm Set . . . . .	\$6.99	HBZ3092	Crystal Set: 27.045 . . . . .	\$5.99
*HBZ3032	Ball Cap Set. . . . .	\$1.99	HBZ3093	Crystal Set: 27.095 . . . . .	\$5.99
*HBZ3033	Front/Rear Shock Tower Set . . . . .	\$4.79	HBZ3094	Crystal Set: 27.145 . . . . .	\$5.99
*HBZ3034	T-Bar Set . . . . .	\$1.99	HBZ3095	Crystal Set: 27.195 . . . . .	\$5.99
*HBZ3035	Spindle & Carrier Set . . . . .	\$5.49	HBZ3096	Crystal Set: 27.255 . . . . .	\$5.99
*HBZ3036	Rear Gear Box Set . . . . .	\$5.99	HBZ3097	Servo Assembly. . . . .	\$11.99
*HBZ3037	Differential Gear Bag . . . . .	\$6.99	HBZ3098	Servo Gear Set . . . . .	\$1.99
*HBZ3038	Pinion Gear Bag. . . . .	\$2.49	HBZ3099	Battery Box Holder . . . . .	\$4.50
*HBZ3039	Body Post Set. . . . .	\$2.49	HBZ3061	Transmitter no crystal . . . . .	\$29.99
*HBZ3040	Assembled Damper Set (2) . . . . .	\$11.99	HBZ3051	RX/ESC no crystal . . . . .	\$49.99
*HBZ3041	Front Bumper Set. . . . .	\$5.49			
*HBZ3042	Rear Bumper Set . . . . .	\$4.50			
*HBZ3043	Plastic Bushing Set . . . . .	\$2.50			
HBZ3044	Motor Plate . . . . .	\$5.49			
*HBZ3045	Suspension Pin Bag . . . . .	\$2.99			
*HBZ3046	Front Axle . . . . .	\$6.99			
*HBZ3047	Pin Set (Gear Box & T-bar) . . . . .	\$5.99			
HBZ3048	Screw Set (All screws) . . . . .	\$1.99			
HBZ3067	Stock Motor. . . . .	\$8.99			
HBZ3069	Transmitter Antenna. . . . .	\$5.99			
HBZ3070	TX Steering Wheel . . . . .	\$2.99			
HBZ3071	Jump Ramp (4) . . . . .	\$6.99			
HBZ3072	Camber & Steering Links . . . . .	\$3.99			

## Optional Parts

Item #	Description	Price
*HBZ3049	BB Upgrade Kit . . . . .	\$12.99
HBZ3068	Upgrade Motor . . . . .	\$14.99
HBZ3075	Front Wheels (2) (Yellow) . . . . .	\$2.99
HBZ3076	Rear Wheels (2) (Yellow). . . . .	\$2.99
*HBZ1010	4.8V 600mAh Ni-MH Battery Pack . . . . .	\$14.99
*HBZ1011	6.0V 600mAh Ni-MH Battery Pack . . . . .	\$17.99
*HBZ5539	2 1/2 hour wall charger w/timer. . . . .	\$9.99
*HBZ1026	DC Peak Charger . . . . .	\$19.99

## HZ-02 Radio System

Your Mini Mauler™ comes equipped with a fully proportional HZ-02 2-channel radio system. Please take time to familiarize yourself with its functions and adjustments before driving your Mini Mauler for the first time.

- A. Steering Wheel: Directional (left/right) control of your Mini Mauler.
- B. Throttle Trigger: Controls speed in forward and reverse, as well as brake/reverse.
- C. Antenna: Sends signal from transmitter. *Note: The antenna should always be fully extended when running your Mini Mauler.*
- D. Power Switch: Turns the transmitter “on” or “off.” *Note: The transmitter should always be turned on first, before turning on the truck, and turned off only after the truck is turned off.*
- E. LED: The top light (green) assures you of adequate battery power. The bottom light (red) indicates signal strength.
- F. Steering Trim: This is used to adjust the “hands off” tracking of the Mini Mauler when no steering control is given to the wheel.
- G. Throttle Trim: This is used to stop the motor when the throttle trigger is at neutral.
- H. Transmitter Crystal: This, along with the crystal in the receiver, determines the frequency/channel you are on. *Note: Both the transmitter and receiver crystal channel must match for the system to operate properly.*
- I. Battery Tray: This is used to cover and hold the transmitter batteries in place.

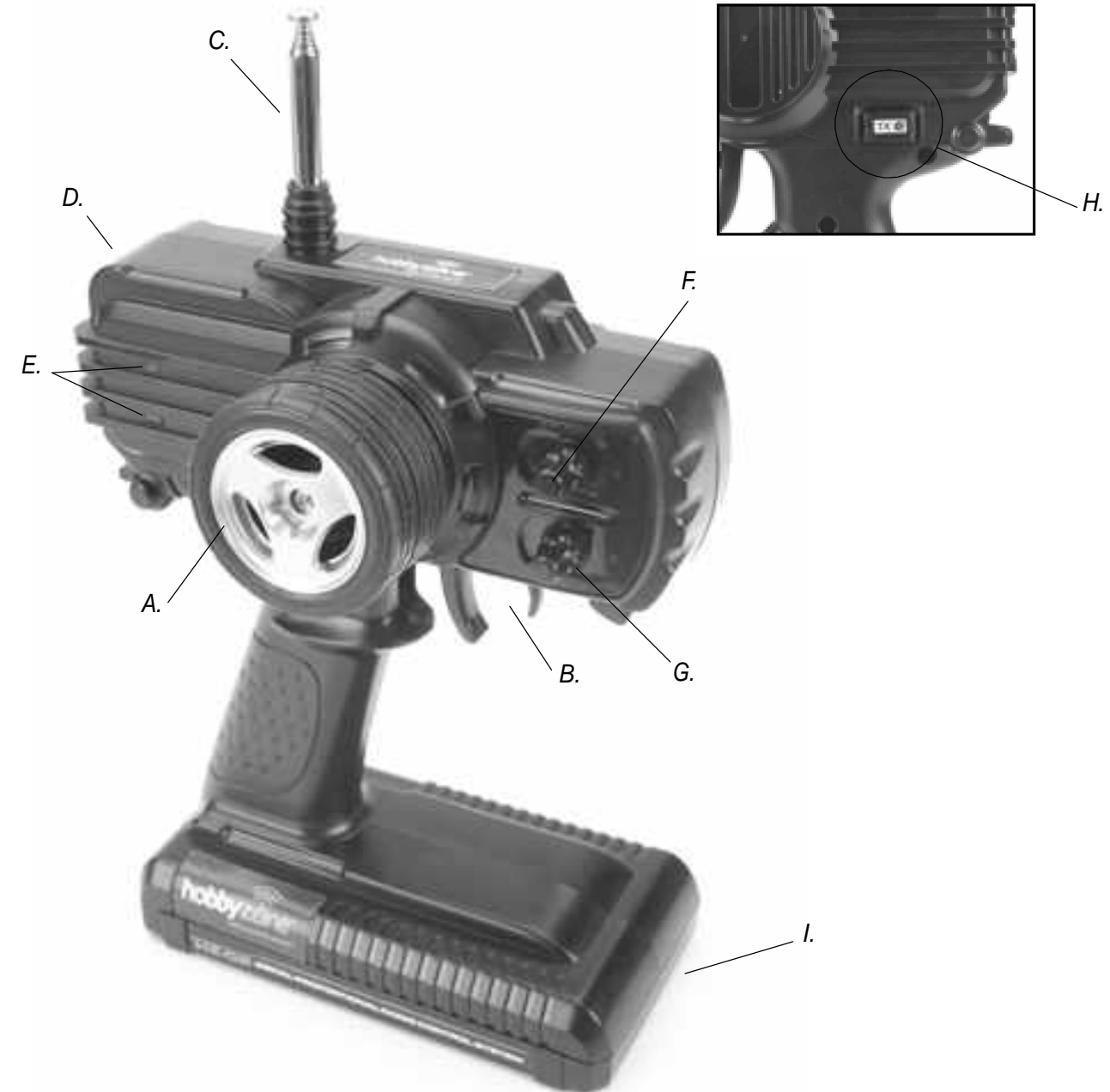

\*Pictured on page 10

## TROUBLESHOOTING GUIDE

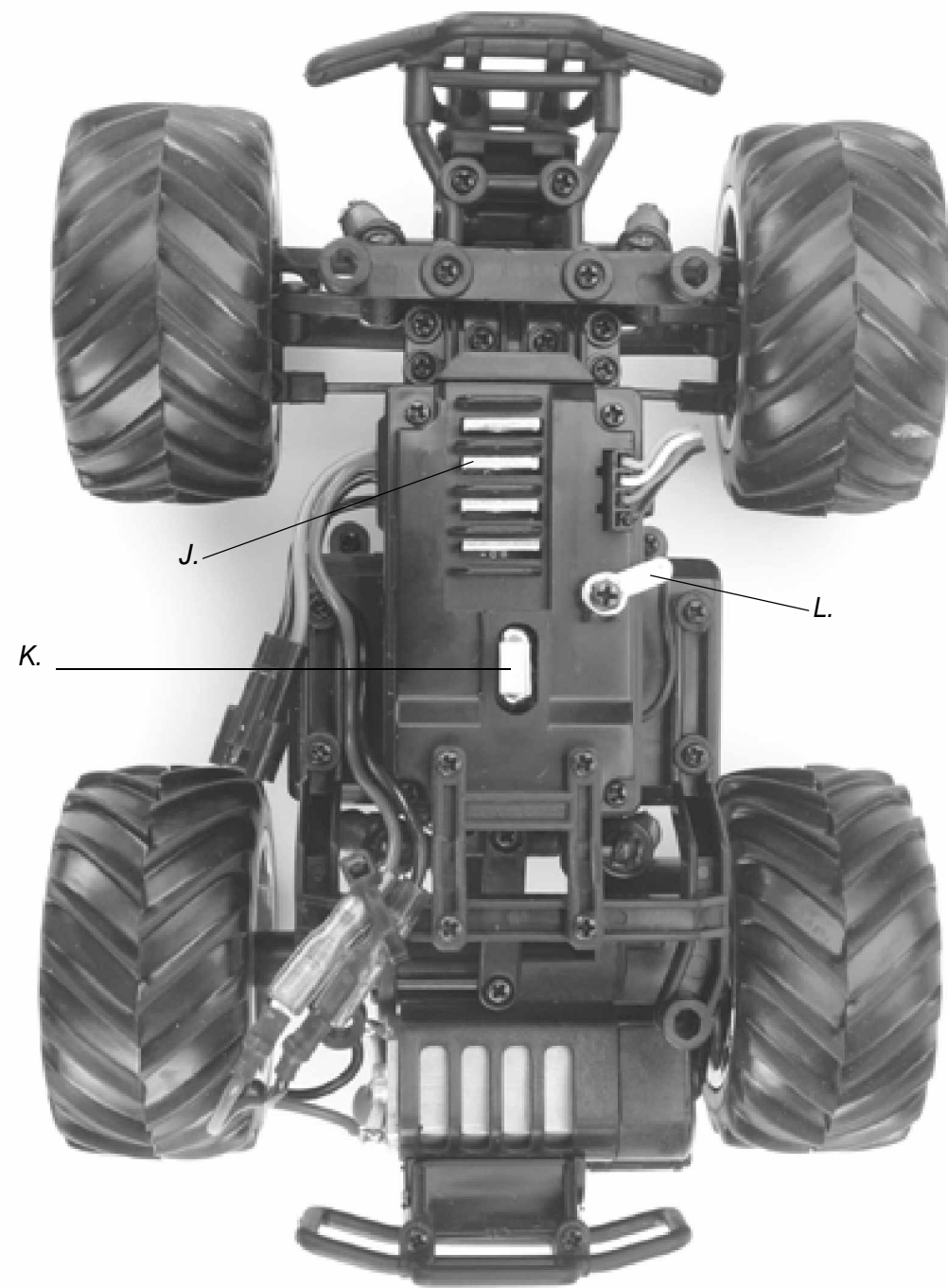

Problem	Possible Cause	Solution
Does not operate	<ol style="list-style-type: none"> <li>1. Transmitter (TX) "AA" Alkaline batteries are depleted</li> <li>2. Transmitter (TX) batteries are installed incorrectly</li> <li>3. Electrical connection not made</li> <li>4. Motor batteries are depleted</li> <li>5. Receiver switch not turned on</li> </ol>	<ol style="list-style-type: none"> <li>1. Replace transmitter (TX) "AA" Alkaline batteries</li> <li>2. Check polarity of transmitter batteries</li> <li>3. Push battery connectors together until they click</li> <li>4. Replace/recharge motor battery</li> <li>5. Turn receiver switch on</li> </ol>
Steering does not work	<ol style="list-style-type: none"> <li>1. Servo has come unplugged from receiver</li> <li>2. Servo is damaged</li> </ol>	<ol style="list-style-type: none"> <li>1. Check to see that the plug is in all the way inside the receiver</li> <li>2. Replace or repair servo</li> </ol>
Only turns in one direction	<ol style="list-style-type: none"> <li>1. Servo gear damaged</li> </ol>	<ol style="list-style-type: none"> <li>1. Replace the gear</li> </ol>
Motor will not run	<ol style="list-style-type: none"> <li>1. Electronic Speed Control (ESC) is damaged</li> <li>2. Connectors to motor are loose</li> <li>3. Wire to motor has come unsoldered or has broken</li> </ol>	<ol style="list-style-type: none"> <li>1. Call product support technician</li> <li>2. Plug in connectors</li> <li>3. Repair/replace as needed</li> </ol>
Poor runtime/performance	<ol style="list-style-type: none"> <li>1. Batteries are low</li> <li>2. Motor issues</li> <li>3. Gear mesh is too tight</li> </ol>	<ol style="list-style-type: none"> <li>1. "AA" Alkaline batteries need replaced, or if Ni-MH, need recharged</li> <li>2. Replace motor</li> <li>3. Reset gear mesh</li> </ol>
Poor range	<ol style="list-style-type: none"> <li>1. Transmitter (TX) "AA" Alkaline batteries are low</li> <li>2. Transmitter (TX) antenna is not up</li> <li>3. Motor battery is low</li> </ol>	<ol style="list-style-type: none"> <li>1. Replace transmitter (TX) "AA" Alkaline batteries</li> <li>2. Raise transmitter (TX) antenna</li> <li>3. Replace/recharge batteries</li> </ol>

### HZ-02 Radio System (continued)

**J Receiver/Electronic Speed Control Unit:** This unit receives the signal sent out from the transmitter and controls the power (and speed) of the motor.

**K. Receiver Crystal:** This, along with the crystal installed in the transmitter, determines the frequency/channel you are on.

*Note: Both the transmitter and receiver crystal channel must match for the system to operate properly.*

**L. Antenna:** This receives the signal from the transmitter.

**M. Power Switch:** Turns the receiver "on" or "off." Note: The transmitter should always be turned on first, before turning on the truck, and turned off only after the truck is turned off.

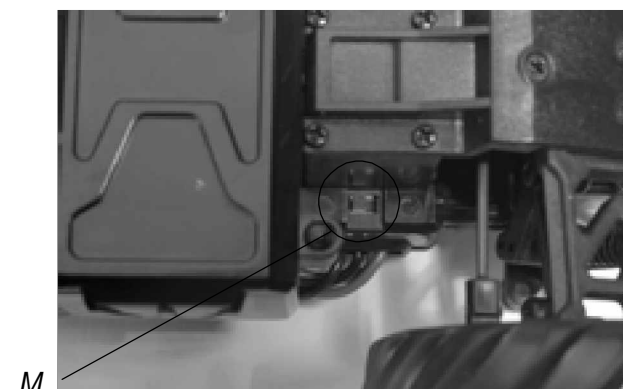

*Bottom of Truck*

## Switching Channels

If you want to change the channel your Mini Mauler uses, you must replace both the transmitter and receiver crystals using one of the following available sets. Each set includes a transmitter and receiver crystal for a given channel.

### Crystal Sets:

Channel 1, 26.995 (HBZ3091)

Channel 3, 27.095 (HBZ3093)

Channel 5, 27.195 (HBZ3095)

Channel 2, 27.045 (HBZ3092)

Channel 4, 27.145 (HBZ3094)

Channel 6, 27.255 (HBZ3096)

## Replacing the Wheels

Different colored wheels are available to customize your Mini Mauler with a different color. To remove the stock wheel/tire, simply use a 5.5mm nut driver to loosen the securing nut and remove the tire. Place the nuts somewhere they will not be lost as they are very small. When you have reinstalled the wheel, tighten the wheel nut securely before running your Mini Mauler again.

## Pinion Gear and Motor Access

You may want to increase the performance of your Mini Mauler by adding some optional parts, such as a different pinion gear or the upgrade motor. You may, in time, find it necessary to replace these stock parts.

### To change/replace pinion and/or motor:

1. With radio system off, remove both rear wheels with 5.5mm nut driver.
2. Remove 2 Phillips screws in gear box cover. This will give you access to the pinion.
3. Remove the 2 Phillips screws that secure the motor in the motor plate.
4. Carefully slide the motor back. If replacing the motor, unplug the bullet connectors at this point.
5. Use small flathead screwdriver or pliers to carefully pry off pinion from motor.
6. Install pinion (new pinion if necessary) in same position as the one that was removed.
7. Slide motor back in (reconnect bullet connectors if necessary) and reinstall 2 screws that secure motor to the motor plate. Proceed to "Setting the Gear Mesh" section below.

*Note:* 8T pinion offers more torque for quicker acceleration, but a little less top speed.  
10T pinion comes stock, and offers best mix of torque and speed.  
12T pinion offers the best top speed, but not as quick acceleration and a little less runtime.

## Setting the Gear Mesh

After you have replaced the motor and/or pinion, keep the screws that secure the motor slightly loose. Slide the motor forward allowing the pinion gear to mesh properly with the spur gear. When seated correctly, there should not be too much noise when the wheels are spun forward. Once the gear mesh is set, tighten the motor screws (but not overly so) and replace the gear box cover prior to running your Mini Mauler again.

## Battery Options

Your Mini Mauler comes with 4 "AA" Alkaline batteries included. These batteries offer good performance and runtime (about 30 minutes), but cannot be recharged. You can simply replace these batteries with standard "AA" Alkaline batteries if you so choose. HobbyZone also offers two rechargeable hop-up battery options:

- HBZ1010: 4-cell (4.8V) 600mAh Ni-MH battery pack: This pack offers better performance than the included "AA" Alkaline batteries. In the long run, it is also a better value since they can be recharged. Choices of chargers are either the 2 ½ hour AC charger (HBZ5539) or DC Peak charger (HBZ1026). The HBZ1026 will charge your battery in approximately 30 minutes.
- HBZ1011: 5-cell (6.0V) 600mAh Ni-MH battery pack. This rechargeable battery pack is recommended for those people who crave higher speeds. You will have a little less runtime with this battery pack than with the 4-cell. Keep in mind that the faster you go, the easier it is to have roll-overs and crashes which could cause some damage to your Mini Mauler. It takes some practice with throttle management to master running this battery pack with your truck, but it is well worth it! You must use the DC Peak Charger (HBZ1026) to properly charge this high-performance battery pack.

## Installing the Transmitter Batteries

Your Mini Mauler™ includes the 8 batteries needed to power the transmitter. To install them:

1. Remove the battery compartment cover at the bottom of the transmitter.
2. Install the 8 "AA" heavy duty batteries in the transmitter battery tray as indicated by the battery diagram.
3. Replace the battery compartment cover.
4. Raise the antenna.
5. Turn the switch "on" to ensure the radio is working and the batteries have been installed correctly. Keep radio on until you have completed testing the receiver (next step).

## Installing the Receiver Batteries and Testing Radio System

Your Mini Mauler comes with 4 "AA" Alkaline batteries to power the truck. To install them:

1. Open the battery cover at the bottom of the truck by removing 2 body pins.
2. Install the 4 "AA" Alkaline batteries into the battery tray as indicated by the battery diagram.  
\*(An optional rechargeable 600mAh Ni-MH battery pack and charger are available. See the optional parts list on pages 9–10 of this manual.)
3. Close cover and install body pins to secure.
4. Turn the receiver switch "on" (verify the transmitter is "on" first).
5. Move the steering wheel and verify the wheels turn in the right directions.
6. Move the throttle trigger to make sure the electronic speed control functions correctly. *Note: Be sure to keep all hair, clothes, and other items away from spinning tires.*
7. Make sure the steering trim is set correctly. If the vehicle "wanders" in one direction, correct this by turning the steering trim knob in the opposite direction until the Mini Mauler tracks straight with no steering input.
8. Make certain the throttle trim is set correctly as well. The motor should not run when the trigger is in the neutral position. If an adjustment needs to be made, use very slight corrections for best results.

*\*Note: When replacing the stock "AA" Alkaline batteries with the 4- or 5-cell rechargeable Ni-MH packs, you will need to remove the "AA" battery tray prior to installing the upgrade pack.*

If it appears at any time that your radio system is not functioning properly, DO NOT drive it. Call Horizon Hobby Product Support at 1-877-504-0233 (Monday–Friday, 8 a.m. to 7 p.m. CST) for assistance.

## Running Your Mini Mauler

Once you are certain the radio and truck are functioning correctly, start out by running your Mini Mauler at slow speeds. Here are some helpful driving tips:

- If driving around other radio control cars, always check to see if anyone else is running on the same channel as you are. Let other RC drivers, especially those who may be using a 27MHz frequency, know what channel (1–6) you are on. This will help prevent you or someone else from having radio problems that could lead to product or property damage.
- While you can run your Mini Mauler on dirt, gravel, mulch, or just about any other surface, you will enjoy more runtime on smooth surfaces, such as concrete.
- When you are done running your Mini Mauler, turn off the truck battery first, then the transmitter.
- Clean your Mini Mauler with compressed air or a soft brush to remove excess dirt. Avoid using solvents or chemicals as they can actually wash dirt into moving parts and cause damage. Use a damp cloth to clean the body.
- Never run your Mini Mauler in the street.
- Once you are comfortable driving the Mini Mauler, you can try stunts, such as ramp jumping, by using the cardboard ramp that is included.
- If your Mini Mauler stops functioning correctly, check it for damage. If something is broken, replace the part before running the Mini Mauler again.
- When you notice your Mini Mauler is beginning to lose speed and power (after about 30 minutes with Alkalines), replace the batteries. Rechargeable Ni-MH battery packs (HBZ1010 4-cell pack or HBZ1011 5-cell pack) are also available. They add speed and are more cost effective in the long run. The 4-cell pack requires either the 2 ½ hour AC charger (HBZ5539) or DC Peak Charger (HBZ1026) that can recharge a pack in about 30 minutes. The 5-cell pack requires the DC Peak Charger.

# Mini Mauler Replacement/Optional Parts Exploded View Listing

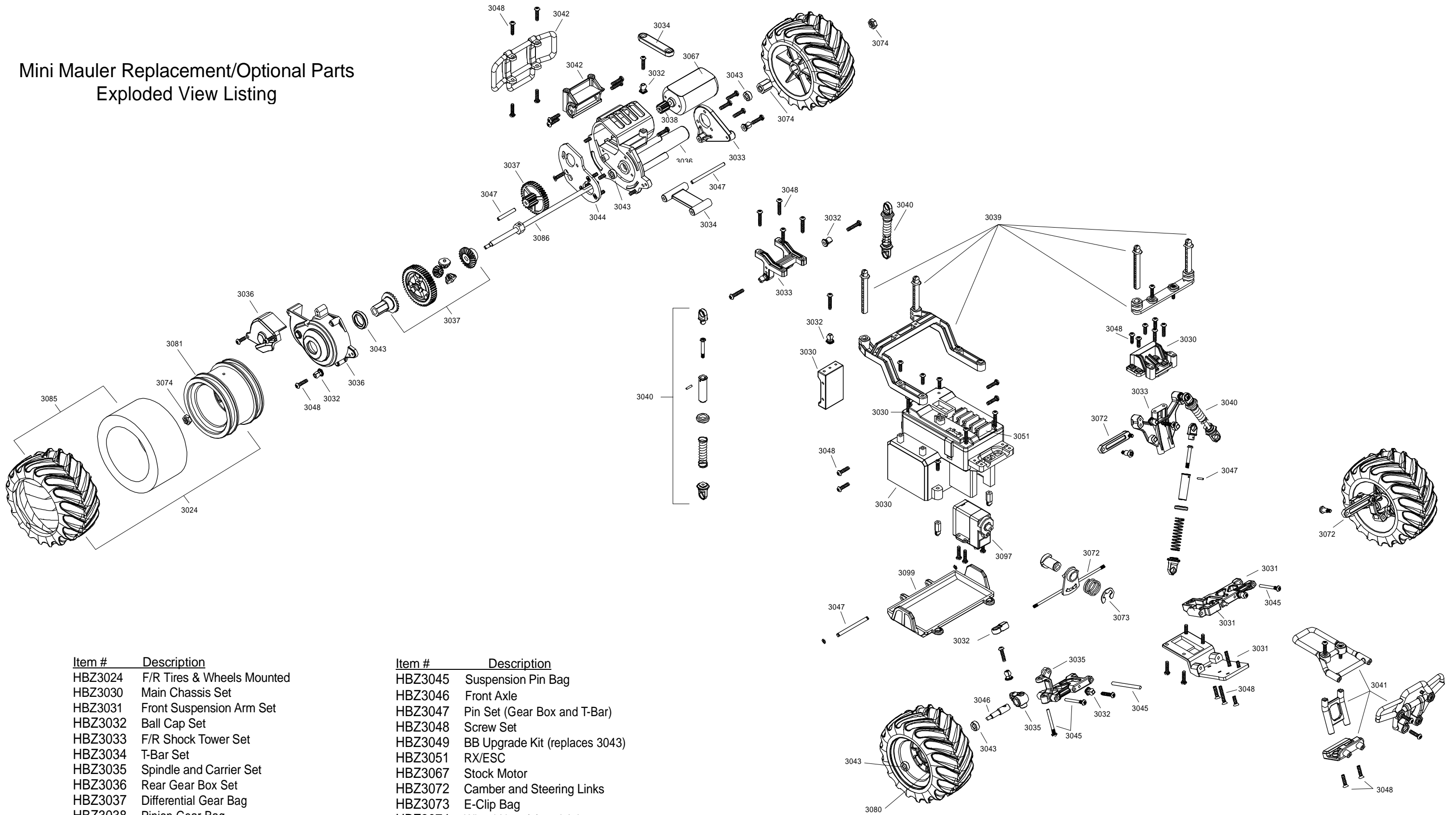

Item #	Description
HBZ3024	F/R Tires & Wheels Mounted
HBZ3030	Main Chassis Set
HBZ3031	Front Suspension Arm Set
HBZ3032	Ball Cap Set
HBZ3033	F/R Shock Tower Set
HBZ3034	T-Bar Set
HBZ3035	Spindle and Carrier Set
HBZ3036	Rear Gear Box Set
HBZ3037	Differential Gear Bag
HBZ3038	Pinion Gear Bag
HBZ3039	Body Post Set
HBZ3040	Damper Set (assembled)
HBZ3041	Front Bumper Set
HBZ3042	Rear Bumper Set
HBZ3043	Plastic Bushing Set
HBZ3044	Motor Plate

Item #	Description
HBZ3045	Suspension Pin Bag
HBZ3046	Front Axle
HBZ3047	Pin Set (Gear Box and T-Bar)
HBZ3048	Screw Set
HBZ3049	BB Upgrade Kit (replaces 3043)
HBZ3051	RX/ESC
HBZ3067	Stock Motor
HBZ3072	Camber and Steering Links
HBZ3073	E-Clip Bag
HBZ3074	Wheel Nuts (4) and Adaptor
HBZ3080	Chrome Front Wheels (2)
HBZ3081	Chrome Rear Wheels (2)
HBZ3085	Tire and Foam (2)
HBZ3087	Body Clips (10)
HBZ3097	Servo Assembly
HBZ3099	Battery Box Holder