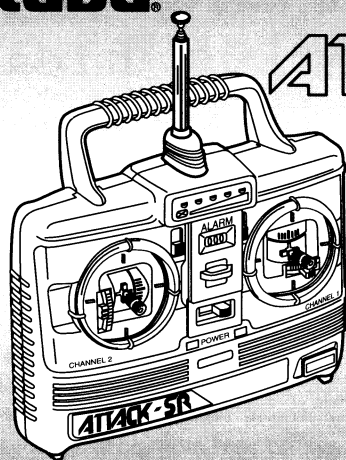

**Futaba**

D60803

**ATTACK-SR****INSTRUCTION  
MANUAL****FOREWORD**

Thank you for selecting the Futaba ATTACK-SR. The ATTACK-SR is a 2-channel digital proportional R/C set for R/C cars, boats (yachts), and other models. To enjoy its functions to the fullest and to ensure safe operation, please read this manual carefully before using your set. After reading this manual, store it in a safe place. If you encounter any difficulties while using your set, please refer to the appropriate sections in this manual. In addition to this manual, please read all of the manuals included with your car, engine and other related equipment you may use.

This manual covers "SET CONTENTS", "PREPARATIONS" before installation of the R/C set in the model, R/C set "ADJUSTMENTS", "PRECAUTIONS WHEN INSTALLING" the R/C set in the model, "OPERATIONS" of the R/C set, "OPERATING PRECAUTIONS", "USING OPTION PARTS", and "RATINGS" of the R/C set. If your R/C set appears to be faulty, check the "WHEN YOU THINK THE SET IS FAULTY" section. If the set is faulty, send it to be serviced in accordance with "REPAIR SERVICE".

*(IMPORTANT) To help ensure safe use, pay particular attention to the precautions printed throughout this manual and indicated by an exclamation mark **!**.*

**(ATTENTION)****1. Application of Product**

This product is not intended for use in any application other than for the control of models for hobby and recreational purposes. This product is subject to regulations of the Ministry of Radio/Telecommunications and is restricted under Japanese law to such purposes. The laws of other countries may similarly restrict the use of this product. Futaba is not responsible for any use that is not in compliance with applicable law.

**2. Exportation of Product**

If the product is exported from Japan, the prior approval of the Ministry of Radio/Telecommunications is required regarding the country of destination. If this product is reexported from other countries, it may be subject to restrictions on such reexport and prior approval of government authorities may be required.

**3. Modification, Adjustment & Replacement of Parts**

Futaba is not responsible for any use of this product that is not in compliance with applicable law and disclaims all responsibility for any modification or alteration of the product, including the incorporation of the product into other products by third parties, that is not in compliance with applicable law.

The following statement applies to only Ni-Cd battery system:

The product that you have purchased contains a rechargeable battery. The battery is recyclable. At the end of its useful life, under various state and local laws, it may be illegal to dispose of this battery into the municipal waste stream. Check with your local solid waste officials for details in your area for recycling options or proper disposal. (for U.S.A.)

The following statement applies to the receiver:

**THIS DEVICE COMPLIES WITH PART 15 OF THE FCC RULES. OPERATION IS SUBJECT TO THE FOLLOWING TWO CONDITIONS:**  
 (1) THIS DEVICE MAY NOT CAUSE HARMFUL INTERFERENCE, AND  
 (2) THIS DEVICE MUST ACCEPT ANY INTERFERENCE RECEIVED, INCLUDING INTERFERENCE THAT MAY CAUSE UNDESIRED OPERATION. (for U.S.A.)

- \* No part of this manual may be reproduced in any form without prior written permission.
- \* The contents of this manual are subject to change without prior notice.
- \* This manual has been carefully written, but please feel free to write to Futaba if you find that any corrections or clarification's that should be made.
- \* Futaba is not responsible for the results of the use of this product by the customer.
- \* Futaba and ATTACK are a registered trademark.

# SET CONTENTS

## TRANSMITTER FP-T2VR

### Battery level display

- The remaining battery capacity is displayed in five stages. (Refer to "PREPARATIONS")

### Battery alarm

- (Refer to "PREPARATIONS")

### Throttle stick

- (Refer to "OPERATIONS")
- Throttle stick neutral position modification (Refer to "PREPARATIONS")
- Changing throttle stick from self-neutral type to ratchet type (Refer to "USING A OPTION PARTS")

### Throttle trim

- (Refer to "OPERATIONS")

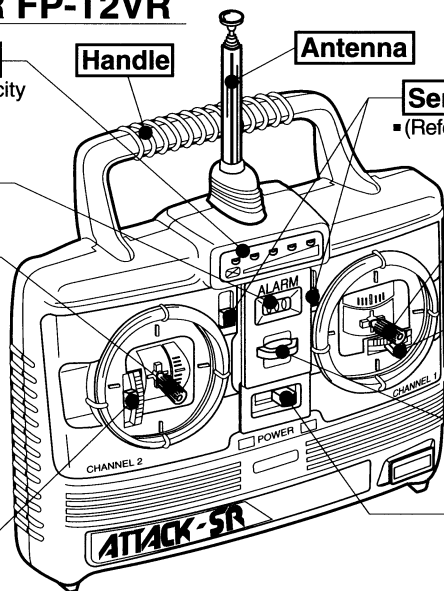

### Servo reversing switch

- (Refer to "ADJUSTMENTS")

### Steering stick

- (Refer to "OPERATIONS")

### Steering trim

- (Refer to "OPERATIONS")

### Hook

- Hook for neck strap.

### Power switch

- (Refer to "OPERATIONS")

## RECEIVER FP-R122JE / R112JE



- Thin and light weight.
- Built-in BEC ( power supply up to 8.4V )
- Replaceable crystal.

## SERVO FP-S3003 / S148

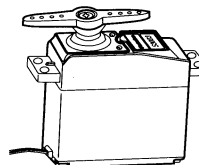

- Light weight.
- Torque: 3.2kg-cm (44.4oz-in)(S3003)
- Speed: 0.23sec/60degree(S3003)

## MOS FET ELECTRONIC SPEED CONTROL FP-MC210CB / FP-MC310CB

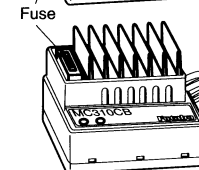
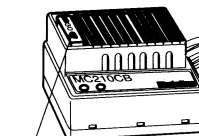

- With reverse and brake.
- Special heat sink provided as standard.
- Built-in neutral and HI point trimmers.
- Built-in heat protector and fuse.

## ATTACK-SR SET CONTENTS

	Transmitter	Receiver	Servo	FET E.S.C.	Accessories
2-SERVO SET	FP-T2VR(x1)	FP-R122JE(x1) or FP-R112JE(x1)	FP-S3003(x2) or FP-S148(x2)	MC210CB(x1)	Switch CSW-BN(x1) and others
SET w/MC210CB			FP-S3003(x1) or FP-S148(x1)		MC310CB(x1)
SET w/MC310CB					

\* A frequency board or flag is also supplied with each set.

## PREPARATIONS

### LOADING THE TRANSMITTER BATTERIES

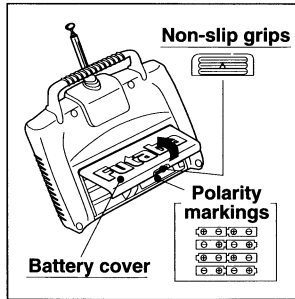

1. Open the battery cover in the arrow direction while pressing the non-slip cover grips.
2. Load the eight batteries in accordance with the polarity markings on the battery holder.
3. Re-fit the battery cover onto the transmitter.

### REMAINING BATTERY CAPACITY / ALARM DISPLAY

(LED display)

**When batteries replaced with new batteries,**  
 All LEDs light.

**When two green LEDs goes off,**  
 Approximately 140 minutes remaining (Mn. dry battery)  
 Approximately 120 minutes remaining (NiCd. battery)

**When all green LEDs goes off,**  
 Approximately 70 minutes remaining (Mn. dry battery)  
 Approximately 1 minutes remaining (NiCd. battery)

**When orange LED goes off,**  
 Approximately 20 minutes remaining (Mn. dry battery)  
 Approximately 0.5 minutes remaining (NiCd. battery)

**Battery alarm**  
 Indicated by the red LED flashing and the simultaneous sounding of the alarm buzzer. (sounds for several seconds)  
 Change the batteries immediately.

Note : The remaining time may differ with the type of battery, environment, etc.

### THROTTLE STICK NEUTRAL POSITION MODIFICATION (Change only when necessary)

The throttle stick neutral position is changed as described below only when you require a large throttle stick forward movement for extra control for engine car and when using a FET E.S.C., etc.  
 (The neutral position is set to center at the factory.)

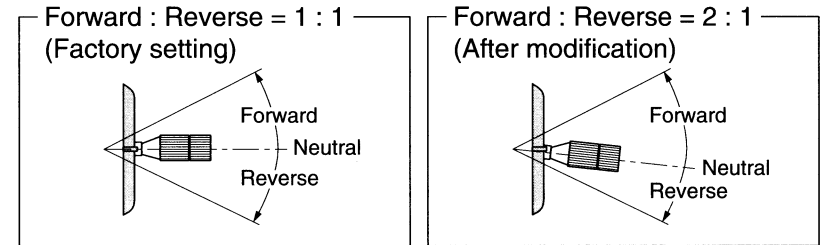

### MODIFICATION METHOD

(1) Remove the screws and open the rear case.  
 There are wires between the chassis and the rear case. Be careful not to pull these wires.

(2) Remove the stick spring and swing arm.

(3) Install the swing arm to the "2 : 1" side (out side) hole.

(4) Reinstall the spring and swing arm.

(5) Reinstall the rear case with the screws.

## TWO-SERVO SET CONNECTIONS

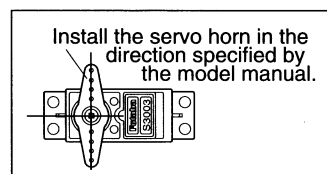
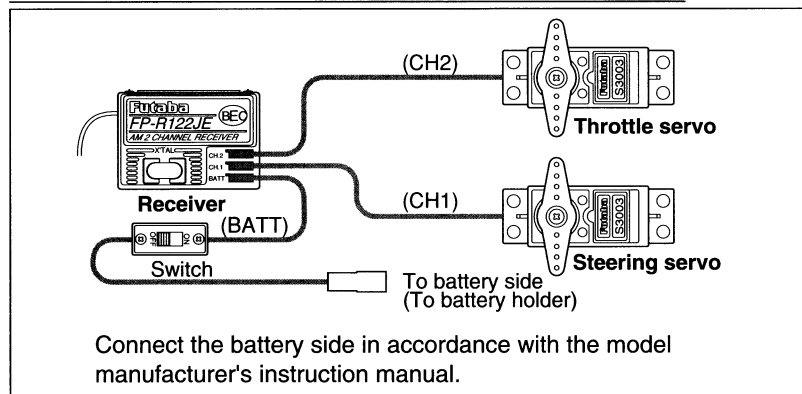

- In this state, install the servo horn in the direction specified by the model manual.

## REVERSING THE SERVO DIRECTION OF TRAVEL

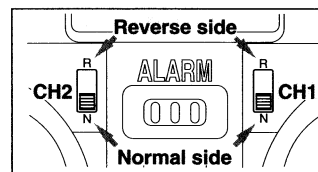

When the direction of travel of the servo is opposite the direction specified by the model manual, it can be reversed with the reversing switch.

## CONNECTION OF SET WITH FET E.S.C.

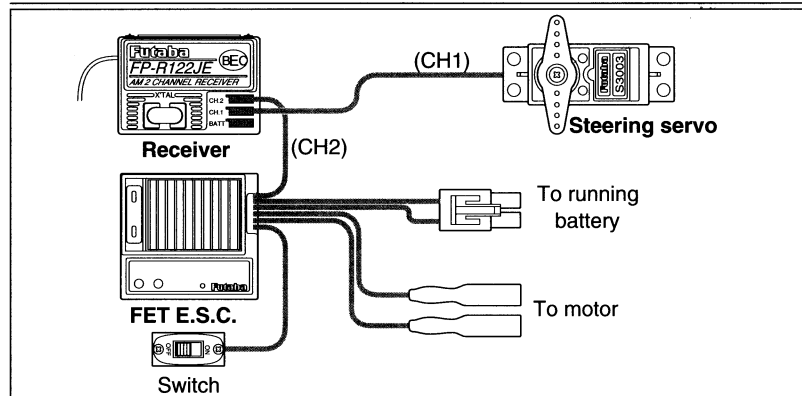

## ADJUSTMENTS

! Do not connect the running motor when making the settings described here.

## INSTALLING THE SERVO HORN

- Connect the receiver, servos, etc. and turn on the transmitter and receiver power switch.
- Set the transmitter trim lever to the center position. (The servos move to the neutral position.)

## FET E.S.C. ADJUSTMENT

\* Adjust the FET E.S.C. with the miniature screwdriver supplied with the set.

### (Preparations)

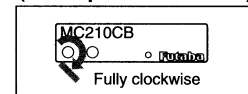

- Set the transmitter throttle reversing switch to the "N" (normal) position.
- First, turn the HI point trimmer fully clockwise.

### (Neutral adjustment)

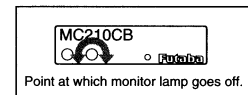

- Set the throttle stick to the neutral position.
- Set the neutral trimmer to the point at which the monitor lamp goes off. (The point at which the lamp switches from a fast flashing to off is the neutral point.)

### (Hi point adjustment)

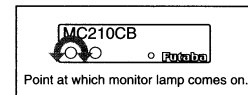

- Hold the throttle stick in a position just before the maximum speed position.
- Set the HI point trimmer to the point at which the monitor lamp comes on.

(The point at which the monitor lamps switches from a fast flashing to a steady light is the HI point.)

### Monitor lamp display

Reverse side	: Slow flashing
Neutral point	: Off
Forward side	: Fast flashing
HI point	: On

## PRECAUTIONS WHEN INSTALLING

### RECEIVER

\* Although the receiver antenna appears to be long, do not cut it. Cutting it will shorten the range. The receiver will also be affected by noise and interference. When the antenna is too long, wrap it around a piece of cardboard cut to the shape shown in the figure and mount it near the receiver. The effect will be smaller than cutting the wire.

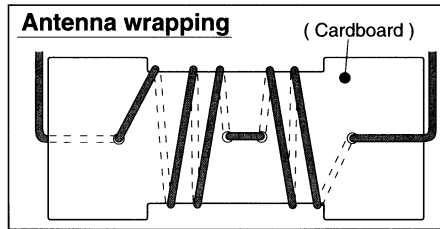

\* When mounting the antenna, keep it as far away as possible from Nicd battery, FET E.S.C., motor, and other parts which carry a large current.

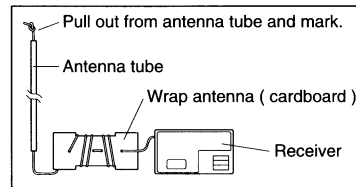

\* Use thick double-sided tape to install the receiver so that vibrations are not transmitted directly to it and the receiver will not move.

\* When using the receiver in a boat or other place where it may be splashed with water, place the receiver in a plastic bag and secure the open end of the bag with a rubber band. After use, immediately remove the receiver from the plastic bag so that it may dry if it has become damp.

### SERVO

\* When replacing the servo horn, use the specified servo horn set screw. If a screw longer than necessary is used, the inside of the servo may be damaged.

\* After mounting the servos, make sure that the pushrods do not bind and are not loose when the servos are operated over their full travel. If unreasonable force is applied to the servo, the life of the servo will be adversely affected and the battery will run down quickly.

### FET E.S.C.

\* When using a commercial motor checker, always disconnect the connector between the FET E.S.C. and the motor. If it is not disconnected, the E.S.C. may be destroyed.

\* Install the FET E.S.C. so that the heat sink does not touch an aluminum or carbon chassis or other parts through which conducts electricity. Touching may cause shorting with other circuits.

\* To make full use of the characteristics of the FET E.S.C., install the heat sink in a well ventilated place.

## OTHERS

\* Always solder noise suppressing capacitors to the running motor. If these capacitors are not connected or the solder comes loose, the receiving range will be shortened or erroneous operation may occur.

\* If vibration causes metal parts to touch each other, reception will be adversely affected.

\* Do not bundle together the motor connection wires and the connection wires to the receiver. The receiver will be affected by noise.

### Noise suppressing capacitor

Ceramic capacitor  
approx. 0.01 $\mu$ F

\* Install at two places, at least.

\* The installation method depends on the motor.

\* Install between the terminal and case.

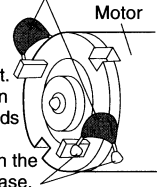

## CHECK

After mounting the receiver and others to the model, place the model on a stand so that it cannot take off and check if the servos and FET E.S.C. accurately follow operation of each stick.

## OPERATIONS

### STICK/TRIM OPERATION AND VEHICLE MOVEMENT

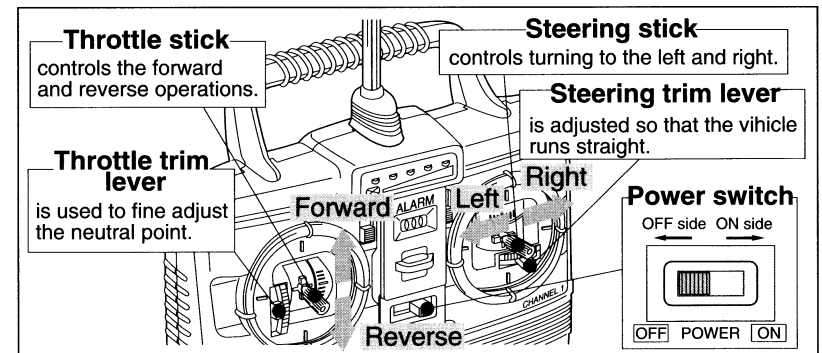

## FREQUENCY BOARD/FLAG

When operating the digital proportional R/C set, always install the frequency board or flag. Interference can be prevented by learning the frequency (channel No.) used by other operators.

# OPERATING PRECAUTIONS

## (IMPORTANT)

To use your R/C set safely, please observe the following precautions:

- ! When turning on the power, first turn on the transmitter power, then turn on the receiver power. When turning off the power, first turn off the receiver power, then turn off the transmitter power. (For engine models, stop the engine before turning off the receiver power.)  
If the power is turned on or off in the reverse order, the receiver power will remain on and interference is possible.
- ! Extend the transmitter antenna to its full length. If the antenna is short, the transmitting output power will be less and the range will be less.
- ! Operating two radios on the same frequency is extremely dangerous because it will cause loss of control. Before turning your system on, check that the frequency is not in use. Just because the modulation method or signal format (AM, FM, PCM, etc.) is different does not mean that operating on the same frequency is possible.
- ! When the vehicle, boat (yacht) is not in use, always disconnect the running Ni-cd battery connector. Otherwise the motor may start unexpectedly and is dangerous.
- ! Do not run the vehicle on rainy days and through puddles. Since the transmitter, receiver, servo, FET E.S.C., and other parts do not have a waterproof construction, water may enter them and cause erroneous operation.
- ! When placing the transmitter on the ground during running (cruising) preparations, be sure that the wind cannot knock it over. IF it is knocked over, the throttle stick may be pushed to the full speed position.

! Always test your digital proportional R/C set before running (cruising). Have an assistant hold the model or place the model on a stand so that it cannot take off, then check if the servos and FET E.S.C. follow the movement of their control sticks.

! **Course**  
Since the model runs at high speed, collisions are destructive and careful attention must be given to the presence of spectators, etc. Do not operate an R/C boat where there are row-boats. It is very dangerous because of collisions.  
In areas near high tension lines and communication facilities, consideration must be given to loss of control by radiowave interference.  
Because R/C radiowaves have a fairly long range, a place at least 3km from other R/C activities is necessary.

## USING OPTION PARTS

### CHANGING THROTTLE STICK FROM SELF-NEUTRAL TYPE TO RATCHET TYPE

Open the transmitter rear case and modify the throttle stick section. (For a description of how to open the case, see the "PREPARATIONS" section of this manual.)

\*The ratchet spring (sold separately) is necessary for this modification.

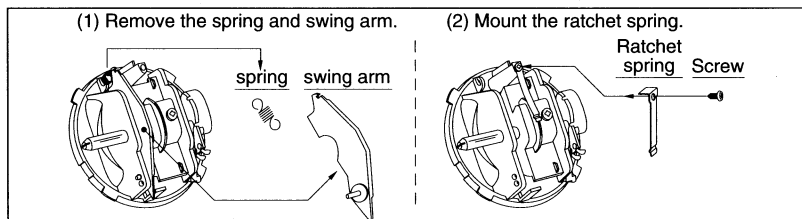

### Digital Proportional Frequency ( for U.S.A. )

\* The frequency of Futaba digital proportional sets can be changed within their own band. There are 2 different bands for you to choose from 27 MHz and 72-75 MHz. Please see chart listed below for specific frequency and its intended use. Please note there are specific frequencies allocated for aircraft only and surface only use.

\* The frequency can be changed within the same BAND. However, Futaba recommends that you return your system to our factory service department for frequency changing, as tuning may be necessary for proper operation. Changing frequency from one band to another is NOT possible.

Always change frequency flag when frequency is changed. The frequency flag is to be attached to the top of antenna and the channel designation to the base. (See Drawing)

\* It is illegal to change crystals on 72-75 MHz bands in the U.S.A. unless performed by a licensed technician.

### ( Antenna frequency flag )

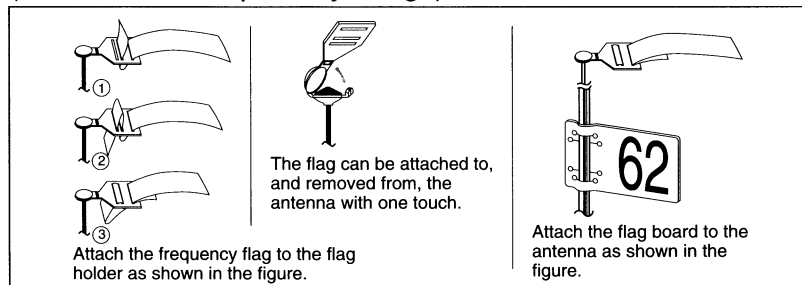

### ( Frequency, Channel No. Flag Color for U.S.A. )

#### 26-27MHz-Aircraft/car/boat

Frequency	Color	Frequency	Color
26.995	Brown	27.145	Yellow
27.045	Red	27.195	Green
27.095	Orange	27.255	Blue

#### 50/53 MHz-Aircraft/car/boat-Fcc Amature Licence required

(2 and 3 channels not produced on these frequencies).

Channel No.	Color	Channel No.	Color
50.800 RC00	Black-Brown	53.100	Black-Brown
50.820 RC01	Black-Red	53.200	Black-Red
50.840 RC02	Black-Orange	53.300	Black-Orange
50.860 RC03	Black-Yellow	53.400	Black-Yellow
50.880 RC04	Black-Green	53.500	Black-Green
50.900 RC05	Black-Blue	53.600	Black-Blue
50.920 RC06	Black-Violet	53.700	Black-Violet
50.940 RC07	Black-Gray	53.800	Black-Gray
50.960 RC08			
50.980 RC09			

#### 72MHz-Aircraft only

72.010 11	72.210 21	72.410 31	72.610 41	72.810 51
72.030 12	72.230 22	72.430 32	72.630 42	72.830 52
72.050 13	72.250 23	72.450 33	72.650 43	72.850 53
72.070 14	72.270 24	72.470 34	72.670 44	72.870 54
72.090 15	72.290 25	72.490 35	72.690 45	72.890 55
72.110 16	72.310 26	72.510 36	72.710 46	72.910 56
72.130 17	72.330 27	72.530 37	72.730 47	72.930 57
72.150 18	72.350 28	72.550 38	72.750 48	72.950 58
72.170 19	72.370 29	72.570 39	72.770 49	72.970 59
72.190 20	72.390 30	72.590 40	72.790 50	72.990 60

#### 75 MHz-Car/boat only

75.410 61	75.610 71	75.810 81
75.430 62	75.630 72	75.830 82
75.450 63	75.650 73	75.850 83
75.470 64	75.670 74	75.870 84
75.490 65	75.690 75	75.890 85
75.510 66	75.710 76	75.910 86
75.530 67	75.730 77	75.930 87
75.550 68	75.750 78	75.950 88
75.570 69	75.770 79	75.970 89
75.590 70	75.790 80	75.990 90

## RATINGS

### TRANSMITTER FP-T2VR

Operating system	Two-stick
Transmitting frequency	26, 27, 29, 40, 41, 72, or 75MHz band
Modulation	AM (Amplitude Modulation)
Power requirement	12V (8 penlight batteries or 8 Ni-cd batteries)
Current drain	160mA

### RECEIVER FP-R122JE / FP-R112JE

Receiving frequency	26, 27, 29, 40, 41, 72, or 75MHz band
Power supply voltage	4.8 to 8.4V (BEC built-in)
Current drain	30mA (4.8V), 10mA (8.4V) (no signal)
Dimensions	47.2x33.3x17.3mm / 47.6x31.5x15.7mm (1.86x1.31x0.68in / 1.87x1.24x0.62in)
Weight	16.6g / 20.5g (0.59oz / 0.72oz)

### SERVO FP-S3003 / S148

Control system	Pulse width control
Power requirement	4.8V or 6V (shared with receiver)
Current drain	8mA/6V (at idle)
Output torque	3.2kg-cm (44.4oz-in)(S3003), 3kg-cm(41.6oz-in)(S148)
Operating speed	0.23sec/60degree(S3003), 0.22sec/60degree(S148)
Dimensions	40.4x19.8x36mm (1.59x0.78x1.42in)
Weight	37.2g (1.31oz)(S3003), 44.4g(1.56oz)(S148)

### FET E.S.C. MC210CB/MC310CB

Voltage drop	Approx 0.52V/0.41V (at 20A) (between E.S.C. input and output)
Maximum current	30A/35A (fuse capacity)
Power requirement	7.2 to 8.4V
Regulator output(6V)	(210CB)3A max (310CB) 1A max (7.2V input), 0.5A max (8.4V input)
Dimensions	45.5x41.5x26mm (1.79x1.63x1.02in)
Weight	72.5g / 78g (2.56oz / 2.75oz)

## WHEN YOU THINK THE SET IS FAULTY

When the R/C set does not operate at all, the receiving range is short, or the R/C set operates intermittently or operates erroneously, first check the following items:

\* However, when the model does not run straight in neutral, takes off in neutral, or does not run fast when the throttle stick is set to maximum speed even when the trim lever are adjusted, recheck the "ADJUSTMENT" section of this manual.

Part	Check item	Remedy
Transmitter/receiver batteries	Dead battery	Change the batteries.
	Incorrect loading	Reload the batteries.
	Faulty contact	Correct the shape of the spring.
	Dirty contact	Wipe the contacts with a dry cloth.
Transmitter/receiver crystal	Missing	Insert the crystal.
	Wrong frequency	Match the transmitter and receiver frequency.
Receiver/servo connectors	Incorrect wiring	Switch the wiring.
	Disconnection	Reconnect the connector.
Receiver antenna/wiring to receiver	Motor or other part that carries a large current is near the wiring	Separate the wiring from other parts.
Motor	Noise suppressing capacitors not installed	Install noise suppressing capacitors.
FET E.S.C.	Blown fuse	Replace the fuse. (*1)
	Heat protector operation	Remove the cause/wait until cool.

(\*1) Observe the fuse capacity. (30A/MC210CB, 35A/MC310CB)

## REPAIR SERVICE

Before requesting repair, please refer to this instruction manual again and verify your settings. If you are still experiencing trouble, please request service as follows:

### (Address)

Your nearest Futaba dealer.

### (Repair information)

Describe the trouble in as much detail as possible.

- 1) Symptom: Including the state of the set when the trouble occurred.
- 2) Digital proportional set used: Transmitter, receiver, and servo model numbers.
- 3) Vehicle: Vehicle name and mounting conditions.
- 4) Your name, address, and telephone number.

### (Warranty contents)

Read the warranty card supplied with your set.

\*The warranty contents differ with geographic locations.



#### FUTABA CORPORATION

Makuhari Techno Garden Bldg., B6F 1-3 Nakase, Mihama-ku, Chiba 261-01, Japan  
Phone: (043) 296-5119 Facsimile: (043) 296-5124

#### FUTABA CORPORATION OF AMERICA

4 Studebaker, Irvine California 92718, U.S.A.  
Phone: 714-455-9888 Telex: 23-0691227 Facsimile: 714-455-9899