

6 CHANNEL RADIO CONTROL SYSTEM

**SKYSPORT 6**  
*Six*

**SKYSPORT 6**  
*Six*

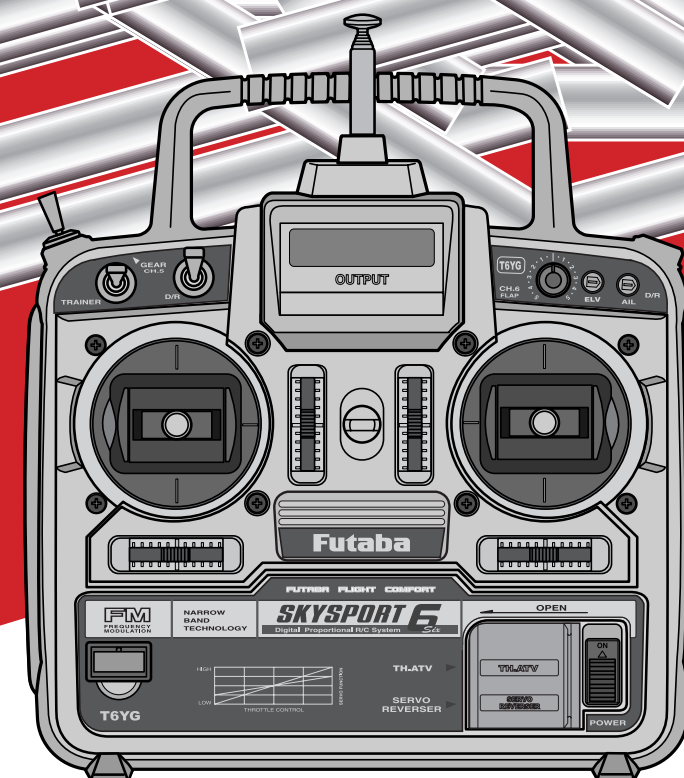

**6YG-FM**

**INSTRUCTION MANUAL**

1M23N04606  
FUTZ8562

© Copyright 2000



**Futaba**  
Digital Proportional R/C System

**Futaba**  
Digital Proportional R/C System

Thank you for purchasing a Futaba 6YG. Before using your 6YG, read this manual carefully and use your R/C set safely. After reading this manual, store it in a safe place.

See the glossary page 22 for a definition of the special terms used in this manual.

#### APPLICATION, EXPORT, AND RECONSTRUCTION

1. This product may be used for model airplane or surface use if on the correct frequency.
2. Exportation precautions
  - (a) When this product is exported from Japan, its use is to be approved by the Radio Law of the country of destination.
  - (b) Use of this product with other than models may be restricted by Export and Trade Control Regulations. An application for export approval must be submitted.
3. Modification, adjustment, and replacement of parts  
Futaba is not responsible for unauthorized modification, adjustment, and replacement of parts of this product.

The Following Statement Applies to the Receiver (for U.S.A.)

This device complies with part 15 of the FCC rules. Operation is subject to the following two conditions:

- (1) This device may not cause harmful interference, and
- (2) This device must accept any interference received, including interference that may cause undesired operation.

- No part of this manual may be reproduced in any form without prior permission.
- The contents of this manual are subject to change without prior notice.
- This manual has been carefully written. Please write to Futaba if you feel that any corrections or clarifications should be made.
- Futaba is not responsible for the misuse of this product.

## CONTENTS



<b>SAFETY INFORMATION.....</b>	<b>4</b>
Meaning of Special Markings .....	4
Precautions During Flight .....	4
NiCd Battery Charging Precautions .....	6
Storage and Disposal Precautions .....	7
Other Precautions .....	8
<b>BEFORE USE .....</b>	<b>9</b>
Set Contents .....	9
Name and Handling of Each Part.....	10
Transmitter Operation and Movement of Each Servo .....	14
<b>INSTALLATION AND ADJUSTMENT .....</b>	<b>15</b>
Connections .....	15
Adjustments .....	17
<b>USING OTHER FUNCTIONS .....</b>	<b>18</b>
Aileron/Elevator Dual Rate (D/R) Function .....	18
Non-slip Adjustable Lever Head .....	18
Stick Lever Spring Tension Adjustment .....	19
Trainer Function .....	19
<b>REFERENCE.....</b>	<b>20</b>
Ratings .....	20
Troubleshooting .....	21
Glossary .....	22
Repair Service .....	23

# SAFETY INFORMATION

To ensure safe use, observe the following precautions.

## Meaning of Special Markings

Pay special attention to safety at the parts of this manual that are indicated by the following marks.

Mark	Meaning
 <b>DANGER</b>	Procedures which may lead to a dangerous condition and cause death or serious injury to the user if not carried out properly.
 <b>WARNING</b>	Procedures which may lead to a dangerous condition or cause death or serious injury to the user if not carried out properly, or procedures where the probability of superficial injury or physical damage is high.
 <b>CAUTION</b>	Procedures where the possibility of serious injury to the user is small, but there is a danger of injury, or physical damage, if not carried out properly.

Symbol:



Prohibited



Mandatory

## Precautions During Flight

### **WARNING**

#### **Do not fly or turn "On" simultaneously on the same frequency.**

Interference will cause a crash.

Use of the same frequency will cause interference even if the modulation method (AM, FM, PCM) is different.

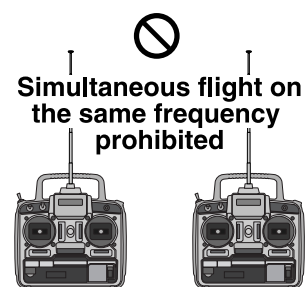

#### **Do not fly on rainy or windy days, or at night.**

Water will penetrate into the transmitter (Tx) and cause faulty operation, or loss of control, and cause a crash.



**⊘ Do not fly in the following places:**

- Near other R/C flying fields (within about 2.5miles [3km])
- Near people on the ground, or objects in the air
- Near homes, schools, hospitals, or other places where there are a lot of people
- Near high tension lines, high structures, or communication facilities

Radiowave interference and obstructions may cause a crash. A crash caused by trouble in the R/C set, or the model itself, may cause death or property damage.

**⊘ Do not fly when you are tired, sick, or intoxicated.**

Fatigue, illness, or intoxication will cause a loss of concentration or normal judgment and result in operation errors and a crash.

**! Extend the antenna to its full length.**

If the antenna is shortened, the effective range of the radio signal will be shorter.

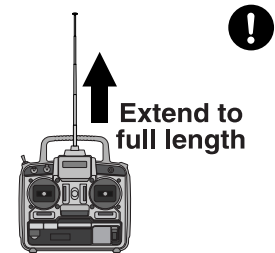

**! Always test the R/C set before use.**

Any abnormality in the R/C set, or model, may cause a crash.

Before starting the engine, check that the direction of operation of each servo matches the operation of its control stick. If a servo does not move in the proper direction, or operation is abnormal, do not fly the plane.



**! Check that the transmitter (Tx) antenna is not loose.**

If the transmitter antenna comes off during use, control will be lost and the model will crash.

## **⚠ CAUTION**

**⊘ When placing the transmitter (Tx) on the ground during flight preparations, be sure that the wind cannot knock it over.**

If it is knocked over, the throttle stick may be pushed to full throttle, the engine will speed up and create a very dangerous situation.

**⊘ Do not touch the engine, motor, or FET amp (speed control) during and immediately after use.**

They are hot and will cause a burn.

**! Turning on the power switch:**

**Set the transmitter (Tx) throttle stick to idle.**

- 1. Turn "On" the transmitter (Tx) power switch,**
- 2. Then turn "On" the receiver (Rx) power switch.**

**Turning off the power switch:**

**Stop the engine,**

- 1. Turn "Off" the receiver (Rx) power switch,**
- 2. Then turn "Off" the transmitter (Tx) power switch.**

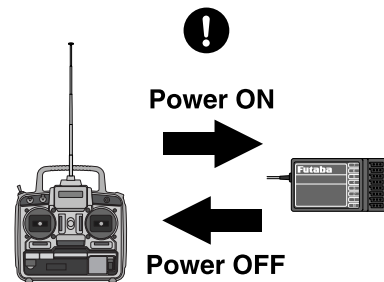

If the Tx power switch is turned off first, the engine may go to full throttle unexpectedly and cause an injury.

Idle: The stick direction in which the engine or motor runs at the slowest speed. (usually the down position)

**! When adjusting the R/C set, always stop the engine.**

If the engine suddenly goes to full throttle, it may cause an injury.

## Nicd Battery Charging Precautions

### **! WARNING**

**! Always charge the nicd batteries before each flight.**

If the battery goes dead during flight, the plane may crash or fly away.

**! Charge the R/C nicd battery with the standard charger, or fast field charger. (sold separately)**

Overcharging may cause burns, fire, injury, blindness, etc. due to overheating, breakage, electrolyte leakage, etc.



**Do not short the nicd battery connector terminals.**

Shorting the terminals will cause sparking and overheating and result in burns or fire.

**Do not drop or apply strong shock to nicd battery.**

The battery may short out and cause overheating or breakage and electrolyte leakage and result in burns or damage from chemical contents.



## Storage and Disposal Precautions

### **⚠ WARNING**

**Do not leave the R/C set, battery, model airplane, etc. within the reach of small children.**

Touching and operating the R/C set, or licking the battery, may cause injury or damage due to chemical content.

**Do not throw the nicd battery into a fire or heat the nicd battery. Also, do not disassemble or rebuild the nicd battery.**

Breakage, overheating, and electrolyte leakage may cause injury, burns, or blindness.

#### **Nicd Battery Electrolyte**

The electrolyte in a nicd battery is a strong alkali and can cause blindness if it gets in the eyes. If you get the electrolyte in your eyes, immediately wash your eyes with water and see a doctor. If you get the electrolyte on your skin or clothes, it may cause a burn. Immediately wash it off with water.

## **⚠ CAUTION**

- ⊘ Do not store the R/C set in the following places:**
- Where it is very hot (75°F [40C] or more) or very cold (18°F [-10C] or less).
  - Where the set will be exposed to direct sunlight.
  - Where the humidity is high.
  - Where there is strong vibration.
  - Where it is dusty.
  - Where there is steam and heat.

Storing the R/C set in the places listed above may cause distortion, corrosion and product failure.

- ! If the R/C set will not be used for a long time, remove the nicd batteries from the transmitter and the model and store them in a dry place.**

If the batteries are left in the transmitter and model, the battery electrolyte may leak out and damage the system, degrade the performance and shorten the life of the transmitter and model.

### **Nicd Battery Recycling (for USA only)**

Used nicd batteries are an important resource. Stick tape over the terminals and take the used batteries to a nicd battery recycling center.

The RBRC Battery Recycling Seal on the nickel-cadmium (Ni-Cd) battery that should be used in our product, indicates Hobbico is voluntarily participating in an industry program to collect and recycle these batteries at the end of their useful life, when taken out of service in the United States or Canada. The RBRC program provides a convenient alternative to placing used Ni-Cd batteries into the trash or the municipal waste system, which is illegal in some areas. Please call 1-800-822-8837 for information on Ni-Cd battery recycling in your area. Hobbico's involvement in this program is part of our commitment to preserving our environment and conserving our natural resources.



## **Other Precautions**

### **⚠ CAUTION**

- ⊘ Do not get fuel, oil, etc. on plastic parts.**  
The plastic may melt, discolor, become brittle and fail to function.

- ! Always use Genuine Futaba transmitters, receivers, servos, ESCs, nicd batteries, and other optional parts.**

Futaba is not responsible for damage, etc. caused by the use of parts other than Genuine Futaba parts.

Use the parts described in the instruction manual and catalogs.



# BEFORE USE

## Set Contents

After opening the carton, first check if the following items are provided.

**The set contents depend on the type of set, and these are the standard.**

Transmitter	T6YG	
Receiver	R127DF	R147F
Servo	S3003 (x4)	
	Servo horns Receiver switch Extension cord Small screwdriver and others	

If the set contents are incomplete, or if you have any questions, please contact the dealer.

# Name and Handling of Each Part

## Transmitter T6YG (Front Panel)

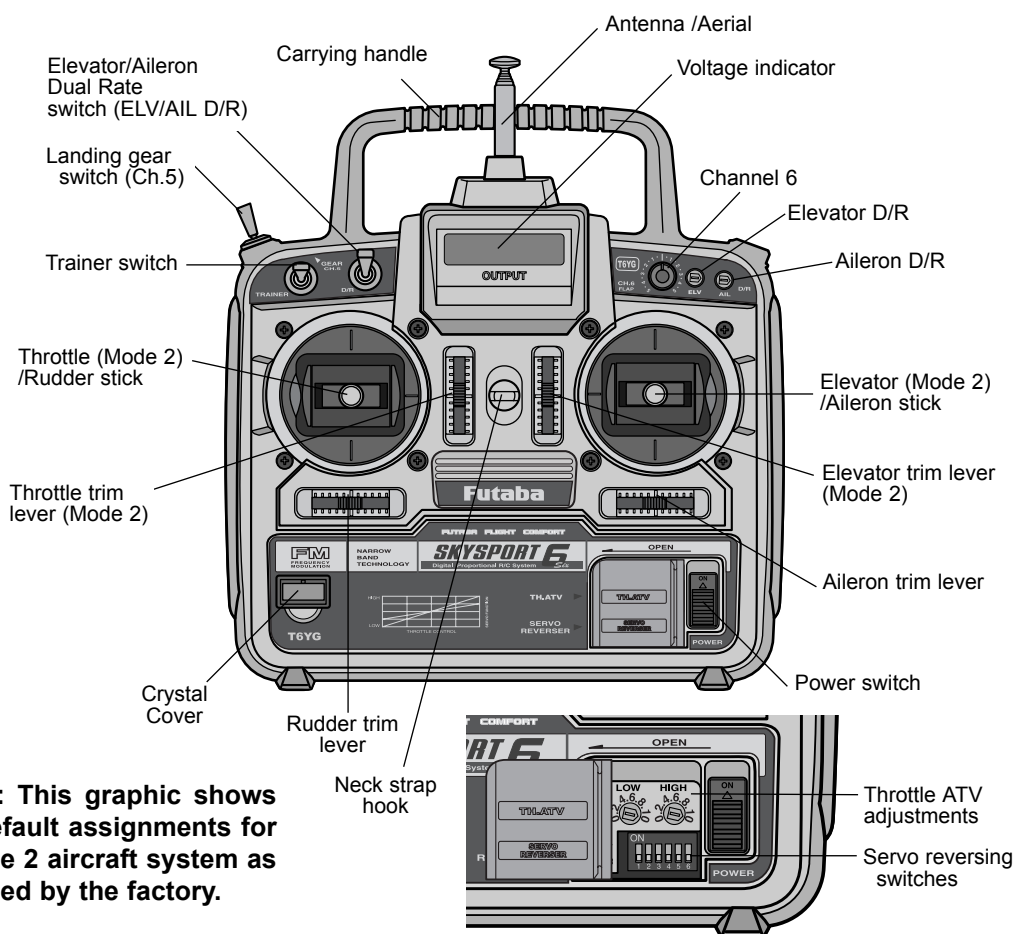

**NOTE:** This graphic shows the default assignments for a Mode 2 aircraft system as supplied by the factory.

**Power switch:** Turns the transmitter "On" or "Off". In the upper position, the power is turned "On".

**Voltage indicator:** This is an expanded scale voltmeter. It is not calibrated in volts. When the needle deflects to the boundary between the silver and red zones, recharge or replace the battery. Do not operate the transmitter if the needle descends into the red area.

**Antenna /Aerial:** Never operate the transmitter without extending this antenna or you may create interference to other modelers. This antenna is not intended to be removable.

**Aileron, Elevator, Throttle and Rudder stick:** Control each function. See page 14 for the transmitter operation instructions.

**Aileron, Elevator, Throttle and Rudder trim:** Used to shift the neutral or idle position of the each servo. As the throttle stick is moved up towards the high throttle position, the throttle trim will have less effect.

**Carrying handle:** Provides an easy means of transporting the transmitter.

**Neck strap hook:** Only clip the neck strap to this hook when neck strap use is required.

**Servo reversing switches:** Switches that reverse the direction of operation of the servos. The lower position is the normal side and the upper position is the reverse side.

Channel display

**1** :Aileron (CH1)    **3** :Throttle (CH3)    **5** :Landing gear (CH5)  
**2** :Elevator (CH2)    **4** :Rudder (CH4)    **6** :Flap (CH6)

<Operating direction display>

**REV** :Reverse side  
**NOR** :Normal side



**Landing gear switch:** Controls the raising and lowering of retractable landing gear. Not all models will use this function.

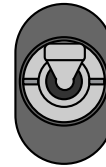

**Flap knob:** Controls the flap servo(CH6).

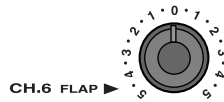

**Dual Rate switch (AIL. D/R/ELV. D/R):**  
**Dual Rate trimmers (AIL./ELV.):**

Used to set to reduce the servo travel by flipping each Dual Rate switch. The travel reduction for the aileron and elevator may be set by each trimmer. See page 18 for the aileron/elevator dual rate function operation instructions.

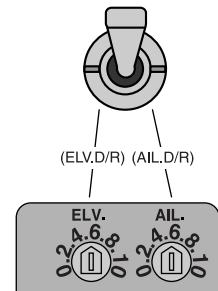

**Throttle ATV Trimer (Low/High)**

Used to adjust throttle servo travel limits.

Servo travel can be adjusted independently in each direction

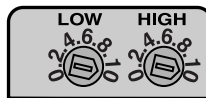

**Trainer switch:** Controls the link between the instructor and student transmitters when using the trainer function. The student transmitter can only be operated when this switch is being activated.

**Transmitter T6YG (Rear Panel/Side Panel)**

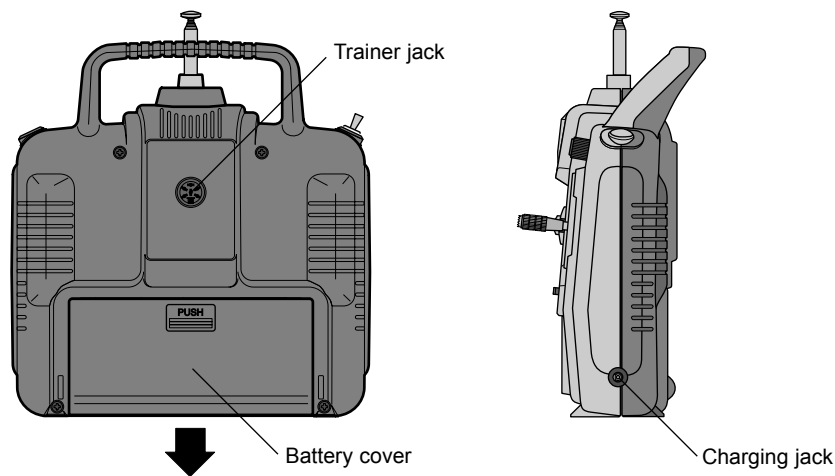

**Trainer jack:** Connects the trainer cord when using the trainer function. The trainer cord is sold separately. See page 19 for the trainer function operation instructions.

**Battery cover:** Use when replacing the battery. Slide the cover downward while pressing the area marked "PUSH".

**Charging jack:** Charging jack used when charging the transmitter nicd battery.

## ⚠ CAUTION

### ⊘ Do not charge Dry Batteries.

Charging dry batteries will cause overheating or breakage and electrolyte leakage and result in burns or damage by the chemical content.

Charging the Nicad Battery

## ⚠ WARNING

### ⊘ Never plug the special slow charger into an AC outlet other than the voltage specified shown on the charger.

If the charger is plugged into an AC outlet other than the specified voltage, overheating, sparking, etc, may cause burns, fire, etc.

### ! Use the special slow charger, or R/C quick charger, sold separately, to charge the R/C nicad batteries.

Overcharging will cause burns, fire, injury, or blindness due to overheating, breakage, electrolyte leakage, etc.

## ⚠ CAUTION

### ! When not using the nicad battery charger, disconnect it from the AC outlet.

The transmitter and receiver nicad batteries can be charged simultaneously or independently.

1. Connect the charger transmitter connector to the transmitter charging jack and the charger receiver connector to the receiver servo nicad battery.
2. Connect the charger to an AC outlet.
3. Check that the charging LED is lit.
4. At the end of charging, disconnect the charger from the AC outlet.

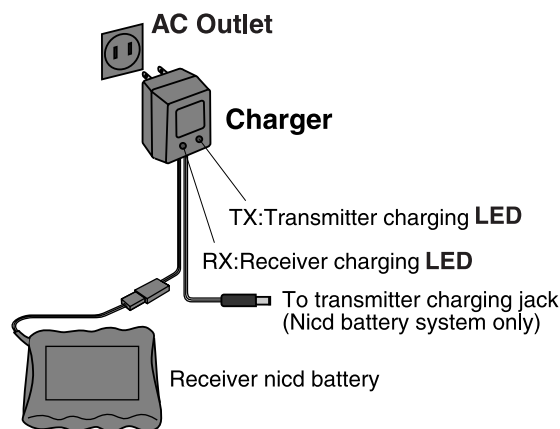

## Receiver R127DF/R147F

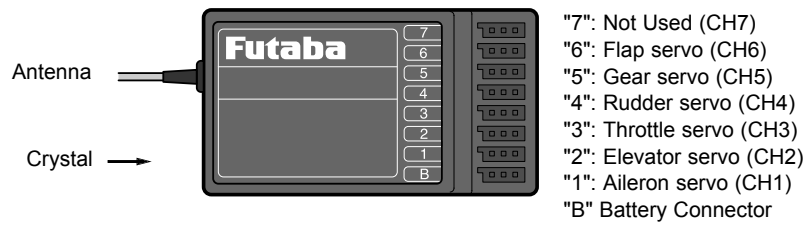

**Crystal:** The crystal is installed at the side of the receiver.

## Servo S3003

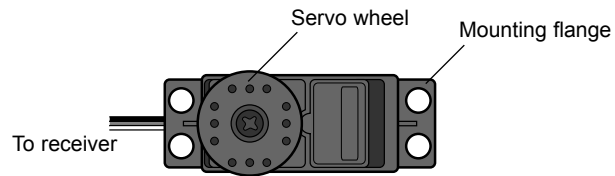

**Accessories:** The following items are supplied with the set:

- Spare servo horns: Use to match the application.
- Servo mounting parts: Rubber grommets, etc.

# Transmitter Operation and Movement of Each Servo

Before making any adjustments, learn the operation of the transmitter and the movement of each servo. (In the following descriptions, the transmitter is assumed to be in the operating state.)

## Aileron Operation

When the aileron stick is moved to the right, the right aileron is raised and the left aileron is lowered, relative to the direction of flight, and the plane turns to the right. When the aileron stick is moved to the left, the ailerons move in the opposite direction. To level the plane, the aileron stick must be moved in the opposite direction. When the aileron stick is moved and held, the plane will roll.

### Right Stick

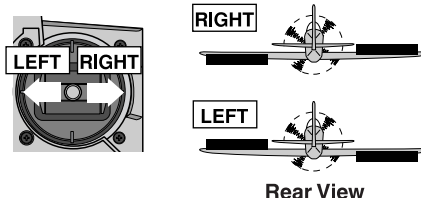

## Elevator Operation

When the elevator stick is pulled back, the tail elevator is raised and the tail of the plane is forced down, the air flow applied to the wings is changed, the lifting force is increased, and the plane climbs (UP operation). When the elevator stick is pushed forward, the elevator is lowered, the tail of the plane is forced up, the air flow applied to the wings is changed, the lifting force is decreased, and the plane dives (DOWN operation).

### Left Stick

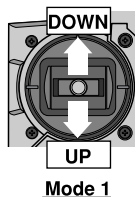

### Right Stick

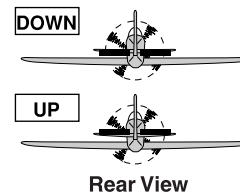
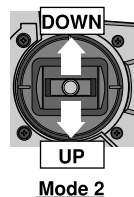

## Throttle Operation

When the throttle stick is pulled back (low throttle), the engine throttle lever arm moves to the SLOW (low speed) side. When the throttle stick is pushed forward (full throttle), the throttle lever arm moves to the HIGH (high speed) side.

### Left Stick

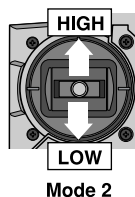

### Right Stick

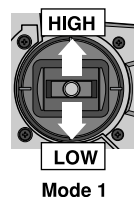

FULL Throttle: carburetor fully opened  
 LOW Throttle: carburetor at idle position (not fully closed)

## Rudder Operation

When the rudder stick is moved to the right, the rudder moves to the right and the nose moves to the right, relative to the direction of flight. When the rudder stick is moved to the left, the rudder moves to the left and the nose moves to the left.

### Left Stick

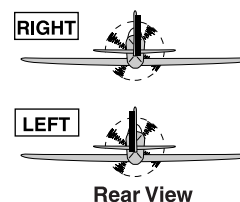
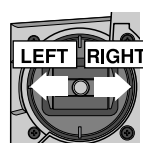

# INSTALLATION AND ADJUSTMENT

This section describes the installation and adjustment of the receiver, servos, etc. to the plane.

## Connections

Connection examples are shown below.

### Connection Example

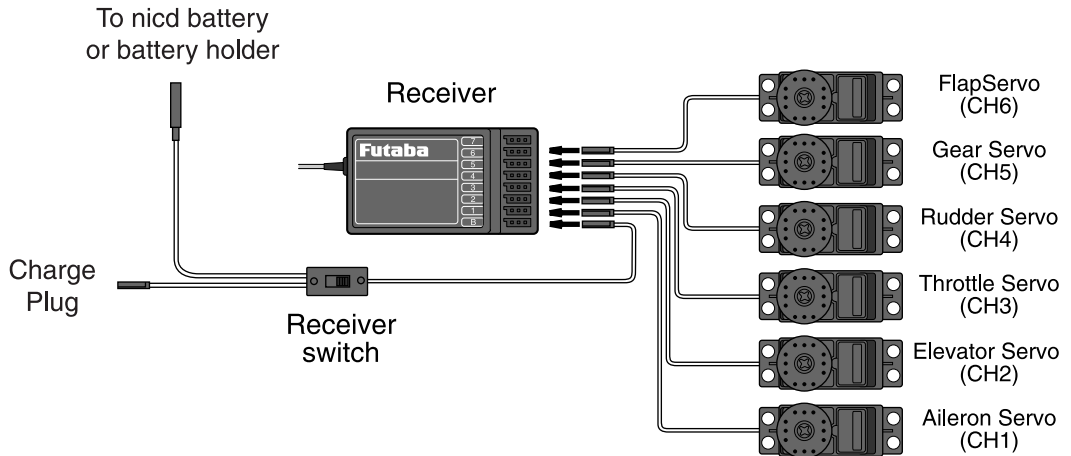

•Four servos are supplied as standard.

## ⚠ WARNING

(Connector Connection)

- ❗ **Insert the receiver, servo, and battery connectors fully and firmly.**

If vibration, etc. causes a connector to work loose during flight, the plane may crash.

(Receiver Vibration proofing / Waterproofing)

- ❗ **Vibration proof the receiver and battery by wrapping them in sponge rubber or some such material. If the receiver may get wet, waterproof them separately by placing them in plastic bags or balloons.**

If the receiver is subjected to strong vibration and shock, or gets wet, it may operate erroneously and cause a crash.

(Receiver Antenna)

- ⊘ **Do not cut or bundle the receiver antenna. Also, do not bundle the antenna together with the servo lead wires.**

Cutting or bundling the receiver antenna will lower the receiver sensitivity and shorten the flight range and cause a crash.

**Antenna installation:** For aircraft, attach the antenna to the top of the tail.

Attach the antenna with a rubber band, etc.

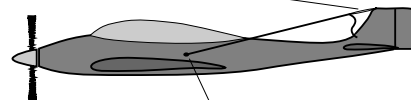

Use a rubber grommet, etc. at the point where the antenna exits the fuselage so that it will not fracture and break.

(Servo Throw)

- ❗ **Operate each servo over its full stroke and adjust the linkages so that the pushrod does not bind or is not too loose.**

Unreasonable force applied to the servo horn will adversely affect the servo and drain the battery quickly.

(Servo Installation)

- ❗ **Install the servos to the servo mount, etc. using a rubber grommet. Also install the servos so that the servo case does not directly touch the servo mount or other parts of the fuselage.**

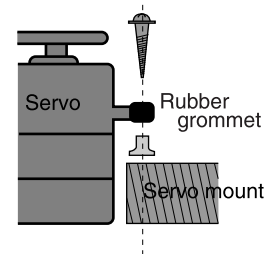

(Servo Horn Screw)

- ❗ **Use the horn screw supplied with the servo.**

If a long screw is used, the interior of the servo may be damaged.

### Power Switch Installation

When installing a receiver power switch to the fuselage, cut a rectangular hole somewhat larger than the full stroke of the switch knob and install the switch so it moves smoothly from ON to OFF.

Always install the switch so it will not come into direct contact with engine oil, dust, etc. Generally, install the switch to the fuselage at the side opposite the muffler exhaust.

# Adjustments

## ⚠ CAUTION

The operating direction, neutral position, and steering angle of each servo are adjustable.

**The basic linkage and adjustments, control layout, and servo, Rx and Nicad installation should conform to the fuselage design drawings and kit instruction manual. Be sure that the center of gravity is at the prescribed position.**

### Adjustment Procedure

Before making any adjustments, set all the SERVO REVERSING switches on the front of the transmitter to the lower(NOR) position and set both Dual Rate trimmers(AIL./ELV.) to the maximum ("10") point. (Set the switches and the trimmers with a small screwdriver, etc.)

Turn on the transmitter and receiver power switches and make the following adjustments:



#### 1. Check the direction of operation of each servo.

If a servo operates in the wrong direction, switch its SERVO REVERSING switch. (The direction of operation can be changed without changing the linkage.) Pay special attention to the direction of the aileron. (See page 14 for a transmitter operation instruction.)

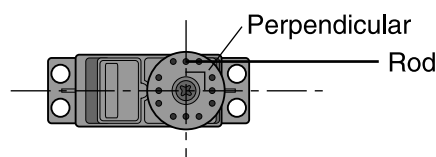

#### 2. Check the aileron, elevator, and rudder neutral adjustment and left-right (up-down) throw.

Check that when the Tx trim levers are in the center, the linkage connection point is perpendicular to the servo. In this position the control surfaces (aileron, elevator, rudder, etc.) must be neutral. If the neutral position of the control surface has changed, reset it by

adjusting the length of the rod with the clevis.

When the throw is unsuitable (different from the deflection angle specified by the kit instruction manual), adjust it by either changing the servo horn, the position of the linkage on the servo horn or the linkage position on the control surface horn.

#### 3. Check the engine throttle (speed adjustment) linkage.

Change the servo horn installation position and hole position so that the throttle is opened fully when the throttle stick is set to HIGH (forward) and is closed fully when the throttle stick and throttle trim are set for maximum slow (backward position and lower position, respectively).

#### 4. After all the linkages have been connected, recheck the operating direction, throw, etc.

Before flight, adjust the aircraft in accordance with the kit and engine instruction manuals.

#### 5. Fly the plane and trim each control for straight and level flight.

# USING OTHER FUNCTIONS

## Aileron/Elevator Dual Rate (D/R) Function

The maximum travel of the aileron and elevator servos can be altered by operating the dual rate switch. For instance, when the switch is in the lower position, the deflection angle is the normal deflection angle. The normal deflection angle, at the low switch position, can be adjusted by the dual rate trimmers (AIL/ELV). The rate can be adjusted from 50% (position 0) to 100% (position 10) of the maximum deflection angle. When the switch is set to the upper position, spins, snap rolls, and other aerobatics that require a maximum deflection angle can be performed.

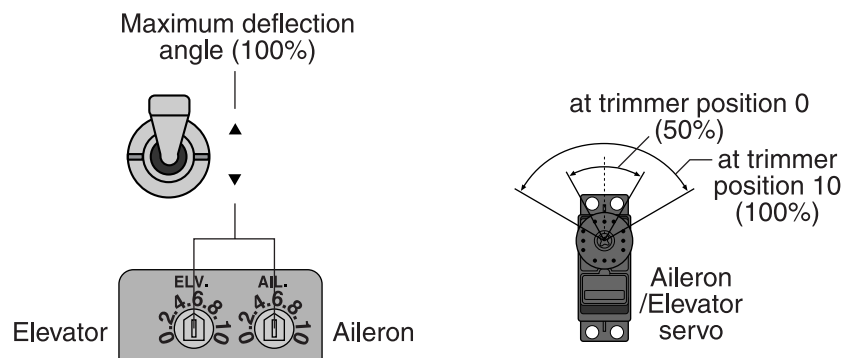

1. Turn on the transmitter and receiver power.
2. Switch the dual rate switch (D/R) to the lower position.
3. Set the stick to the maximum travel in either direction.
4. Using the trimmer, adjust the servo horn to the desired angle.

Adjust each channel (AIL/ELV) by repeating steps 1 through 4.

**\*When not using the dual rate function, set the AIL and ELV trimmers to 100% (fully clockwise).**

## Non-slip Adjustable Lever Head

The length of the stick head can be adjusted.

1. Unlock two heads A and B by turning them in the arrow directions.
2. Adjust the stick to the most comfortable length and lock the heads by turning them in the opposite direction of the arrows.

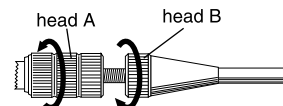

## Stick Lever Spring Tension Adjustment

The operating feel of the aileron, elevator, and rudder sticks can be individually adjusted by adjusting the stick spring tension.

1. Remove the four transmitter rear case screws and carefully remove the rear case.
2. Adjust the spring tension by turning the screw of the channel you want to adjust (clockwise to stiffen counter-clockwise to soften).
3. Close the rear case and tighten the four screws.

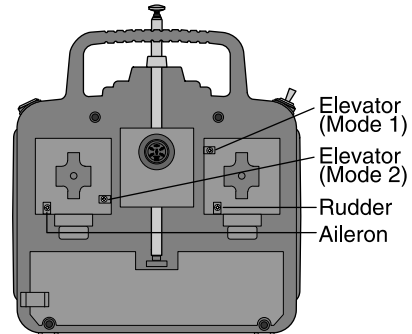

## Trainer Function

The trainer function is a very effective way for training students. To use it, the special trainer cord TC-FM (FUTM4410 USA only - sold separately) is necessary.

The special trainer cord can be connected to SKYSPORT4, SKYSPORT6, 7U series, 8U series, and PCM1024Z series transmitters.

### ⚠ WARNING

- ⊘ **Never turn on the student transmitter power switch.**  
Turning on the power switch will cause interference and a crash.
- ⚠ **Set the student and instructor transmitter functions and trims to the same settings.**  
For example, if the direction of operation is reversed, control will be lost and the plane will crash.
- ⚠ **Both transmitters must have the modulation type that is FM type.**  
If the modulation type is different, control is impossible.

#### Connection

Connect the student and instructor transmitters with the trainer cord.

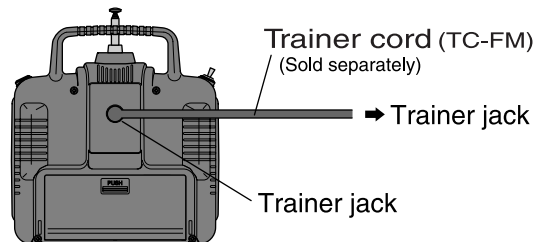

#### Operating Instructions

**Instructor side:** Turn "on" the power switch and extend the antenna to its full length. When the trainer switch is not activated, the instructor has control. When the trainer switch is activated, control is transferred to the student. Release the switch to retain control.

**Student side:** Never turn on the power switch.

# REFERENCE

## Ratings

---

### Transmitter T6YG

(2 sticks, 6 channels, FM transmitter)

Transmitting frequency: 29, 35, 36, 40, 41, 50, 60, 72, or 75 MHz  
Modulation method: FM(Frequency Modulation)  
Power requirement: 12V (penlight battery x8) or 9.6V nicad battery  
Current drain: 180mA

### Servo S3003

(Standard servo)

Power requirement: 4.8V or 6V (common with receiver)  
Current drain: 8mA (idle)  
Output torque: 3.2kg-cm at 4.8V  
Operating speed: 0.23sec/60 degrees at 4.8V  
Size: 40.4x19.8x36mm  
Weight: 37.2g

### Receiver R127DF

(7 channels, FM receiver)

Receiving frequency: 50, 72, or 75 MHz  
Intermediate frequency: 1st IF 10.7MHz 2nd IF 455kHz  
Power requirement: 6V (penlight battery x4), 4.8V or 6v NiCd battery (common with servo)  
Current drain: 10mA  
Size: 64.3 x 35.8 x 21mm  
Weight: 40.5g

### Receiver R147F

(7 channels, FM receiver)

Receiving frequency: 29, 35, 36, 40, 41, 72 MHz  
Intermediate frequency: 455kHz  
Power requirement: 6V (penlight battery x4), 4.8V or 6v NiCd battery (common with servo)  
Current drain: 14mA  
Size: 24.2 x 64 x 17.6mm  
Weight: 26g

**Note:** Specifications and ratings are subject to change without prior notice and may differ from country to country.

# Troubleshooting

If your R/C set does not operate, its range is short, it intermittently stops operating, or it operates erroneously, take the action shown in the table below. If this does not correct the trouble, please contact a Futaba dealer.

Check point	Check item	Action
Transmitter/receiver battery	Dead battery.	Replace the battery. Charge the NiCd battery.
	Incorrect loading.	Reload the batteries in the correct polarity.
	Faulty contact connection.	If the contact spring is deformed, correct it.
	Dirty contacts.	Wipe with a dry cloth.
Transmitter antenna	Loose.	Screw in.
	Not extended to full length.	Extend fully.
Crystal	Disconnected.	Push in.
	Wrong band.	Match transmitter/receiver band.
	Different from specification.	Replace with specified crystal.
Connector connection	Incorrect wiring.	Reinsert.
	Disconnection.	Push in.
Receiver antenna	Close to other wiring.	Separate from other wiring.
	Cut?	Request repair.
	Bundled?	Install in accordance with instruction manual.
Servo linkage	Binding or looseness	Adjust at the fuselage.
Motor (electric motor plane)	Noise countermeasures.	Install a noise absorbing capacitor.

# Glossary

---

The following defines the symbols and terms used in this instruction manual.

### **Aileron (AIL)**

Control surface on the left and right sides of the main wing of an aircraft. It usually controls banking of the aircraft.

### **Channel**

Represents the number of control functions. It can also represent the number of servos that are operated.

### **Down**

Means "down" elevator. It is the direction in which the trailing edge of the elevator moves.

### **Dual Rate (D/R)**

Reduces the servo travel by flipping a switch.

### **Elevator (ELV)**

Control surface that moves up and down on the horizontal stabilizer of an aircraft. It usually controls up and down. (Altitude)

### **Linkage**

Mechanism that connects the servos and the fuselage or wing control surfaces.

### **Modulation Method**

Two modulation methods are used with radio control: AM (Amplitude Modulation) and FM (Frequency Modulation). Radio sets for aircraft mainly use FM. Another method that encodes and transmits the modulated signals is called "PCM".

### **Neutral**

Means the neutral position. It is the state in which a transmitter stick returns to the center when not operated.

### **Normal (NOR)**

For the servo reversing function, it is the normal side. The opposite side is the reverse side.

### **Rudder (RUD)**

Tail control surface that controls the direction of the aircraft.

### **Reverse (REV)**

With the servo reversing function, this refers to the reverse side. The opposite side of reverse is the normal side.

### **Rod**

A wire that connects the servos and the control surfaces.

### **Servo horn**

A part that is installed to the shaft of a servo which changes the rotating motion of the servo to linear motion and transmits the linear motion to a rod. Servo horns come in various shapes.

### **Servo mount**

Base for installing a servo in the aircraft.

### **Stick**

Control for operating the transmitter.

### **Throttle (TH)**

Part that controls the air mixture at the engine intake. When opened (throttle high position), a large air mixture is sucked in and the engine speed increases. When closed (throttle low position), the engine speed decreases.

### **Trim**

A device that fine adjusts the neutral point of each servo for safe flying. It is a mechanism that corrects unbalanced tendencies of the aircraft.

### **Up**

Means "up" elevator. It is the direction in which the trailing edge of the elevator moves.

## Repair Service (for USA)

---

Before requesting repair, read this instruction manual again and recheck your system.  
Should the problem continue, request repair service as follows:

Describe the problem in as much detail as possible and send it with a detailed packing list together with the parts that require service.

- Symptom (Including when the problem occurred)
- System(Transmitter, Receiver, Servos and model numbers)
- Model (Model name)
- Model Numbers and Quantity
- Your Name, Address, and Telephone Number.



1610 Interstate Dr.    Champaign, IL 61822    (217) 398-0007

---

### **FUTABA CORPORATION**

Makuhari Techno Garden Bldg., B6F 1-3 Nakase, Mihama-ku, Chiba 261-8555, Japan  
Phone: (043) 296-5118    Facsimile: (043) 296-5124