

# Futaba®

## DIGITAL PROPORTIONAL RADIO CONTROL

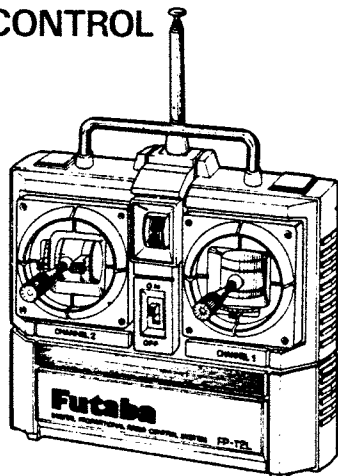

## INSTRUCTION MANUAL

### FP-2L



FUTABA CORPORATION OF AMERICA  
FUTABA CORPORATION

D60304

## FEATURES OF FP-2L

### TRANSMITTER FP-T2L

- New stick mechanism. The left-hand stick changes the neutral position in 5 steps by moving the neutral lever and is extremely easy to use.
- Level meter tells the state of the battery voltage at a glance.
- Can be easily modified for NiCd battery use.
- All channel servo reverse switches, are very convenient whenever reversing is necessary.

### RECEIVER FP-R2GS

- Miniature type, light weight, rugged construction.
- Crystal is replaceable from the outside. (Except "J" Series)
- 3P mini-connectors are compatible with existing sets.

### SERVO FP-S28

- New indirect drive/completely sealed potentiometer substantially improves vibration and shock resistance, and neutral accuracy.
- Unique Futaba power-saving custom IC provides high starting torque narrow dead band, and excellent trackability.
- Fiberglass PBT (polybutylene terephthalate) servo case is mechanically strong and is invulnerable to glow fuel.
- Strong polyacetyl resin precision servo gear featuring smooth operation, accurate neutral, and minimal backlash.
- Fiberglass epoxy PC board with THRU-THE-HOLE plating improves the servo amp vibration and shock resistance.
- Thick film gold plated connector pins eliminate the problem of faulty contact, improve reliability against shock and vibration.
- Special pad grommets simplify mounting of the servo, and are extremely vibration-resistant.
- Four kind of special adjustable horn are available.
- High 48.7oz-in (3.5 kg-cm) output torque is perfect for almost all models.

Thank you for buying a Futaba digital proportional radio control set. Please read this manual carefully before using your new set.



## FUTABA CORPORATION OF AMERICA

555 West Victoria Street, Compton, Calif. 90220, U.S.A.  
Phone: 213-537-9610 Telex: 23-0691227 Facsimile: 213-637-8529

## FUTABA CORPORATION

Tokyo Office: Daido Bldg. 3-1-16, Sotokanda, Chiyoda-ku, Tokyo, Japan.  
Phone: (03) 255-5881 Telex: J26532

Printed in Japan 840520 CC

## SET CONTENTS AND RATINGS

(Specifications are subject to change without prior notice.)

	FP-2L
Transmitter	FP-T2L
Receiver	FP-R2GS
Servo	FP-S28x2
	Switch, battery holder, etc.

### TRANSMITTER FP-T2L

Operating system: 2 stick (neutral free setting)  
Transmitting frequency: 27MHz band  
Modulation system: AM (amplitude modulation)  
Power requirement: 10.5V, AA penlight battery x 7  
Current drain: 100mA

### RECEIVER FP-R2GS

Receiving frequency: 27MHz band  
Intermediate frequency: 455kHz  
Selectivity: 3kHz/-3dB  
Range: 500m on the ground, 1000m in the air with FP-T2L  
Power requirement: 4.0 ~ 6.6V, flashlight battery x 4, shared with servo  
Current drain: 6V 10mA  
Dimensions: 37 x 53.5 x 19mm  
Weight: 38g

### SERVO FP-S28

Control system: +pulse width control  
Operating angle: Rotary system one-side 45° or greater (including trim)  
Power requirement: 4.8 or 6.0V (shared with receiver)  
Current drain: 6.0V, 8mA (at : dle)  
Output torque: 48.7oz-in (3.5kg-cm)  
Operating Speed: 0.24 sec/60°  
Dimensions: 1.59 x 0.79 x 1.59 inch (40.5 x 20 x 40.5mm)  
Weight: 1.87oz (53g)

\* Subject to change without notice.

## HANDLING THE TRANSMITTER FP-T2L

- The below figures show the names of each part of the transmitter. Memorize the names and functions before using your set.
- Remove the battery cover on the rear of the set and load the 7 penlight batteries as shown in the figure, being sure that the polarities are correct.
- Extend the antenna fully and set the power switch to ON. The pointer of the level meter should deflect to the green zone. If it does not deflect, or deflects very little, check the batteries and their connections and polarity.
- If the level meter pointer deflects to the red zone, the receiving range will be short. Therefore, replace the batteries whenever the pointer drops to the boundary between the red and green zones.
- The trim lever fine adjusts the rudder. Use it for neutral adjustment and to correct the flying posture after mounting of the mechanism. After test flight, keep the trim lever in the neutral position as much as possible and adjust pushrod linkage for correction.
- The neutral position of the left-hand elevator stick (engine control stick) can be selected in 5 steps by shifting the neutral lever as shown in the figure. Adjust it to match the particular applications.
- Replace the crystal by removing the crystal holder at the rear of the transmitter. AM, crystal, transmitter (T), receiver (R).
- The elevator stick is a self-neutral type. To change it to a ratchet type, remove the sliding plate as illustrated in the figure, then remove the spring and swing arm.

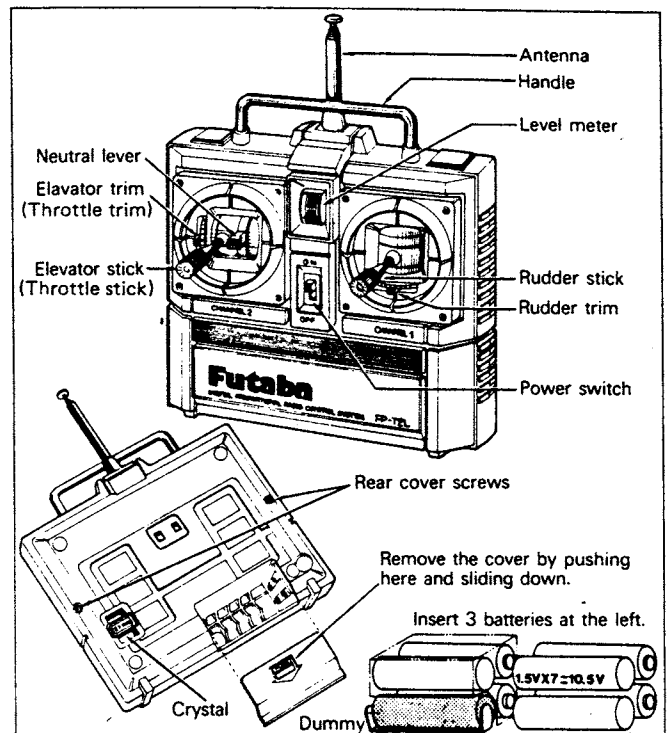

### Modification from self-neutral to ratchet

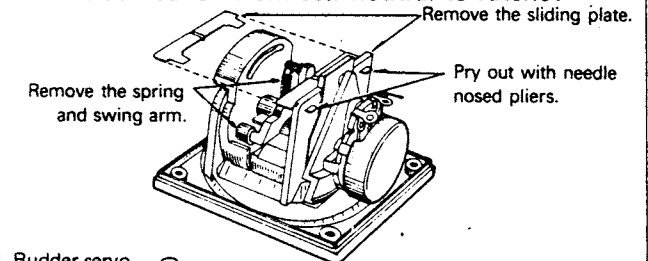

## HANDLING THE FP-R2GS RECEIVER AND FP-S28 SERVO

- Load the four penlight batteries into the battery holder in the correct polarity, and tighten the cover coin screw.
- Connect the servo and switch securely as illustrated in the figure. Then extend the transmitter and receiver antenna fully.
- Set the transmitter power switch to ON; then set the receiver switch to ON. The servo stops near the neutral position. Operate the transmitter sticks and check that the servos faithfully follow movement of the sticks.
- Set the pushrod at each servo horn and check that the direction of operation of each rudder coincides with that of the transmitter controls.
- Operate each servo horn over its operating range, being sure that the pushrods do not bind or bend. Applying unreasonable force to the servo horn will adversely affect the servo and quickly drain the batteries. Be sure the operating range of the rudder is larger than the fully stroke (including the trim component) of the servo travel. Mount servos so that the servo horns of each servo move smoothly and do not interfere with each other even when the trim lever and stick lever are operated in the same direction simultaneously.
- Pay careful attention to noise. Intermittent contact of metal parts due to engine vibration, etc. will generate noise and cause the receiver servos to operate erroneously. We recommend the use of noiseless parts.
- When installing the switch harness, drill a rectangular hole somewhat larger than the full stroke of the switch knob and mount the switch so that it can be turned ON and OFF smoothly and positively. This also applies when the switch is mounted in the fuselage and turned ON and OFF

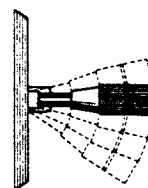
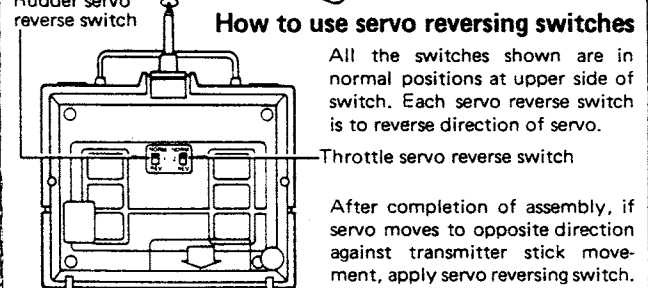

### Neutral lever operation

The neutral position of the stick lever can be adjusted in 5 steps as illustrated in the figure by moving the neutral lever.

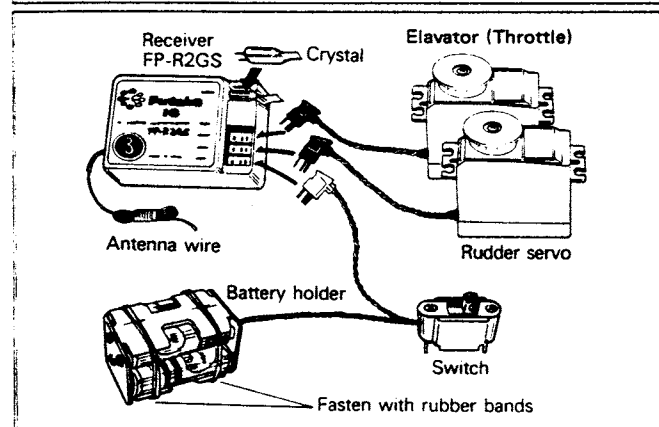

from the outside with wire, etc. Mount the switch where it will not come into direct contact with engine oil, dust, etc.

- Never cut the receiver antenna; even though it may seem too long.
- When using the receiver and servos in a boat or automobile, waterproof and dustproof the radio compartment. After use, open the radio compartment to prevent condensation.

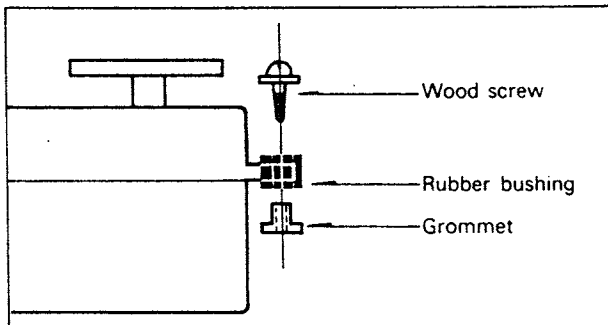

- After mounting and checking each part, range check the system by extending the transmitter to its shortest length and the receiver antenna to its full length. The model should operate at a distance of 20 ~ 30m. The rudders (servos) should faithfully follow the operations performed at the transmitter.
- The crystal can be changed from outside the receiver case. Always use Futaba pair crystals.
- Install the servos securely. Use servo trays for easy and convenient installation of servo. When installing the servo directly to wood, use an eyelet and flat washers as illustrated in the figure.

- A spare horn is supplied with the set. Use it as needed.
- Pack the receiver in sponge rubber and wrap the rubber with rubber bands.

Mount the receiver at the center where it will not be affected by engine vibrations and will not directly touch the fuselage.

- If the receiver is to be used near water, such as in a boat or seaplane, waterproof it by placing it in a plastic bag and sealing the mouth of the bag with rubber bands. After use, immediately remove the receiver from the bag to prevent condensation.
- Also pack the receiver and servo batteries in sponge rubber and wrap the sponge with rubber bands. When used in an airplane, shifting of the batteries will change the center of gravity of the plane. After positioning the batteries, fasten them securely. Waterproof the connectors in the same manner as the receiver.
- Fasten the servo and switch leads with the same rubber bands used to wrap the receiver.
- Futaba three-wire servos can be used with any Futaba transmitter and receiver combination. (Except "J" series)
- After mounting and checking all the parts, take your set to your hobby dealers, or an experienced radio control enthusiast, and ask them to inspect it and explain the handling and precautions for radio control models.
- To enjoy your radio control model to the fullest, always follow the instructions of an experienced radio control enthusiast and strictly obey all safety regulations.

## MODIFICATION TO NICKEL-CADMIUM BATTERY

- Using the Futaba FBPK-4 (L Series NiCd battery charger set), modify the transmitter power supply as shown in the figure.
- A nickel-cadmium battery (NR4C) can be used as the receiver and servo power supply without any modification.
- Be sure the polarity is correct when soldering this wire to the switch.

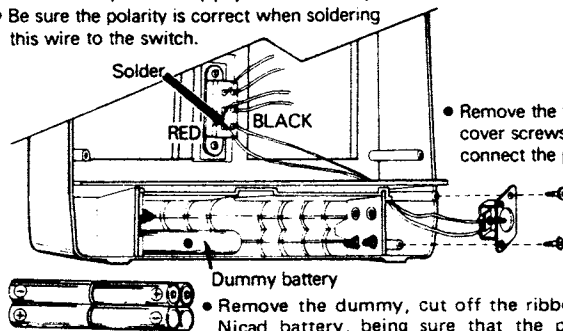

- Remove the transmitter rear cover screws and install and connect the prewired jack.

- Remove the dummy, cut off the ribbon, and insert the Nicad battery, being sure that the polarity is correct.

### Handling the nickel-cadmium battery

Since the battery contact may be faulty when the battery cannot be charged, or discharges quickly, remove the battery from the battery holder and wipe the (+) and (-) contact surfaces shown in the figure with a dry cloth (do not use an organic solvent, etc.). To prevent malfunctions due to faulty battery contact, it is suggested that the battery be removed and cleaned about once every 1 to 2 months.

(Note) Because the battery contact surfaces are made of nickel plated iron, do not clean them with a file, sandpaper, etc.; otherwise the surfaces may rust.

- Remove the transmitter rear cover blind plate and install the cover with the screws.
- Normally, charge the battery for about 15 hours. If the battery has not been used for a long time, charge it for 20 hours.

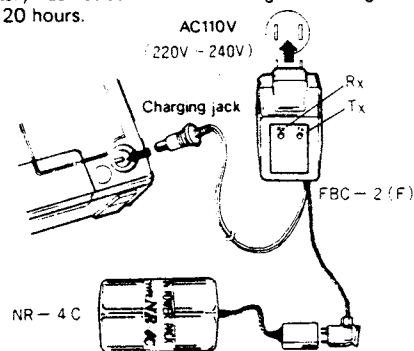

## GUARANTEE

Your NEW FUTABA Digital Proportional R/C system is guaranteed against defects in workmanship and material for 180 days from the date of purchase when the attached registration card is returned to us within ten days of purchase.

This Guarantee is null and void if the R/C system has been improperly handled, damaged in a crash, or tampered with and does not cover the replacement of plastic housings or electronic components damaged due to the use of improper voltages.

When service is required, please take your equipment to your local authorized service station or ship it directly to us. All postage, shipping, and insurance charges must be paid by the user.

# Futaba Digital Proportional Frequencies (FOR U.S.A.)

Frequency	Channel No.	Flag Color	75MHz - Car & Boat only	53MHz - Aircraft/Car/Boat - FCC Amateur License Required
26.995	-	Brown	75.430	62
27.045	-	Red	75.470	64
27.095	-	Orange	75.510	66
27.145	-	Yellow	75.550	68
27.195	-	Green	75.590	70
27.255	-	Blue	75.670	74
72.030	12	Brown-Red (Top Flag/Ribbon-Bottom Flag/Ribbon)	75.710	76
72.080	-	White/Brown	75.750	78
72.160*	-	White/Blue	75.790	80
72.240	-	White/Red	75.830	82
72.320*	-	White/Purple	75.870	84
72.400	-	White/Orange	53.100	-
72.450	38	Orange-Grey	53.200	-
72.590	40	Yellow-Black	53.300	-
72.630	42	Yellow-Red	53.400	-
72.670	44	Yellow-Yellow	53.500	-
72.710	46	Yellow-Blue	53.600	-
72.750	48	Yellow-Grey	53.700	-
72.790	50	Green-Black	53.800	-
72.830	52	Green-Red		
72.870	54	Green-Yellow		
72.910	56	Green-Blue		
72.960*	-	White/Yellow		
75.640	-	White/Green		

FOR OTHER MARKETS, FOLLOWING FREQUENCIES ARE AVAILABLE.

	FP-2L	
	AM	FM
27MHz Band	○	X
29MHz Band	○	X
35MHz Band	○	X
40MHz Band	○	X
53/60MHz Band	X	X
72/75MHz Band	○	X

The authorized frequencies on each countries are as follows:

England . . . . . 27 & 35MHz AM and FM  
 Sweden . . . . . 27 & 35MHz AM and FM  
 Scandinavian countries . . . . . 27, 35 and 40MHz AM/FM  
 Australia . . . . . 29MHz  
 U.S.A. . . . . 27 & 72MHz (amonly)

- The frequency of Futaba digital proportional sets can be changed among bands (1) ~ (6) on the 27MHz band only.
- However, a 27MHz band set cannot be changed to 72MHz band, and vice versa.
- Therefore, always attach the correct frequency flag to the end of the transmitter antenna. Each frequency band has its own designated color, as stated in the left. The

frequency flag is intended for identification purposes.

- Also change the frequency flag when frequency is changed.
- Futaba paired crystals are precisely matched. Always use a Futaba crystal set (transmitter, receiver) when changing the frequency.
- It is illegal to change crystals of transmitter on the 72-75MHz bands in the U.S.A.

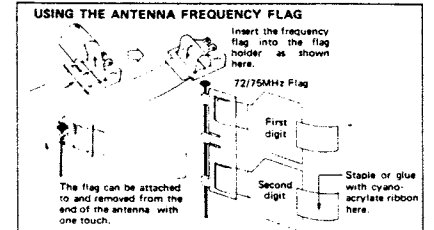

## Splined Horn

This horn permits shifting of the servo neutral position at the servo horn. Setting and shifting the neutral position

### a) Angle divisions

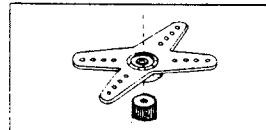

- 1) The splined horn has 25 segments. The amount of change per segment is:  $360 \div 25 = 14.4^\circ$
- 2) The minimum adjustable angle is determined by the number of arms or number of the holes. For four arms, the minimum adjustable angle is:

$$360^\circ \div \frac{(24 \times 4)}{\text{Number of divisions}} = 3.6^\circ$$

### b) Effect

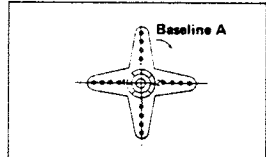

To shift the holes center line to the right (clockwise) relative to baseline A, shift arm 2 to the position of arm 1 and set it to the position closest to baseline A.

(Example) For a four arm horn, the angular shift per segment is  $14.4^\circ$ . The shift to the right is  $90^\circ - (14.4 \times 6) = 3.6^\circ$

To shift by the same angle in the opposite direction, use the opposite arm number.

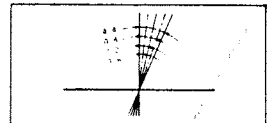

For a six arm horn, turn the arm counterclockwise and set arm 2 to the position of arm 1. The adjustable angle is  $60^\circ - (14.4 \times 4) = 2.4^\circ$ .

Arm 3 shift  $4.8^\circ$  to the right, arm 6 shifts  $2.4^\circ$  to the left, and arm 4 shifts  $7.2^\circ$  to the right and left.

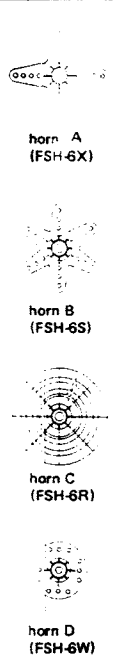
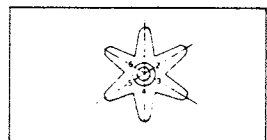

## FP-S28

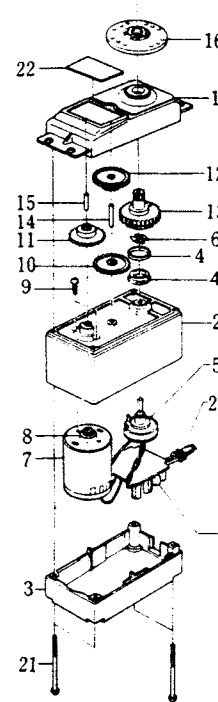

No.	Part Name	Part No.
1	Upper case	
2	Middle case	FCS-28
3	Bottom case	
4	Metal bearing	S04134
5	Potentiometer	J39995
6	VR drive plate	S02753
7	Motor	S91212
8	Motor pinion	S02461
9	Motor mounting screw 2x3	J50002
10	1st gear	FGS-28
11	2nd rear	FGS-28
12	3rd gear	FGS-28
13	Final gear	FGS-28
14	Intermediate shaft	S02495
15	2nd shaft	S02494
16	Servo horn D	FSH-6W
17	Horn mounting screw 2.6x8	FSH-41
18	Printed wiring board	AS1202
19	S28, with 3PC cord	FPC-3M
20	Lead wire packing	S90045
21	Case mounting screw	J50400
22	Nameplate	S80700

## REPAIR SERVICE

- When requesting repair of trouble that has occurred suddenly or from long use, describe the trouble symptoms in as much detail as possible. This will facilitate detection of the trouble point and shorten the repair period greatly.

- Defects caused by faulty materials or workmanship will be corrected free of charge.

- This limited warranty is null and void if the set has been tampered with or disassembled. Refer to warranty statement for details.

## WORLD SALES & SERVICE FACILITIES:

Australia: FUTABA SALES AUSTRALIA PTY. LTD., MELBOURNE TEL: 211-4788  
 Argentina: MODELISMO AERONAUTICO DEGA SRL, BUENOS AIRES TEL: 393-2299  
 Canada: UDISCO LTD, MONTREAL TEL: 481-8109  
 Chile: HOBBY LANDIA, SANTIAGO TEL: 743957  
 Denmark: FUTABA IMPORT DENMARK, COPENHAGEN TEL: 02-91 01 01  
 England: RIPMAX LIMITED, LONDON TEL: 01-8048272  
 Finland: NORES OY, HELSINKI TEL: 90-520311  
 Greece: C. & G. MACRIYIANNIS CO., PIRAEUS TEL: 02-14178191  
 Hong Kong: RADAR CO. LTD. TEL: 3-680507  
 Italy: R.C.S. RADIO CONTROL SYSTEM, CREMONA TEL: 0372-20588

Lebanon: KHAIRALLAH MODEL CRAFT, BEIRUT TEL: 326-681  
 New Zealand: AMALGAMATED WIRELESS (AUSTRALIA) N.Z. LTD., WELLINGTON TEL: 58-979  
 Norway: MODEL HOBBY A/S, OSLO TEL: 442015  
 Singapore: SINGAPORE HOBBY SUPPLIES TEL: 430337  
 South Africa: REDIPAK (PTY.) LTD., JOHANNESBURG TEL: 21 1511  
 Spain: HOBBY & TOY INTERNATIONAL, LAS PALMAS TEL: 21-6930  
 Sweden: RADIO CONTROL CENTER, JONKOPING TEL: 336-145360  
 U.S.A.: FUTABA CORPORATION OF AMERICA, CALIFORNIA TEL: 213-537-9610  
 W. Germany: ROBBE MODELLSPORT GMBH, GREBENHAIN TEL: 06644-7041