

# BLADE<sup>TM</sup> 400 3D



**E-flite**<sup>®</sup>  
ADVANCING ELECTRIC FLIGHT

---

## Specifications

---

Main Rotor Diameter.....	28.2 in (718mm)
Tail Rotor Diameter.....	5.3 in (135mm)
Height .....	9.0 in (230mm)
Length.....	25.6 in (650mm)
Weight with Battery.....	23.5 oz (665 g)
Motor .....	420H brushless outrunner, 3800Kv (installed)
ESC .....	25-amp brushless (installed)
Battery .....	3S 11.1V 1800mAh 20C Li-Po (included)
Charger .....	DC Li-Po Balancing Charger (included)
Transmitter.....	Spektrum DX6i 2.4GHz DSM2 6-channel Computer Radio (included)
Receiver .....	Spektrum AR6100e 2.4GHz DSM2 Microlite Receiver (installed)
Servos.....	DS75H Digital Sub-Micro (4 installed)
Gyro.....	G110 Micro Heading Lock (installed)

## Table of Contents

Specifications .....	1
Introduction .....	3
Warning .....	3
Note on Lithium Polymer Batteries .....	3
Warranty Period .....	3
Limited Warranty .....	4
Damage Limits .....	4
Safety Precautions .....	4
Questions, Assistance and Repairs .....	4
Inspections or Repairs .....	5
Warranty Inspection and Repairs .....	5
Non-Warranty Repairs .....	5
Additional Safety Precautions and Warnings .....	6
Additional Required Equipment .....	6
Blade 400 3D Contents .....	7
Preparing for the First Flight Checklist .....	8
Flying Checklist .....	8
Battery Warnings and Guidelines .....	9
Battery Charging .....	11
Charge Errors and Indications .....	14
Installing the Transmitter Batteries .....	15
Installing the Flight Battery .....	16
Control Test .....	17
Electronic Speed Control (ESC) Features, Arming and Motor Control Test .....	20
Gyro Initialization, Response Test and Adjustment .....	23
Understanding the Primary Flight Controls .....	27
Normal and Stunt Flight Modes .....	30
Throttle Hold .....	32
Before the First Flight .....	34
Choosing a Flying Area .....	35
Flying the Blade 400 3D .....	35
Main Rotor Blade Tracking Adjustment .....	37
Flybar Paddle Tracking Adjustment .....	39
Head Dampening Shims and Tuning Cyclic Response .....	40
Recommended Maintenance .....	40
2007 Official AMA National Model Aircraft Safety Code .....	41
Exploded View Parts Listing .....	42
Exploded View .....	43
Replacement Parts List .....	44
Optional Parts List .....	44
NOTES .....	45
NOTES .....	46
NOTES .....	47

## Introduction

The Blade™ 400 3D RTF is designed to offer intermediate to advanced heli pilots a ready-to-fly experience like no other. It comes 100% factory built and tested so you can get flying right away, and is equipped with state-of-the-art features like brushless and Li-Po power, a heading lock gyro, digital servos and CCPM control. From smooth hovering to 3D flying, the Blade 400 3D's size and performance allow it to be flown outdoors in breezier conditions that would typically ground smaller micro-class helicopters.

In addition to its impressive features and performance, the Blade 400 3D is the first ready-to-fly mini-heli to come equipped with Spektrum's advanced DX6i 2.4GHz DSM2™ 6-channel programmable computer transmitter. Besides providing freedom from frequency restrictions and interference, the DX6i's DSM2 technology offers other unique advantages like faster control response and innovative features such as ServoSync™. ServoSync automatically resequences transmitted data so mixed servos receive their pulses at the same time so you can fly extreme 3D aerobatics with absolute precision. The system also includes the feather light, 4.4-gram Spektrum™ AR6100e Microlite Receiver.

Other DX6i features include:

- Full-range capability
- 10-model memory
- Heli and airplane programming
- Standard or 120° CCPM swashplate mixing
- 3-axis dual rates and exponential
- Travel adjust
- Sub trim
- Servo monitor
- Two 5-point throttle curves
- Three 5-point pitch curves
- Revo mixing
- Gyro sensitivity programming
- Two programmable mixes

The DX6i is not only perfectly suited for the Blade 400—it can also be used to fly just about any size and type of model due to its full-range and programming capabilities.

And although the Blade 400 3D is nearly ready-to-fly right from the box, please take the time to read through this manual for tips on battery safety and charging, control checks, adjustments and more before making your first flight.

## Warning

An RC helicopter is not a toy! If misused, it can cause serious bodily harm and damage to property. Fly only in open areas, preferably at AMA (Academy of Model Aeronautics) approved flying sites, following all instructions.

Keep loose items that can get entangled in the rotor blades away from the main and tail blades, including loose clothing, or other objects such as pencils and screwdrivers. Especially keep your hands away from the rotor blades.

## Note on Lithium Polymer Batteries



Lithium Polymer batteries are significantly more volatile than alkaline or Ni-Cd/Ni-MH batteries used in RC applications. All manufacturer's instructions and warnings must be followed closely. Mishandling of Li-Po batteries can result in fire. Always follow the manufacturer's instructions when disposing of Lithium Polymer batteries.

## Warranty Period

Horizon Hobby, Inc., (Horizon) warrants that the Products purchased (the "Product") will be free from defects in materials and workmanship at the date of purchase by the Purchaser.

---

### Limited Warranty

---

(a) This warranty is limited to the original Purchaser ("Purchaser") and is not transferable. REPAIR OR REPLACEMENT AS PROVIDED UNDER THIS WARRANTY IS THE EXCLUSIVE REMEDY OF THE PURCHASER. This warranty covers only those Products purchased from an authorized Horizon dealer. Third party transactions are not covered by this warranty. Proof of purchase is required for warranty claims. Further, Horizon reserves the right to change or modify this warranty without notice and disclaims all other warranties, express or implied.

(b) Limitations- HORIZON MAKES NO WARRANTY OR REPRESENTATION, EXPRESS OR IMPLIED, ABOUT NON-INFRINGEMENT, MERCHANTABILITY OR FITNESS FOR A PARTICULAR PURPOSE OF THE PRODUCT. THE PURCHASER ACKNOWLEDGES THAT THEY ALONE HAVE DETERMINED THAT THE PRODUCT WILL SUITABLY MEET THE REQUIREMENTS OF THE PURCHASER'S INTENDED USE.

(c) Purchaser Remedy- Horizon's sole obligation hereunder shall be that Horizon will, at its option, (i) repair or (ii) replace, any Product determined by Horizon to be defective. In the event of a defect, these are the Purchaser's exclusive remedies. Horizon reserves the right to inspect any and all equipment involved in a warranty claim. Repair or replacement decisions are at the sole discretion of Horizon. This warranty does not cover cosmetic damage or damage due to acts of God, accident, misuse, abuse, negligence, commercial use, or modification of or to any part of the Product. This warranty does not cover damage due to improper installation, operation, maintenance, or attempted repair by anyone other than Horizon. Return of any goods by Purchaser must be approved by Horizon before shipment.

---

### Damage Limits

---

HORIZON SHALL NOT BE LIABLE FOR SPECIAL, INDIRECT OR CONSEQUENTIAL DAMAGES, LOSS OF PROFITS OR PRODUCTION OR COMMERCIAL LOSS IN ANY WAY CONNECTED WITH THE PRODUCT, WHETHER SUCH CLAIM IS BASED IN CONTRACT, WARRANTY, NEGLIGENCE, OR STRICT LIABILITY. Further, in no event shall the liability of Horizon exceed the individual price of the Product on which liability is asserted. As Horizon has no control over use, setup, final assembly, modification or misuse, no liability shall be assumed nor accepted for any resulting damage or injury. By the act of use, setup or assembly, the user accepts all resulting liability.

If you as the Purchaser or user are not prepared to accept the liability associated with the use of this Product, you are advised to return this Product immediately in new and unused condition to the place of purchase.

Law: These Terms are governed by Illinois law (without regard to conflict of law principals).

---

### Safety Precautions

---

This is a sophisticated hobby Product and not a toy. It must be operated with caution and common sense and requires some basic mechanical ability. Failure to operate this Product in a safe and responsible manner could result in injury or damage to the Product or other property. This Product is not intended for use by children without direct adult supervision. The Product manual contains instructions for safety, operation and maintenance. It is essential to read and follow all the instructions and warnings in the manual, prior to assembly, setup or use, in order to operate correctly and avoid damage or injury.

---

### Questions, Assistance and Repairs

---

Your local hobby store and/or place of purchase cannot provide warranty support or repair. Once assembly, setup or use of the Product has been started, you must contact Horizon directly. This will enable Horizon to better answer your questions and service you in the event that you may need any assistance. For questions or assistance, please direct your email to [productsupport@horizonhobby.com](mailto:productsupport@horizonhobby.com), or call 877.504.0233 toll free to speak to a service technician.

---

### Inspections or Repairs

---

If this Product needs to be inspected or repaired, please call for a Return Merchandise Authorization (RMA). Pack the Product securely using a shipping carton. Please note that original boxes may be included, but are not designed to withstand the rigors of shipping without additional protection. Ship via a carrier that provides tracking and insurance for lost or damaged parcels, as Horizon is not responsible for merchandise until it arrives and is accepted at our facility. A Service Repair Request is available at [www.horizonhobby.com](http://www.horizonhobby.com) on the "Support" tab. If you do not have internet access, please include a letter with your complete name, street address, email address and phone number where you can be reached during business days, your RMA number, a list of the included items, method of payment for any non-warranty expenses and a brief summary of the problem. Your original sales receipt must also be included for warranty consideration. Be sure your name, address, and RMA number are clearly written on the outside of the shipping carton.

---

### Warranty Inspection and Repairs

---

To receive warranty service, you must include your original sales receipt verifying the proof-of-purchase date. Provided warranty conditions have been met, your Product will be repaired or replaced free of charge. Repair or replacement decisions are at the sole discretion of Horizon Hobby.

---

### Non-Warranty Repairs

---

Should your repair not be covered by warranty the repair will be completed and payment will be required without notification or estimate of the expense unless the expense exceeds 50% of the retail purchase cost. By submitting the item for repair you are agreeing to payment of the repair without notification. Repair estimates are available upon request. You must include this request with your repair. Non-warranty repair estimates will be billed a minimum of 1/2 hour of labor. In addition you will be billed for return freight. Please advise us of your preferred method of payment. Horizon accepts money orders and cashiers checks, as well as Visa, MasterCard, American Express, and Discover cards. If you choose to pay by credit card, please include your credit card number and expiration date. Any repair left unpaid or unclaimed after 90 days will be considered abandoned and will be disposed of accordingly. Please note: non-warranty repair is only available on electronics and model engines.

Electronics and engines requiring inspection or repair should be shipped to the following address:

Horizon Service Center  
4105 Fieldstone Road  
Champaign, Illinois 61822

All other Products requiring warranty inspection or repair should be shipped to the following address:

Horizon Product Support  
4105 Fieldstone Road  
Champaign, Illinois 61822

Please call 877-504-0233 with any questions or concerns regarding this Product or warranty.

---

### Additional Safety Precautions and Warnings

---

As the user of this product, you are solely responsible for operating it in a manner that does not endanger yourself and others or result in damage to the product or the property of others.

This model is controlled by a radio signal that is subject to interference from many sources outside your control. This interference can cause momentary loss of control so it is advisable to always keep a safe distance in all directions around your model, as this margin will help to avoid collisions or injury.

- Never operate your model with low transmitter batteries.
- Always operate your model in an open area away from cars, traffic, or people.
- Avoid operating your model in the street where injury or damage can occur.
- Never operate the model out into the street or populated areas for any reason.
- Carefully follow the directions and warnings for this and any optional support equipment (chargers, rechargeable battery packs, etc.) that you use.
- Keep all chemicals, small parts and anything electrical out of the reach of children
- Moisture causes damage to electronics. Avoid water exposure to all equipment not specifically designed and protected for this purpose.
- Never lick or place any portion of your model in your mouth as it could cause serious injury or even death.

---

### Additional Required Equipment

---

No additional equipment is required to complete your Blade 400 3D.

---

### Blade 400 3D Contents

---

Item	Description
Not Available Separately	Blade 400 3D RTF Airframe
SPM6600	Spektrum DX6i 2.4GHz DSM2 6-channel computer radio
EFLB18003S	3S 11.1V 1800mAh 20C Li-Po, 13GA EC3
EFLC3115	3S 11.1V Li-Po Balancing Charger, 1.8A
EFLH1001	Mini Helicopter Main Blade Holder
EFLH1474	Mounting Accessories, Screwdriver & Wrench Set
Not Available Separately	Hook and Loop Material
Not Available Separately	4 AA Batteries



## Preparing for the First Flight Checklist

Please note this checklist is not intended to be a replacement for the content included in this instruction manual. Although it can be used as a quick start guide, we strongly suggest reading through this manual completely before proceeding.

- Remove and inspect contents
- Begin charging the flight battery
- Install the 4 included AA batteries in the transmitter
- Install the flight battery in the helicopter (once it has been fully charged)
- Test the controls
- Familiarize yourself with the controls
- Find a suitable area for flying

## Flying Checklist

Please note this checklist is not intended to be a replacement for the content included in this instruction manual. Although it can be used as a quick start guide, we strongly suggest reading through this manual completely before proceeding.

- Always turn the transmitter on first
- Plug the flight battery into the electronic speed control (ESC)
- Allow the ESC and gyro to arm and initialize properly
- Fly the model
- Land the model
- Unplug the flight battery from the ESC
- Always turn the transmitter off last

## Battery Warnings and Guidelines

While the 3S 11.1V 1800mAh Lithium Polymer Battery (EFLB18003S) included with your Blade 400 3D features Charge Protection Circuitry and Balance Charging via the included 3S 11.1V 1.8-Amp Lithium Polymer Balancing Charger (EFLC3115) to help ensure a safe charge every time, you **MUST** read the following safety instructions and warnings before handling, charging or using the Li-Po battery.



**Note:** Lithium Polymer batteries are significantly more volatile than the alkaline, Ni-Cd or Ni-MH batteries used in RC applications. All instructions and warnings must be followed exactly. Mishandling of Li-Po batteries can result in fire.

By handling, charging or using the included Li-Po battery you assume all risks associated with lithium batteries. If you do not agree with these conditions, return your complete Blade 400 3D model in new, unused condition to the place of purchase immediately.

- You must charge the included 3S 11.1V 1800mAh Li-Po battery in a safe area away from flammable materials.
- Do not charge the battery when installed in the helicopter.
- Never charge the battery unattended. When charging the battery you should always remain in constant observation to monitor the charging process and react to potential problems that may occur.
- After flight, the battery must be cooled to ambient temperature before charging.
- **You MUST use the included 3S 11.1V 1.8-Amp Li-Po Balancing Charger ONLY. Failure to do so may result in a fire causing personal injury and/or property damage. DO NOT use a Ni-Cd or Ni-MH charger.**



- If at any time during the charge or discharge process the battery begins to balloon or swell, discontinue charging or discharging immediately. Quickly and safely disconnect the battery, then place it in a safe, open area away from flammable materials to observe it for at least 15 minutes. Continuing to charge or discharge a battery that has begun to balloon or swell can result in a fire. A battery that has ballooned or swollen even a small amount must be removed from service completely.

- In the event of a crash, you must quickly and safely disconnect and remove the battery from the model, then place it in a safe, open area away from flammable materials to observe it for at least 15 minutes.
- Store the battery at room temperature and approximately ½ charge (3.8V per cell; 11.4V for a 3S battery pack) for best results.
- When transporting or temporarily storing the battery, the temperature range should be from 40–120 degrees Fahrenheit. Do not store the battery or model in a car or direct sunlight whenever possible. If stored in a hot car, the battery can be damaged or even catch fire.
- **Do not over-discharge the battery. Discharging the battery too low can cause damage to the battery resulting in reduced performance and duration.**

**Li-Po cells should not be discharged to below 3V each under load. In the case of the 3S 11.1V Li-Po battery used for the Blade 400 3D, you will not want the voltage of the battery to fall below 9V during flight.**

The 25-amp brushless ESC installed on your Blade 400 model features a “soft” low voltage cutoff (LVC) that occurs when the battery reaches 9V under load. When the soft cut-off occurs, the ESC will automatically reduce power to the motor (regardless of the power level you have set with the throttle stick/curve) in order to prevent the voltage of the battery from dropping to below 9V. After the power is reduced and the voltage “rebounds” (rises) to above 9V, the ESC will automatically return power to the motor until the battery reaches 9V again. This process will continue to repeat, sometimes causing the motor/power to “pulse” rapidly, helping to provide a visual and/or audible indication of the low battery voltage. However, in some cases it may be difficult to detect pulsing of the motor/power, so we suggest that you be extremely aware of the power level of the Li-Po battery during flight. If at any time the helicopter begins to require more throttle than typical to maintain hover or flight, or has lost significant power, you must land the helicopter IMMEDIATELY to prevent a sudden loss in power that could result in a crash.

Although the soft LVC of the ESC will help to prevent “deep” (below 9V; 3V per cell) over-discharge of the battery, it is not recommended that you continue to run the motor for an extended length of time after landing and/or noticing a loss of power. Routinely discharging the battery to 9V can still cause permanent damage to the battery, resulting in shortened flight times, loss of power output or failure of the battery entirely. It is recommended that you use the timer function of the DX6i transmitter to keep the duration of each flight consistent and to prevent reaching the soft LVC each time you fly.

**Note: The timer of the DX6i transmitter included with your Blade 400 3D model has been set for 4 minutes and 30 seconds. Although it is possible to achieve longer flight durations safely depending on the performance of the battery, flying style of the pilot and other factors, we suggest using this timer setting for the first few flights. You can keep track of the flight duration on subsequent flights and adjust the setting of the timer, as you prefer. Please see the manual for the DX6i transmitter for more information regarding the timer function.**

If you have any further questions or concerns regarding the handling, charging and/or use of the included Li-Po battery pack, please contact Horizon Hobby’s Product Support staff at 877-504-0233.

## Battery Charging

**It is important that you only charge the included 3S 11.1V 1800mAh Li-Po Battery (EFLB18003S) with the included 3S 11.1V 1.8-Amp Li-Po Balancing Charger (EFLC3115). Your battery is equipped with special Charge Protection Circuitry and Balance Charge Leads with connector that are only compatible with this charger. Attempting to charge the battery using another Li-Po charger or non Li-Po compatible charger could result in serious damage. Please familiarize yourself thoroughly with the Battery Warnings and Guidelines section before continuing.**

The included 3S 11.1V 1.8-Amp Li-Po Balancing Charger will charge a near fully discharged (not over-discharged) 3S 11.1V 1800mAh Li-Po battery in approximately 1.2–1.5 hours. In some cases the charge time may be shorter depending on the actual amount of capacity left in the battery after a flight. **NEVER charge the battery unattended.**

**Note: The Li-Po battery included with your Blade 400 3D will arrive partially charged. For this reason the initial charge may only take approximately 30–50 minutes.**

The charger requires up to 3-Amps of 11.5–15 Volt DC input power that can be supplied by the optional AC to 12V DC, 3-Amp Power Supply (EFLC4030) for convenient charging anywhere an AC outlet is available. **NEVER attempt to power the charger from an AC outlet without the use of a proper AC to DC adapter/power supply.**



Input power for the charger can also be supplied by a small 12V gel cell or car battery using the included wire harness with alligator clips.



The charger is equipped with four LED indicators marked as CELL 1, CELL 2, CELL 3 and CHARGE STATUS on the label. These LEDs indicate the following (also found on the label of the charger):

- **Red Solid CELL STATUS LEDs and Red Flashing CHARGE STATUS LED:** Input power connected, battery to charge not connected
- **Green Solid CELL Status LEDs and Red Solid CHARGE STATUS LED:** Battery to charge connected and charging, balance between cells OK
- **Yellow Solid CELL STATUS LED and Red Solid CHARGE STATUS LED:** Charging and balancing cell with yellow LED
- **Red Solid CELL STATUS LEDs and Red Solid CHARGE STATUS LED:** Charge complete
- **Red and Green Flashing CELL STATUS LEDs and Red Solid (or flashing) CHARGE STATUS LED:** Charge error

Use care to ensure proper polarity (as marked on the bottom of the charger case) when connecting the charger to a power source. Once you have connected the charger to the power source, its CELL STATUS LEDs will glow solid red and the CHARGE STATUS LED will flash to indicate the charger has power and is ready to begin charging. Connect the Li-Po battery to the charger using the specially marked Balance Charge Lead exiting the battery and the mating connector on the side of the charger labeled with 11.1V. The balance connector is keyed to prevent reverse polarity connection.

**Note:** Be sure to place the battery and charger on a smooth, heat-resistant surface during charging.

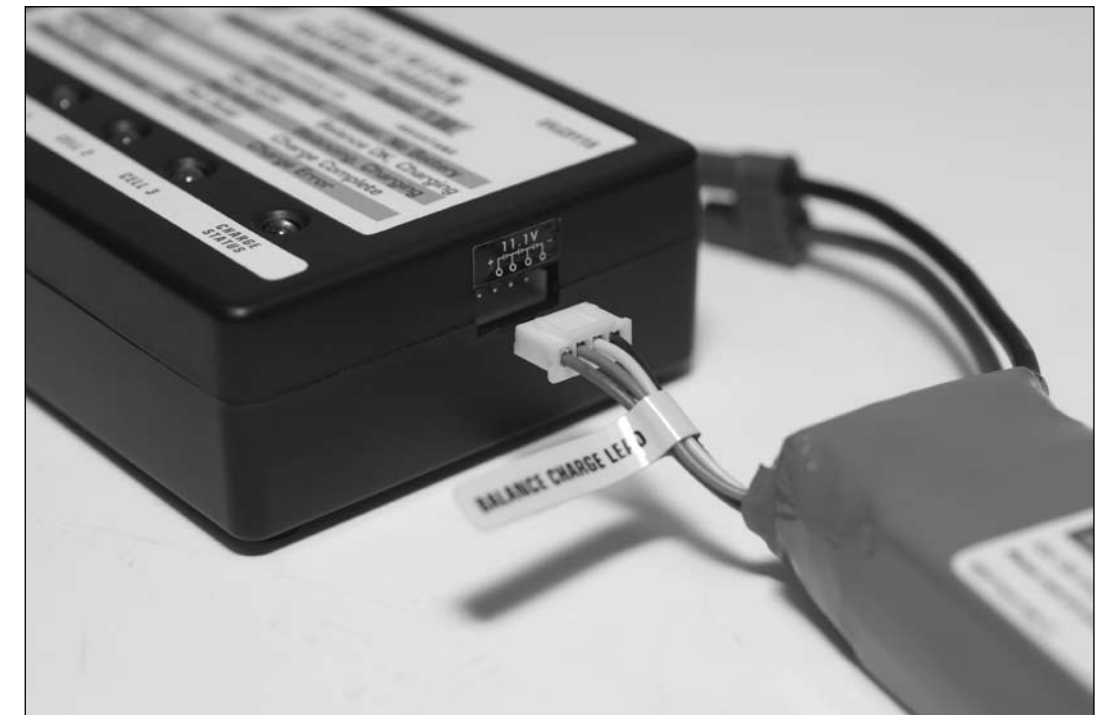

When the battery is properly connected and charging normally, the CHARGE STATUS LED will glow solid red and the CELL STATUS LED indicators will glow solid green when the voltage balance between the cells is OK. If the CELL STATUS LED for any cell is glowing yellow while the CHARGE STATUS LED is solid red, the indicated cell will be balanced (charged) so its voltage closely matches that of the other two cells and the “full” charge voltage. Once the battery has been fully charged, the CELL STATUS and CHARGE STATUS LEDs will glow solid red. The battery can now be removed from the charger and installed in the Blade 400 3D for flight.

## Charge Errors and Indications

**In the event that any CELL STATUS LED flashes red and green while the CHARGE STATUS LED glows solid or flashes red, a charge error has occurred. Some examples of charge errors include:**

- If any CELL STATUS LED flashes red and green while the CHARGE STATUS LED flashes red, the voltage of the indicated cell(s) is below 2.5V. In this case the voltage of the indicated cell(s) is too low to allow the charge process to begin.

If only one or two CELL STATUS LEDs flash red and green (while the CHARGE STATUS LED flashes red), the balance connector connections for the indicated cell(s) may not be making good contact with the charger's mating connector. Be sure to double-check the connections to ensure they are making good contact. If the connections are making good contact, the indicated cell(s) may have failed or dropped to a voltage that no longer allows the battery to be charged safely.

In the event that all three CELL STATUS LEDs flash red and green (while the CHARGE STATUS LED flashes red), the battery was likely overdischarged. Although the Electronic Speed Control (ESC) installed on your Blade 400 3D model is programmed to help prevent deep overdischarge of the Li-Po battery, you must exercise proper care of the battery if it is used in another application. You must also be sure that the battery is never left plugged into the ESC for an extended period of time after flying in order to prevent overdischarge.

**Anytime one or more CELL STATUS LEDs flash red and green while the CHARGE STATUS LED flashes red, you should remove the Li-Po battery from service and replace it with a new one.**

- If any CELL STATUS LED flashes red and green while the CHARGE STATUS LED glows solid red, the charge process for the indicated cell(s) has been interrupted. In this case, the balance connector connections for the indicated cell(s) may not be making good contact with the charger's mating connector. Double-check the connections to ensure they are making good contact, and then begin the charge process again.

If you have any further questions or concerns regarding charge error indications, please contact Horizon Hobby's Product Support staff at 877-504-0233

## Installing the Transmitter Batteries

Install the 4 included AA batteries in the Spektrum DX6i transmitter. Check the power level of the batteries and operation of the transmitter by switching the power switch on (to the right). The voltage display on the LCD screen at the bottom of the transmitter will indicate the power level of the batteries. If at any time the voltage of the batteries falls to 4.3V or less, an alarm will sound, and it will be necessary to replace the batteries with new ones.



## Installing the Flight Battery

Use the included hook and loop material for mounting the Li-Po battery. We suggest installing the “loop” (fuzzy) material on the battery and the “hook” material on the battery support located at the front of the main frame. Install the hook and loop material on the battery so the main power wire leads with the blue EC3 connector are oriented to the right side of the helicopter (when viewing the helicopter from behind). This will help to keep the wire leads from interfering with the elevator servo on the left side of the model.

Also, be sure that the battery is positioned so that it will not come into contact with the elevator servo arm and the motor case. If the battery comes into contact with either of these components during flight, it can result in damage to the battery, motor and/or servo, potentially resulting in a crash.

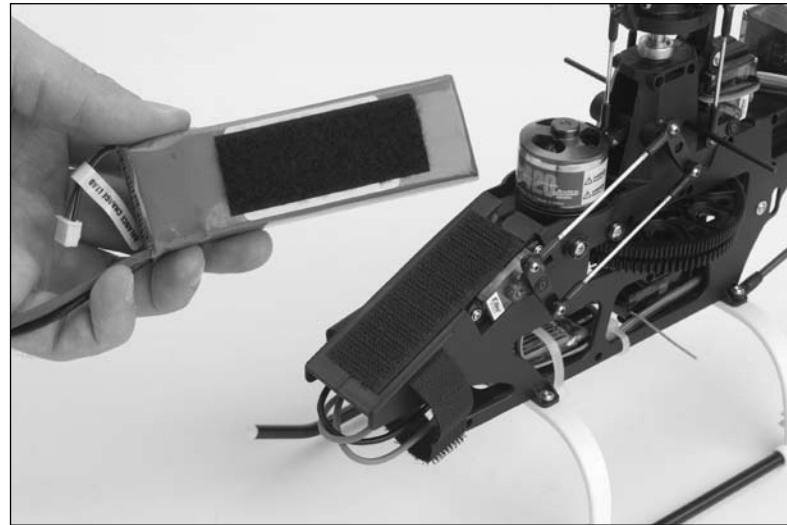

Once the battery has been properly positioned, fasten the hook and look strap around the battery for added security.

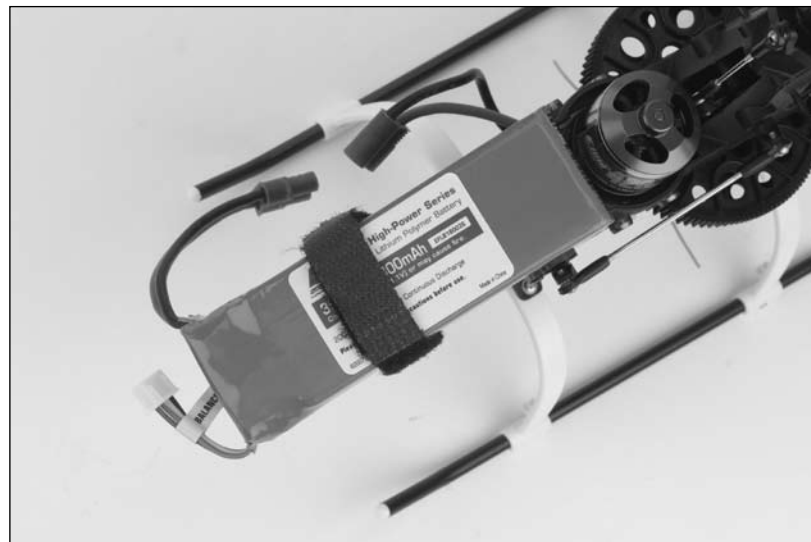

## Control Test

Although each Blade 400 3D model is control tested at the factory, it is a good idea to test the controls prior to the first flight to ensure none of the servos, linkages or other parts were damaged during shipping and handling. Before proceeding, disconnect the three bullet connectors between the motor and ESC. It is not safe to perform the control test with the motor connected to the ESC.



Turn the transmitter on first and lower the throttle/collective (left-hand) stick completely.



Then, plug the battery into the battery lead of the ESC.



Position the helicopter to view it from the left or right side. Move the left-hand stick up and down to check the collective pitch control. When the stick is pushed up, the swashplate should lower, increasing the pitch of the main blades.

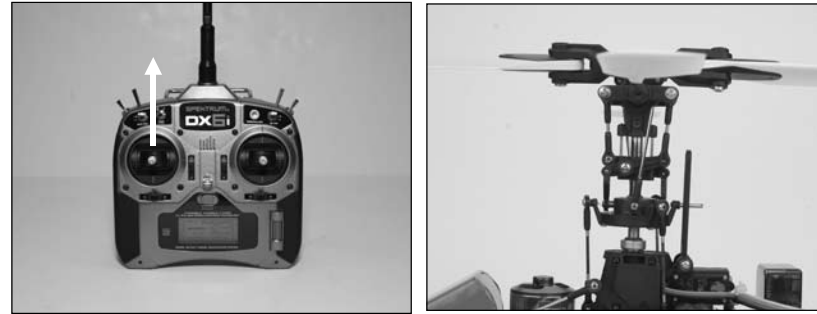

With the stick pulled back down, the swashplate should raise, decreasing the pitch of the main blades.



Again viewing the helicopter from the left or right side, move the right-hand stick forward and aft to check elevator pitch control. When the stick is pushed forward, the swashplate should also tilt forward.

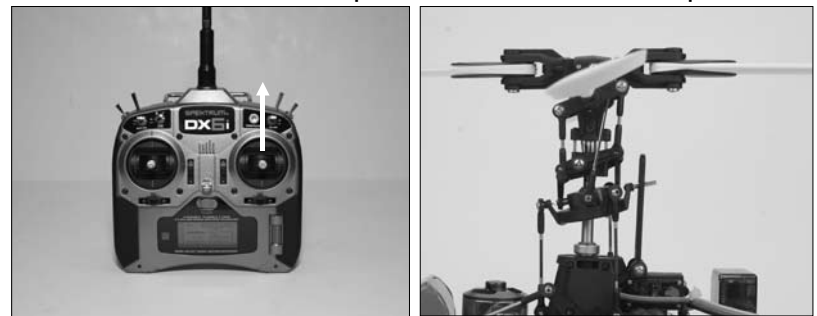

With the stick pulled back, the swashplate will tilt toward the rear.

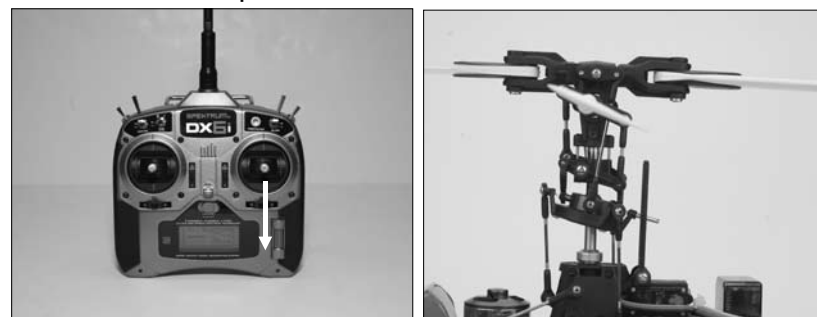

While viewing the helicopter from the rear (tail boom toward you), move the right-hand stick left and right to check aileron roll control. When the stick is pushed to the left, the swashplate should also tilt left.

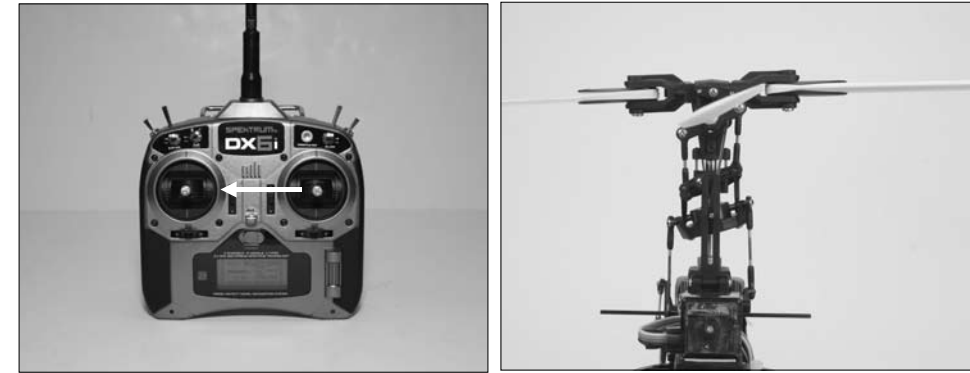

With the stick pushed right, the swashplate will tilt to the right.

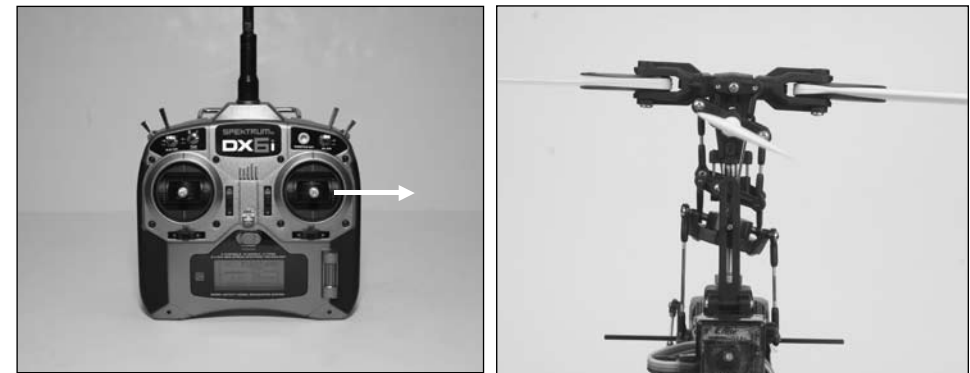

While viewing the helicopter from the rear (tail boom toward you), move the left-hand stick left and right to check rudder/tail rotor pitch control. When the stick is pushed to the left, the tail pitch slider should move to the right.



With the stick pushed right, the tail pitch slider should move to the left.



If at any time during the test the swashplate controls do not respond properly, double-check the swashplate mixing (SWASH MIX) settings in the transmitter (see the manual for the DX6i for more information). The values should be set as follows:

AILE -75%  
ELEV -75%  
PITCH +85%

If the swashplate controls still do not respond properly after ensuring that the swashplate mixing values are correct, or if the rudder/tail rotor pitch control is not responding properly, double-check the servo reversing (REVERSE) settings in the transmitter (see the manual for the DX6i for more information). They should be set as follows:

THRO – N (Normal)  
AILE – R (Reverse)  
ELEV – N (Normal)  
RUDD – R (Reverse)  
PITC – N (Normal)

If the controls still do not respond properly after ensuring the servo reversing switch positions are correct, you may also check the servo connections to the receiver. The connection for each servo (when viewing the helicopter from behind) should be connected to the receiver as follows:

AILE – Lower rear-mounted swashplate control “aileron” servo  
ELEV – Forward-mounted swashplate control “elevator” servo  
RUDD – Rear-mounted tail rotor pitch control “rudder” servo  
AUX1 – Upper rear-mounted swashplate control “pitch” servo

Once you have confirmed proper swashplate mixing values, servo reversing settings and servo connection locations, all controls should be functioning properly. However, if you continue to encounter any problems relating to your Blade 400 3D responding properly to the transmitter, do not fly. Call Horizon’s Product Support staff at 1-877-504-0233 before proceeding.

If you have confirmed proper control operation of your Blade 400 3D, unplug the flight battery from the ESC and reconnect the three bullet connectors between the motor and ESC, taking care to connect the like-color leads to one another (black to black, blue to blue and red to red) to ensure proper operation of the motor.

## Electronic Speed Control (ESC) Features, Arming and Motor Control Test

Your Blade 400 3D model is equipped with a 25-amp brushless ESC that is specifically designed for use in helicopter models.



The ESC is not programmable for use in other applications, however, it is equipped with features and functions that optimize its performance for the Blade 400. These features and functions include:

### • “Soft” Low Voltage Cutoff

The ESC features a “soft” low voltage cutoff (LVC) that occurs when the battery reaches approximately 9V under load. This helps to prevent “deep” overdischarge of the Li-Po battery during use. Please see the Battery Warnings and Guidelines section for more information regarding the soft LVC feature and how to prevent overdischarge of the Li-Po battery.

### • Soft (Slow) Start

The soft (slow) start function of the ESC is intended to help prevent potential damage of the geartrain, motor and ESC by softly (slowly) “ramping up” (increasing) power to the motor (particularly when the rotor blades are not already spinning). The first time you “power up” the ESC after it has been powered on and armed, it will take approximately 15 seconds for the ESC/motor to reach the power level you initially set with the throttle stick/curve. This means you will need to wait approximately 15 seconds before attempting any aggressive maneuvering as you should allow the power system to reach the set level of power first.

Any time (after the initial soft startup occurs) the ESC/motor have been powered down completely (to 0% power) for approximately 15 seconds or more, the soft start will occur again. This is particularly helpful if you land the helicopter to make an adjustment as you will not need to re-arm the ESC in order to perform a soft startup. It is simply best to wait approximately 15 seconds before powering up the ESC/motor again for flight.

### • Fast Start

The fast start function of the ESC is intended to allow any level of power to be applied almost immediately after ESC/motor have been powered down completely (to 0% power) for any amount of time less than approximately 15 seconds. This is particularly helpful if you accidentally bump the Throttle Hold switch or when aborting an auto-rotation attempt as it will allow the ESC/motor to reach any power level you have set with the throttle stick/curve almost immediately when the Throttle Hold switch is set back to the OFF (0) position.

The following checklist includes the steps you must follow to ensure proper arming and operation of the ESC (as well as proper operating direction of the motor and rotor blades):

- Each time before you fly you must ALWAYS turn on the transmitter power first before connecting the flight battery to the ESC. Never connect the flight battery to the ESC before powering on the transmitter first. After each flight, be sure that you never turn off the transmitter before disconnecting the flight battery from the ESC first.

**Note: The antennas exiting the Spektrum AR6100e receiver should extend outward (to the left and right of the helicopter) as much as possible for the best overall performance. Be sure to double-check the position and orientation of both antennas before each flying session, especially if the helicopter was taken out of a box or carrying case.**

- The throttle (left-hand) stick MUST be in the lowest possible position, with the throttle trim set in approximately the middle position, in order for the ESC to arm. Also, the Flight Mode (F MODE) switch must be in the “Normal” (0) position with the switch toggled toward the back of the transmitter. The Throttle Hold (TH HOLD) switch should be set in the “Off” (0) position, however, the ESC will still arm if the switch is set in the “On” (1) position and the “Hold” throttle curve values are all set to 0%.

**Note: In some cases it may be possible to arm the ESC with the throttle stick set to a position that is higher than the lowest possible position. While the ESC may still function in this situation, it is best to re-arm the ESC with the throttle stick in the lowest possible position in order to ensure the best performance of the ESC overall.**

- ❑ After confirming that the transmitter has been turned on and has an adequate level of battery power (as displayed on the LCD screen at the bottom of the transmitter), and that the throttle stick is in the lowest possible position, it is now safe to connect the flight battery to the ESC.

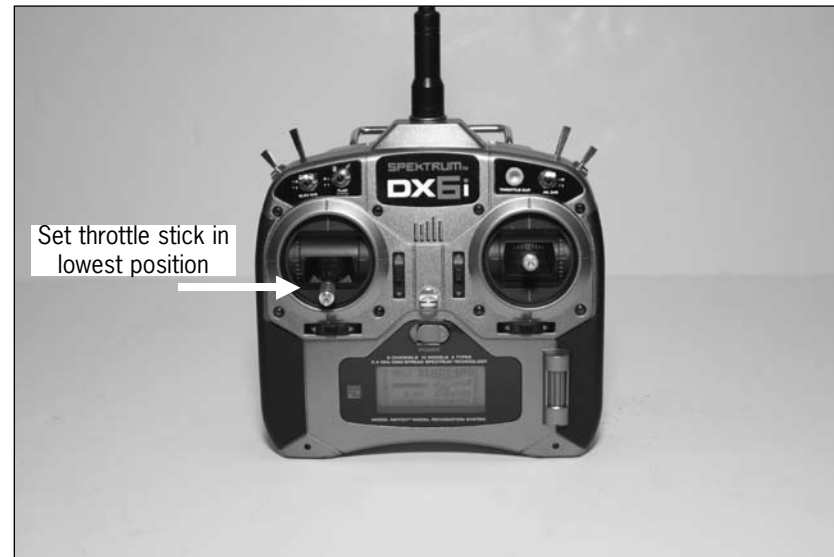

- ❑ With battery power applied, you will hear two “beeps” once the ESC has armed properly. Use caution as the motor, main rotor and tail rotor blades will now run with throttle stick input. For safety, we suggest setting the Throttle Hold (TH HOLD) switch in the “On” (1) position once the ESC has armed. This will keep the motor and rotor blades from running while you handle the helicopter and transmitter (as long as the throttle curve values for the “Hold” flight mode are all set to 0%, as they are from the factory).

If you have not set the Throttle Hold switch to the “On” position, or after you set the switch to the “Off” (0) position, DO NOT advance the throttle stick until you are clear of the rotor blades.

**Note: If you do not hear two beeps after battery power is applied, the ESC has not armed properly. Please review the following:**

- ❑ Confirm that the throttle stick is in the lowest possible position and that the throttle trim is set in approximately the middle position.
- ❑ Confirm that the Flight Mode (F MODE) switch is set to the “Normal” (0) position.
- ❑ Confirm that the low (L) position (POS) value for the normal (NORM) throttle curve (THRO CUR) is set to 0%.
- ❑ Confirm that the travel adjustment (TRAVEL ADJ) value for the throttle (THRO) channel is set to 100% in the low position.

If the ESC will not arm after confirming the details listed above, contact Horizon Hobby’s Product Support staff at 1-877-504-0233 before proceeding.

- ❑ Once you have placed the helicopter in a safe area, free of obstructions, and are clear of the rotor blades, you can safely begin to power up the model to confirm proper operation and operating direction of the motor and rotor blades.
- ❑ Advance the throttle stick slowly, just until the motor and rotor blades begin to spin. Note the direction that the main and tail rotor blades spin. The main rotor blades should spin clockwise when viewed from the top, and the tail rotor blades should spin counterclockwise when viewed from the right-hand side of the helicopter. If both sets of rotor blades are operating in the wrong direction, power down the helicopter, unplug the flight battery, then simply reverse the position of

any two motor wire lead connections to the ESC.

**Note: If the main rotor blades are operating in the correct direction but the tail rotor blades are not, the belt driving the tail rotor may be “twisted” in the wrong direction. To correct this, remove the tail rotor case and parts from the tail boom and pull the belt “straight” (so it is horizontal and has no twists). Then, rotate the belt 90 degrees clockwise when viewing the helicopter from behind.**

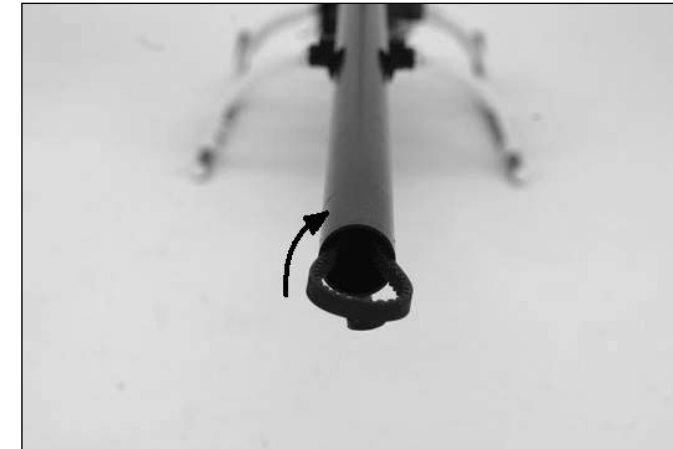

**Reinstall the tail rotor case and other parts, then, double check proper operating direction of the tail rotor blades by spinning the main rotor blades in the clockwise direction (when viewed from the top) by hand. The tail rotor blades should now spin counterclockwise (when viewed from the right-hand side of the helicopter).**

- ❑ After confirming that both sets of rotor blades are operating in the correct directions, please be sure to review the following sections of the manual BEFORE proceeding with the first flight.

### Gyro Initialization, Response Test and Adjustment

Your Blade 400 3D model is equipped with an E-flite G110 Micro Heading Lock Gyro. This gyro offers an excellent blend of size, weight, features and performance.



## Initialization and Response Test

The following checklist includes the steps you must follow to ensure proper initialization and operation of the gyro:

- ❑ After connecting the flight battery to the ESC, be sure that you do not move or sway the helicopter. Allow it to remain motionless until the red LED on the gyro illuminates solidly, indicating that the gyro has initialized properly and is ready for use.

**Note: It is extremely important that you do not move or sway the helicopter after powering it on and before the gyro initializes. The gyro must be allowed adequate time to record the neutral position in order to initialize for proper operation. If you accidentally move the helicopter after powering it on and before the gyro initializes, power the helicopter off (by disconnecting the flight battery from the ESC) then repeat the process to power the helicopter on and to initialize the gyro properly.**

- ❑ Once the gyro has initialized properly, we suggest setting the Throttle Hold (TH HOLD) switch to the "On" (1) position for added safety during the response test.
- ❑ Before making your first flight, it will be necessary to confirm that the gyro is responding properly to the movements of the helicopter and providing proper inputs to the tail servo in order to counteract any unwanted changes in yaw. To do this, view the servo arm (from the top of the servo) and note the direction the arm rotates when you give a right rudder input on the transmitter (while the model remains motionless). In the case of the DS75H servo installed on your Blade 400 model, the servo arm should rotate toward the front of the helicopter. Then, yaw the nose of the helicopter quickly to the left, while again noting the direction the tail servo arm rotates. The arm should rotate in the same direction as it did for a right rudder command (toward the front of the helicopter). If the servo arm rotates in the opposite direction, switch the position of the Reverse switch located on the side of the gyro. The switch should be set to the Normal (NOR) position. Then, repeat the steps above to confirm that the gyro is now providing proper inputs to the tail servo.
- ❑ After confirming that the gyro is providing proper inputs to the tail servo, power off the helicopter and be sure to review the following sections of the manual BEFORE proceeding with the first flight.

## Gyro Mode and Gain Adjustments:

- The G110 offers a Dual Remote Gain Adjustment feature. This, along with the DX6i's Gyro Sensitivity feature, allows the gyro mode (Standard Rate or Heading Lock) and gain values to be set remotely in the transmitter. This means that the Gain Setting Adjustment Pot located on the gyro itself will not be active and will not be used for adjusting gain values.
- The gain values for the gyro are adjusted in the Gyro Sensitivity (GYRO) menu of the transmitter. And because the switch (SW) selection choice has been set to the Gyro (GYRO) switch, the two available gain values can be selected using this switch during flight. When the Gyro switch is toggled in the upward (0) position, the gain value will be equivalent to the Rate (RATE) set on the first (0:) line. When the Gyro switch is toggled in the downward (1) position, the gain value will be equivalent to the Rate (RATE) set on the second (1:) line. Please see the manual for the DX6i for any additional information you may require.
- When the Rate for either Gyro switch position is set to 0%, it is equivalent to an approximately 100% gain value in the Standard Rate (non-Heading Lock) mode.

When the Rate for either Gyro switch position is set to 25%, it is equivalent to an approximately 50% gain value in the Standard Rate (non-Heading Lock) mode.

When the Rate for either Gyro switch position is set to 50%, it is equivalent to an approximately 0% gain value in the Standard Rate (non-Heading Lock) mode.

- When the Rate for either Gyro switch position is set to 75%, it is equivalent to an approximately 50% gain value in the Heading Lock mode.

When the Rate for either Gyro switch position is set to 100%, it is equivalent to an approximately 100% gain value in the Heading Lock mode.

In the case of the Blade 400 3D, it is generally preferred to fly with the gyro set to the Heading Lock mode. This means that the Rate for either Gyro switch position should not typically be set to below approximately 60% (an approximately 20% gain value in the Heading Lock mode).

- While you can set and select between two different Modes and Rates using the Gyro switch, two slightly different Rates have been set for the same Mode (Heading Lock) from the factory. The Rate/value is slightly higher when the Gyro switch is set in the upward (0) position than it is in the downward (1) position. After your first few flights you can experiment with different values in each position to find the values that work best depending on your flying style and flying conditions. For example, it may be desirable to use a higher gain value when flying in the Normal flight mode, and/or a lower gain value when flying in windy conditions. The DX6i also allows you the option to set gain values for each specific flight mode. This can be accomplished by setting the gyro switch (SW) selection to Flight Mode (F. MODE) (please see the manual for the DX6i for more information.)
- During your first flight, establish a stable hover and apply some short and quick rudder inputs while observing the reaction of the tail when the control stick is returned to its neutral position. If there is any tendency for the tail to twitch quickly (oscillate) from side to side, it will be necessary to lower the Rate used for the selected Gyro switch position.

The goal when adjusting the Rate for one or both of the Gyro switch positions is to find the highest gyro gain value (Rate) at which the tail of the helicopter will not oscillate in nearly all areas of flight, including fast forward flight and descents. In some cases it may not be possible to use the same Rate for hovering (in the Normal flight mode for example) and fast forward flight/aerobatics (in the Stunt flight mode for example). By setting two different Rates for each Gyro switch position, it will allow you to select the best Rate (using the Gyro switch) depending on the flight mode you are using and the type of flying you are doing at any given time. This can be particularly helpful when flying in windy conditions, as it may sometimes be necessary to switch to a lower Rate in flight to prevent significant tail oscillation when performing certain maneuvers.

## Trim Adjustments

- During flight, it may be necessary to make some small adjustments to the rudder trim in order to prevent the nose/tail of the model from "drifting" to the left or right when the rudder stick is in the neutral position. Typically, only a small amount of adjustment may be necessary.

**Note: It is always best to avoid sudden temperature and environmental condition changes when using a gyro. For example, it is best to not fly a model on a very hot (or cold) day immediately after removing it from an air-conditioned (or heated) vehicle. It is also best to keep the gyro out of direct sunlight and away from any heat-generating sources on the model.**

To help the gyro better acclimate to temperature and environmental conditions at the flying field, it is best to let your Blade 400 3D model stand for approximately 10–15 minutes before flying, allowing the temperature of the gyro sensor to stabilize. If you do not allow the temperature to stabilize, you may experience radical trim changes that require significant adjustments of the rudder trim during flight.

## Servo Mode Setting

- The G110 is equipped with a switch and software that allows its performance to be optimized for use with most analog and some digital servos. The Servo Mode selection switch can be found on the side of the gyro.
- When the Servo Mode selection switch is set in the Standard (STD) position, the gyro is optimized for use with most analog servos. It is also optimized for use with digital servos that are not designed to accept a pulse rate of 275Hz or higher. **And although the DS75H rudder/tail servo installed on your Blade 400 3D model is a digital servo, it is not designed to accept a pulse rate of 275Hz. As a result, you must be certain that the Servo Mode selection switch is set to the Standard position when the DS75H servo is being used.**

**Note: Do not use analog or digital servos that are not designed to accept a pulse rate of 275Hz with the Servo Mode selection switch set to the Digital Servo (DS) position. If either type of servo is used with the gyro set to the Digital Servo mode, it will reduce the operating life of the servo, typically causing the servo to fail within a few minutes of use or after a few flights.**

- When the Servo Mode selection switch is set in the Digital Servo (DS) position, the gyro is optimized for use with digital servos that are designed to accept a pulse rate of 275Hz. Some such servos include the Spektrum DSP60 and DSP75, as well as the JR 3400G. Again, although the DS75H tail servo installed on your model is a digital servo, it is not designed to accept a pulse rate of 275Hz. Be certain that the Servo Mode selection switch is set to the Standard position when the DS75H servo is being used.

## Understanding the Primary Flight Controls

If you are not familiar with the primary flight controls of your Blade 400 3D, please take a few minutes to familiarize yourself with them before proceeding and before attempting your first flight.

The left-hand stick on the transmitter controls both throttle/collective pitch (climb/descend) and rudder (yaw left/right). When the left-hand stick is in the lowest position and the throttle trim is set to approximately the middle position, the motor and rotor blades will not spin (when in the Normal or Throttle Hold flight mode). Advancing the stick upward will increase the speed and pitch of the main rotor blades. Increasing the speed and pitch of the main rotor blades will cause the model to climb.

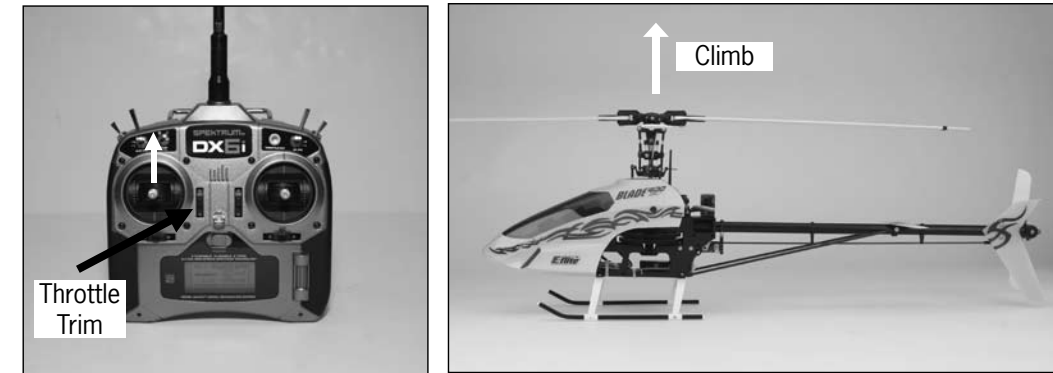

Decreasing the speed and pitch of the main rotor blades by lowering the left-hand stick will cause the model to descend.

**Note: When you are in the Stunt/Idle Up flight mode, lowering the left-hand stick will actually cause the speed of the main rotor blades to increase while also increasing the amount of negative pitch the main rotor blades can offer. This allows the model to be flown inverted and to perform aerobatics like loops, rolls and 3D flying.**

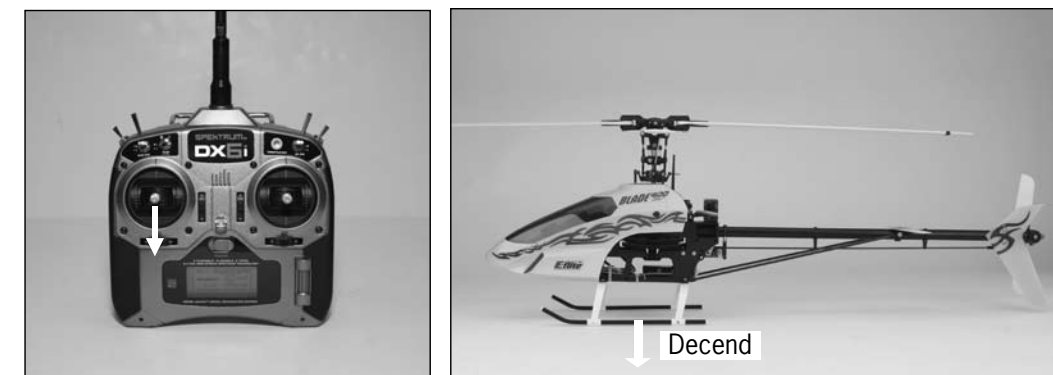

After lifting the model off the ground you can balance the throttle/collective pitch by carefully moving the left-hand stick up and down so that the model will hold a stationary hover without climbing or descending.

Also, in most cases it will not be necessary to adjust the throttle trim from the middle position for any reason.

Moving the left-hand stick to the left will turn (yaw) the nose of the helicopter to the left about the axis of the main shaft. This is accomplished by changing the pitch of the tail rotor blades.

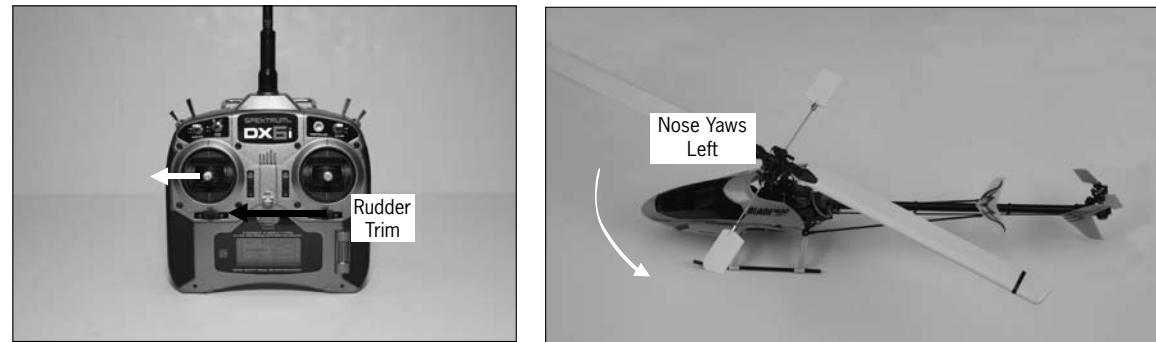

Moving the stick to the right will turn (yaw) the nose of the helicopter to the to the right about the axis of the main shaft.

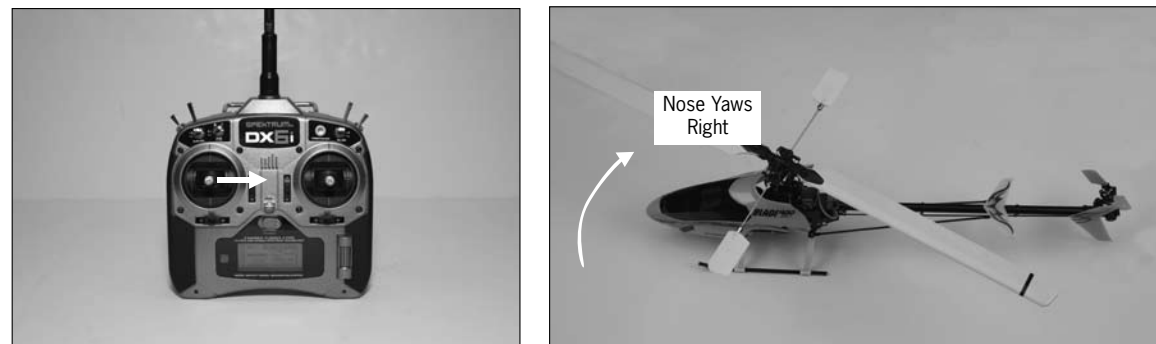

The rudder trim can be used to help keep the nose of the helicopter from rotating to the left or right when in hover with no rudder stick input. For example, if the nose of the helicopter drifts to the right when in hover, click the rudder trim lever to the left until the nose stays as close to straight as possible.

The right-hand stick controls both elevator (pitch fore/aft) and aileron (roll). Pushing the stick forward will pitch the nose of the helicopter downward, allowing the helicopter to be flown forward and to perform forward flips.

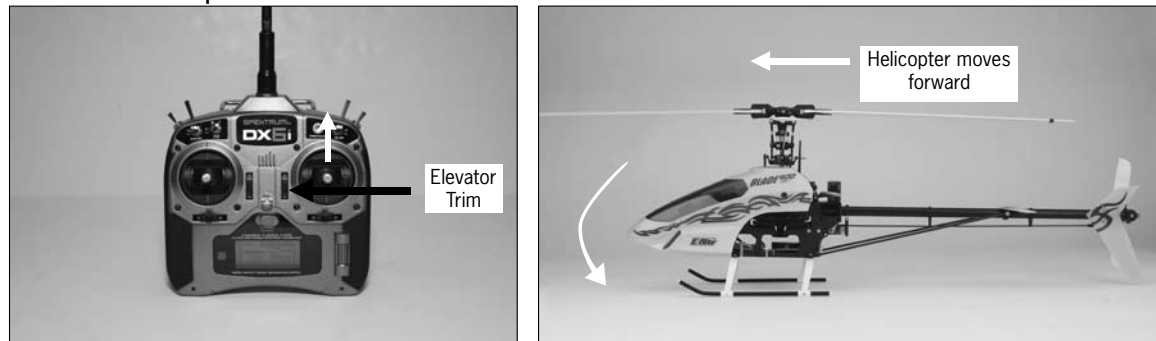

Pulling the stick backward will pitch the tail of the helicopter downward, allowing the helicopter to be flown backward and to perform backward flips.

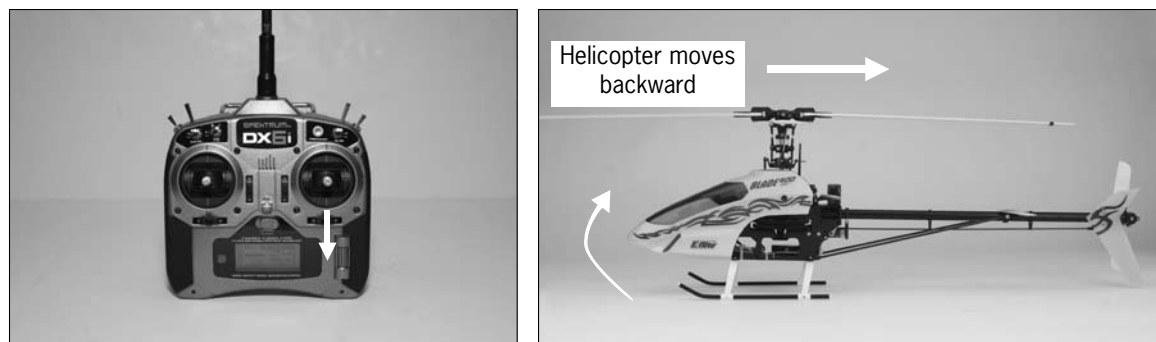

The elevator trim can be used to help keep the helicopter from drifting forward or backward when in hover with no elevator stick input. For example, if the helicopter drifts forward when in hover, click the elevator trim lever downward until the helicopter hovers as level as possible with no forward drifting.

Moving the stick to the left will roll the helicopter to the left, allowing the helicopter to be flown to the left and to perform left-hand rolls.

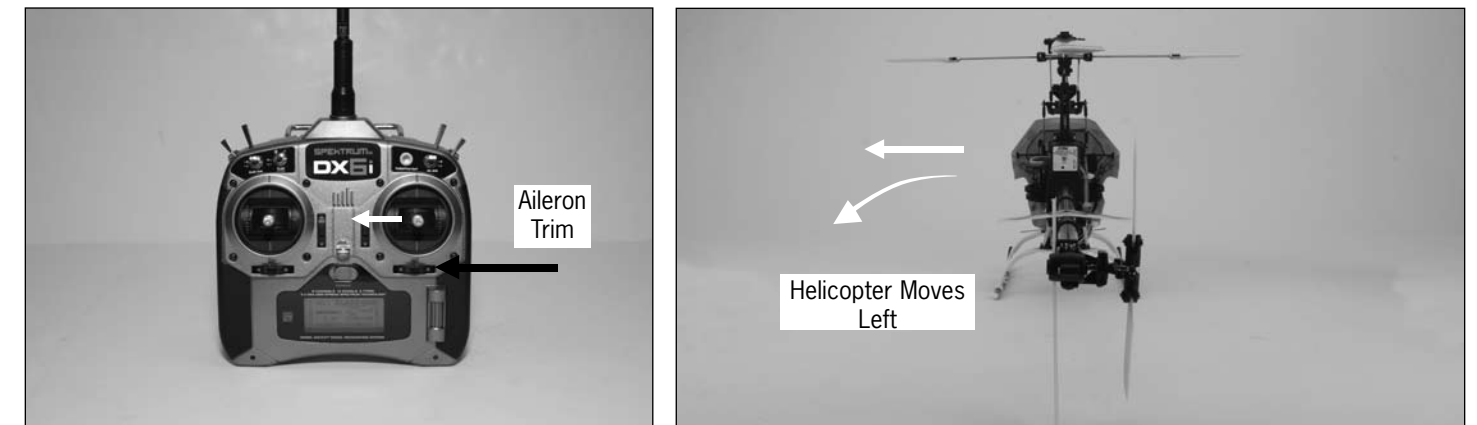

Moving the stick to the right will roll the helicopter to the right, allowing the helicopter to be flown to the right and to perform right-hand rolls.

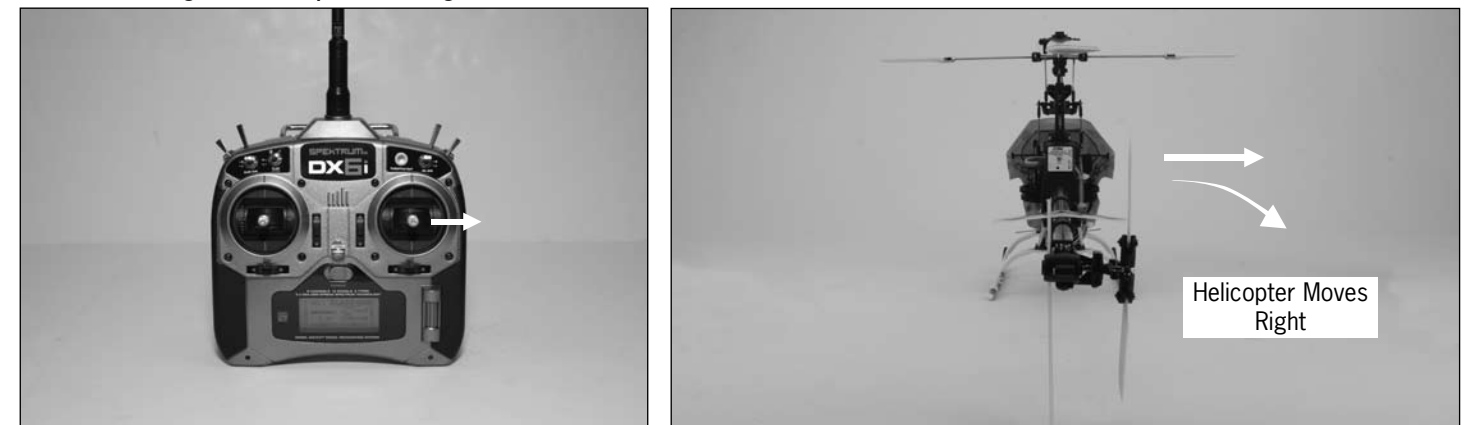

The aileron trim can be used to help keep the helicopter from drifting left or right when in hover with no aileron stick input. For example, if the helicopter drifts to the right when in hover, click the aileron trim lever to the left until the helicopter hovers as level as possible with no drifting to the right.

Once you have become familiar with the primary controls of the helicopter, you are almost ready to fly.

## Normal and Stunt Flight Modes

The Spektrum DX6i transmitter included with your Blade 400 3D features a Flight Mode (F. MODE) switch. This switch allows the pilot to toggle between the "Normal" (0) and "Stunt/Idle Up" (1) flight modes during flight.

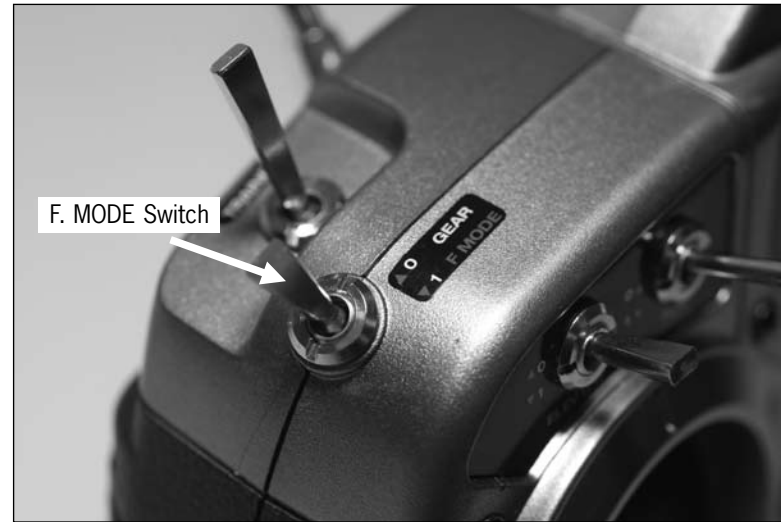

When the Flight Mode switch is toggled toward the rear of the transmitter (position 0), the Blade 400 3D will be in the Normal (NORM) flight mode. In this flight mode, the throttle curve is linear from 0% to 100%, with a pitch range of approximately -3 degrees (35%) to +10 degrees (100%). This is the preferred flight mode for general hovering and basic (non-aerobatic) flight.

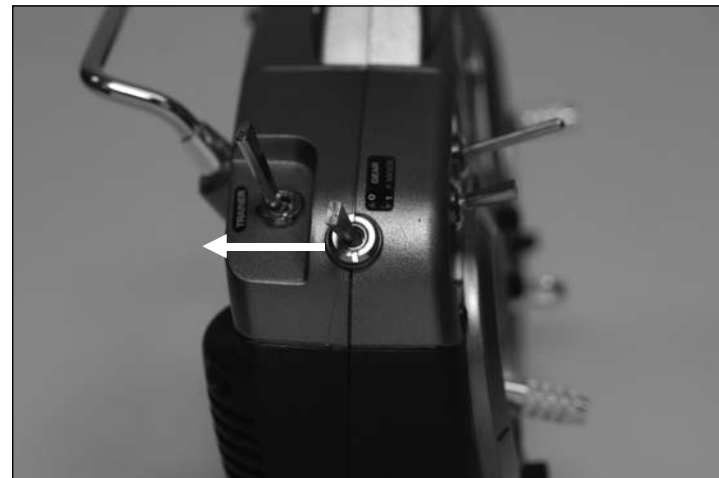

THROTTLE CURVE

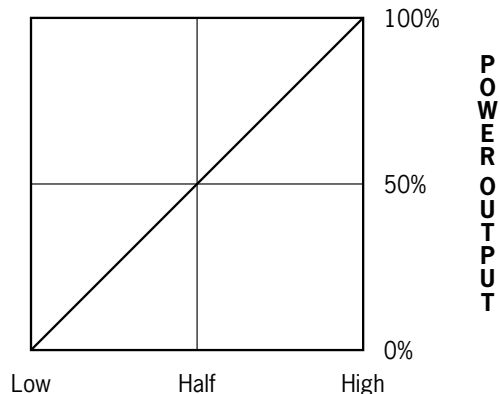

STICK POSITION

PITCH CURVE

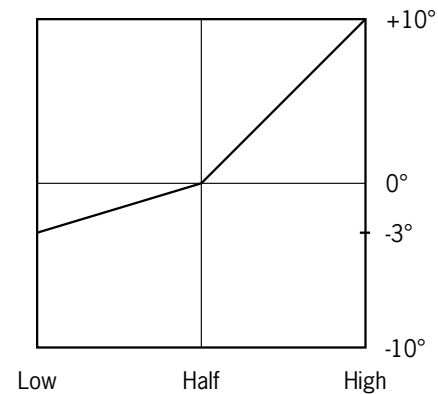

STICK POSITION

When the Flight Mode switch is toggled toward the front of the transmitter (position 1), the Blade 400 3D will be in the Stunt/Idle Up (STUNT) flight mode. In this flight mode, the throttle curve is "V" shaped from 100% to 100% with 85% throttle at mid-stick, with a pitch range of -10 (0%) to +10 degrees (100%). This is the preferred flight mode for most forward/backward, aerobatic and 3D flying.

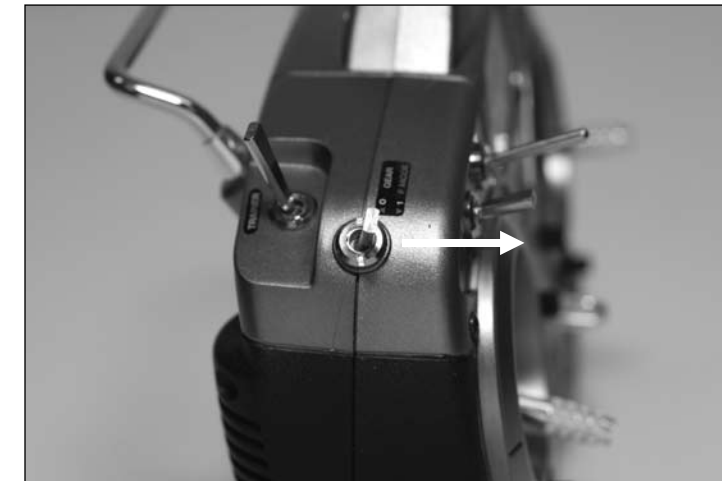

THROTTLE CURVE

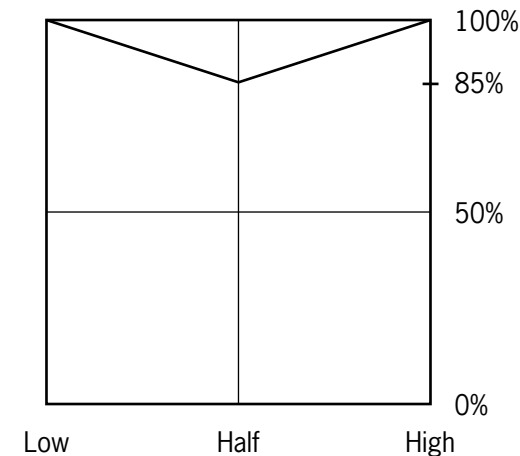

STICK POSITION

PITCH CURVE

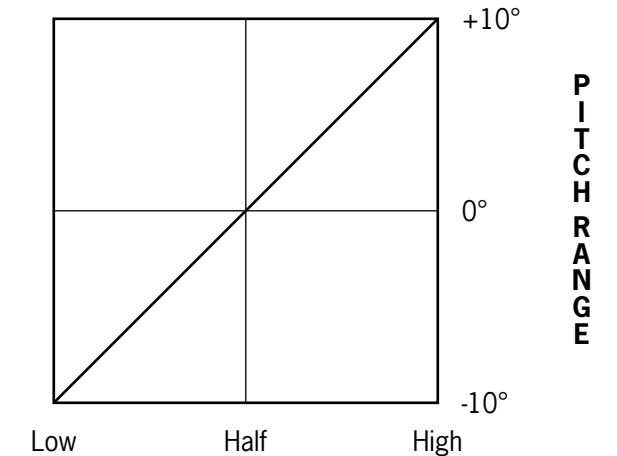

STICK POSITION

**Note:** When in the Stunt flight mode, even with the throttle stick pulled all the way down to its lowest possible position, the motor and rotor blades will continue to spin aggressively. You must use the Normal flight mode (or Throttle Hold) to safely power down the motor and rotor blades. For added safety, the ESC will not arm if the flight battery is plugged in and the flight mode switch is set to the Stunt position.

When switching between the Normal and Stunt flight modes, it is typically best to do so in the air while hovering. The throttle and pitch curves of each flight mode have been optimized to transition smoothly around hover.

**Note:** Although the midpoint (point 3) of the throttle curve in the Stunt flight mode has been factory-set to 85% to provide good overall sport and 3D aerobatic performance, this value (as well as the values for points 2 and 4) can easily be adjusted to better suit the pilot's preference. Pilots new to this class of model, or those that may not require the most aggressive performance, may prefer to reduce the value of the midpoint to approximately 70%. This will reduce the headspeed in upright and inverted hover, as well as at mid-stick, often times helping to make it easier (smoother) and less intimidating to fly the model. However, if you reduce the value of the midpoint (point 3), it will also be necessary to adjust the values of points 2 and 4 in order to achieve the best performance. In

general, it is usually preferred to simply “split the difference” between the values of the lowest point (point L) and the midpoint (point 3), as well as the highest point (point H) and the midpoint. For example, if the lowest and highest points are set to 100%, and the midpoint is set to 70%, points 2 and 4 should be set to 85%.

Pilots interested in the most aggressive performance for added cyclic and collective pitch response may prefer to increase the value of the midpoint (as well as the values for points 2 and 4 as necessary). Please see the manual for the DX6i for more information on throttle curve settings and adjustments.

### Throttle Hold

The Spektrum DX6i transmitter also features a Throttle Hold (TH HOLD) switch. This switch allows the pilot to toggle between the Throttle Hold “Off” (0) and Throttle Hold “On” (1).

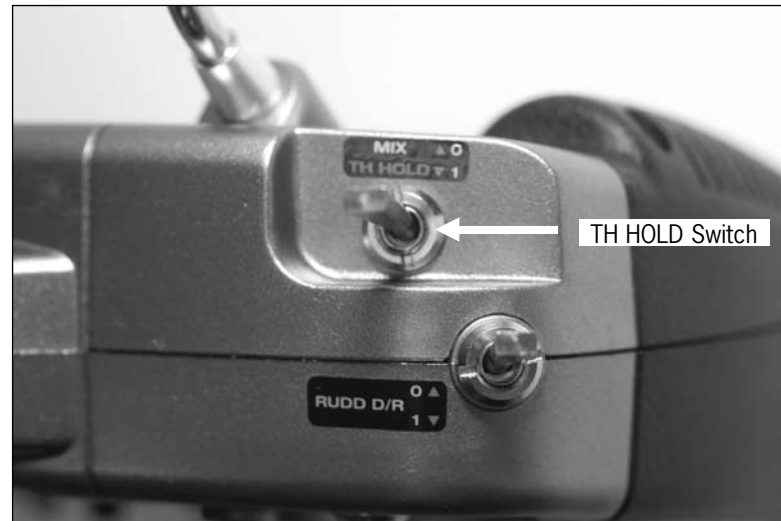

When the Throttle Hold switch is toggled toward the rear of the transmitter (position 0), Throttle Hold will be “Off.” When Throttle Hold is off, the transmitter will be in the Normal or Stunt flight mode (depending on the position in which the F MODE switch is set).



When the Throttle Hold switch is toggled toward the front of the transmitter (position 1), Throttle Hold will be “On” (activated). When Throttle Hold is on, the helicopter will be in the Throttle Hold (HOLD) flight mode. In this flight mode, the throttle curve is linear from 0% to 0%. In the case of an electric-powered model like the Blade 400, this will power down the ESC/motor completely. And, because the pitch range in this flight mode is approximately -3 degrees (35%) to +10 degrees (100%), it also allows you to perform auto-rotations during flight if you choose.



#### THROTTLE CURVE

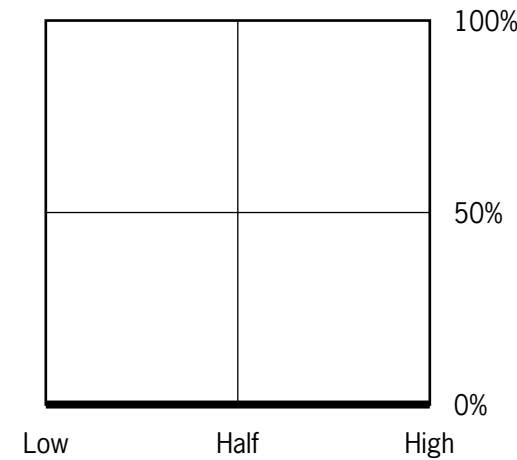

#### PITCH CURVE

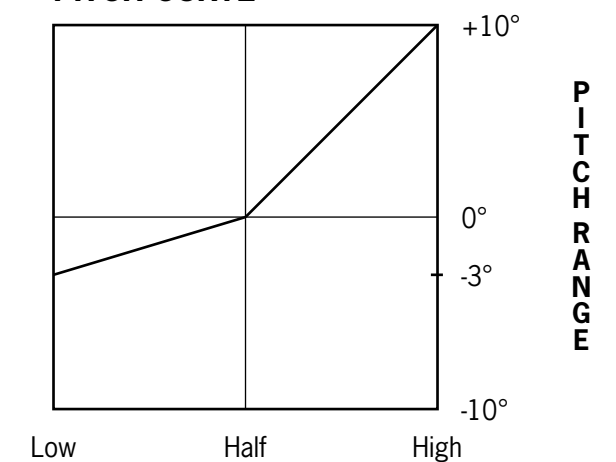

#### STICK POSITION

Toggling the Throttle Hold switch to the on position also allows you to safely power down the ESC/motor any time the helicopter is not flying. This is particularly helpful as it allows you to safely handle the helicopter, while the ESC is still armed, regardless of the throttle/collective stick and Flight Mode switch positions.

**Note:** If the Throttle Hold switch is in the on position, and the throttle/collective stick set to anything above the lowest possible position with the Flight Mode switch set to the Normal position, the ESC/motor will power up as soon as the Throttle Hold switch is set to the off position. This is also the case regardless of the throttle/collective stick position when the Flight Mode switch is set to the Stunt position. You must exercise extreme care and caution when switching the Throttle Hold switch to the off position. You should always be in the Normal flight mode and have the throttle/collective stick set to the lowest possible position BEFORE switching Throttle Hold off.

---

## Before the First Flight

---

Although each Blade 400 3D model is factory assembled and tested, you should check the following before making your first flight:

- ❑ Check the security of all screws and control/linkage balls on your model. Tighten any screws and control/linkage balls that may be loose and replace any screws, control/linkage balls or other parts that may be stripped.
- ❑ Check to be sure that the screws securing the main and tail rotor blades in the blade grips are tightened so that the blades can pivot in the grips when moderate pressure is applied.
- ❑ Check the security of all the plastic ball link ends on your model. The links should stay attached to the control/linkage balls even when moderate force is applied. Any link that does not stay attached to the control/linkage ball should be replaced before flight.
- ❑ Check to be sure that all electronic equipment and wire leads are secure and will not come into contact with any moving parts.
- ❑ Check for proper tail rotor drive belt tension. Proper belt tension plays a critical role in achieving maximum performance and reliability of your model.

If the belt tension is set too tight, it can result in a loss of power while also causing the belt and/or pulleys to wear more quickly.

If the belt tension is set too loose, the belt can skip and strip teeth from the belt and/or pulleys. It can also result in a loss of tail rotor performance and control in flight.

You can check the tension of the tail rotor drive belt by using an Allen/hex wrench (or any other suitable tool/device) to compress the belt through the opening in the main frame and tail boom located on the right side of the model. Apply light pressure to the exposed side of the belt, compressing it toward the other side of the belt. The belt tension is set properly if the compressed side of the belt reaches approximately  $\frac{1}{2}$  of the way to the other side of the belt.

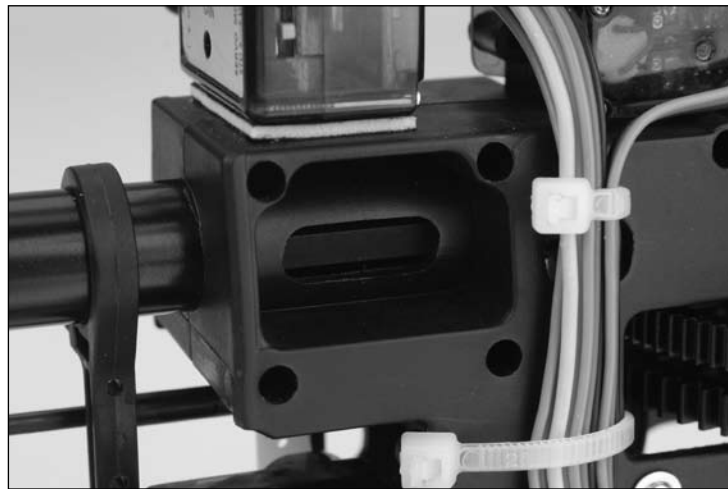

If the compressed side of the belt reaches more than  $\frac{1}{2}$  of the way to the other side of the belt, the tension is set too loose. If it is difficult to compress the exposed side of the belt, or if it does not reach approximately  $\frac{1}{2}$  of the way to the other side of the belt, the tension is set too tight.

You can adjust the belt tension by loosening the two screws that mount the horizontal stabilizer and the four screws that hold the rear section of the main frame together around the tail boom. After loosening these six screws, slide the boom further into the frame (to loosen belt tension) or farther out of the frame (to tighten belt tension). After properly adjusting the tail drive belt tension, be sure to retighten all six screws while also confirming proper alignment of the horizontal stabilizer and tail rotor shaft (both should be level/horizontal and perpendicular to the main shaft when viewed from behind the model).

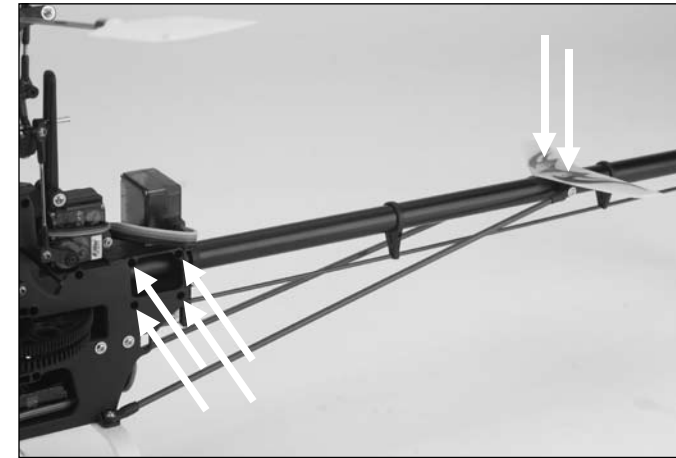

- ❑ If this is the first test flight, or a test flight following repairs, you will also want to center the rudder, aileron and elevator trims.

Your Blade 400 3D is now ready for flight.

---

## Choosing a Flying Area

---

When you are ready for your first flight, you will want to select a large, open area that is free of people and obstructions. Until you have properly trimmed, adjusted and become familiar with the handling of the Blade 400 3D, we suggest that your first and subsequent test flights be made outdoors in low-wind conditions only.

While it is possible for the Blade 400 3D to be flown indoors, we suggest that it only be in a very large indoor facility such as a gym (with proper approval) that is also free of people and obstructions. The Blade 400 3D is not intended to be flown in small indoor areas or facilities where it may be possible to fly a micro coaxial helicopter like the Blade CX or Blade CX2, or a micro collective pitch helicopter like the Blade CP+ or Blade CP Pro.

---

## Flying the Blade 400 3D

---

Having followed the proper ESC and gyro arming and initialization procedures, confirmed proper control of the servos and motor, and found a suitable flying area, your Blade 400 3D is ready for flight.

- Slowly raise the throttle/collective pitch (left-hand) stick, increasing the speed of the main rotor blades until the model begins to lift off. Do not raise the throttle stick too quickly as the model could climb too fast causing you to lose control or make contact with objects above.
- Lift the model off the ground just a few inches and concentrate on balancing the throttle stick position so that the model holds a steady hover altitude. In some cases it may be best to make a few short "hops" to an altitude of just a few inches until you become familiar with the control inputs and trim settings required to maintain a steady hover and altitude.

As you will find, the Blade 400 3D requires minor throttle/collective pitch adjustments to maintain its altitude in hover. Remember to keep these adjustments as minimal as possible as large adjustments could result in a loss of control and/or a possible crash.

- While attempting to establish a low-level hover, you can also check to see if any trim adjustments are required to help keep the Blade 400 3D from constantly drifting in various directions. If you find the helicopter constantly drifts without any directional control input, it will be best to land the model before making any adjustments to the trim levers. Additional details regarding the location and function of the trim levers can be found in the “Understanding the Primary Flight Controls” section of this manual.

If the nose of the helicopter is drifting to the left or right, you will need to adjust the rudder trim.

If the helicopter is drifting forward or backward, you will need to adjust the elevator trim.

If the helicopter is drifting to the left or right, you will need to adjust the aileron trim.

Continue to make trim adjustments until the helicopter can hover at a low altitude with very little drifting and directional control input.

- Once you have the Blade 400 3D properly trimmed and maintaining a stable low-level hover, practice using the rudder, elevator and aileron controls to get a feel for how the helicopter responds to control inputs. Remember to keep the control inputs as minimal as possible to prevent over-controlling the helicopter, especially when in hover.
- After becoming comfortable with hovering the Blade 400 3D at low-levels of altitude just a few inches off the ground, you can transition to hovering and flying the helicopter at higher altitudes of approximately three to four feet. At these higher altitudes you will be able to get a feel for the flight characteristics of the Blade 400 3D when it is flying out of “ground effect.”
- If at any time during flight you feel like the helicopter is drifting out of control, it is best to return all controls to neutral and to lower the throttle stick completely or activate Throttle Hold. This will help reduce the amount of damage that may be caused in the event of a crash.
- **IN THE UNFORTUNATE EVENT OF A CRASH OR ROTOR BLADE STRIKE, NO MATTER HOW MINOR OR MAJOR, YOU MUST LOWER THE THROTTLE (LEFT-HAND) STICK TO THE LOWEST POSSIBLE POSITION (WHEN IN THE NORMAL FLIGHT MODE ONLY) AS QUICKLY AS POSSIBLE TO PREVENT DAMAGE TO THE ESC. YOU CAN ALSO ACTIVATE THROTTLE HOLD IN ANY FLIGHT MODE, REGARDLESS OF THROTTLE STICK POSITION.**

Failure to lower the throttle stick to the lowest possible position (in the Normal Flight mode only) or to activate Throttle Hold (in any flight mode) in the event of a crash could result in damage to the ESC.

While the ESC is readily capable of handling all in-flight power loads, and even brief momentary bursts beyond these typical loads, it can be damaged if an excessive amount of current is pulled through it for an extended period of time. This period of time may vary depending on conditions, so it is best to keep any momentary overloads as short as possible in order to prevent damage to the ESC.

**Note: Crash damage is not covered under warranty.**

- It is extremely important when hovering and flying the Blade 400 3D to be aware of the power level of the Li-Po battery pack. If at any time the helicopter begins to require more throttle than typical to maintain hover or flight or has lost significant power, you must land the helicopter IMMEDIATELY to prevent a sudden loss in power that could result in a crash.

## Main Rotor Blade Tracking Adjustment

**Caution: Be sure to maintain a safe distance from the helicopter (10–15 feet) when tracking the main rotor blades.**

Blade tracking is a critical element to the flight performance of just about any helicopter, including the Blade 400 3D. Main rotor blades that are out of track may cause vibration, instability, and loss of power due to increased drag. Although the main rotor blades of each Blade 400 3D model are tracked at the factory, minor adjustments to blade tracking may be required after blade changes, linkage adjustments or repairs.

To check main rotor blade tracking and make any required adjustments, please note the following tips:

- Before proceeding with the test flight of a new model, or any model to which changes or repairs have been made, be certain that the main rotor blades have been properly installed and secured. The main rotor blade mounting bolts should be tightened so the blades can pivot in the blade grip when moderate pressure is applied. Never allow the main rotor blades to swing freely in their grips.
- After powering the model on and allowing the ESC and gyro to properly arm and initialize, bring the main rotor blades of your Blade 400 3D up to speed. You can check the blade tracking either on the ground or in the air at approximately eye level. It might be a good idea to have an assistant on hand to help sight the blades. Again, be certain to maintain a safe distance of 10–15 feet from the helicopter when checking the tracking of the main rotor blades.
- Once the main rotor blades have been brought up to speed, note which blade is running low and which blade is running high (by the colored tracking tape).

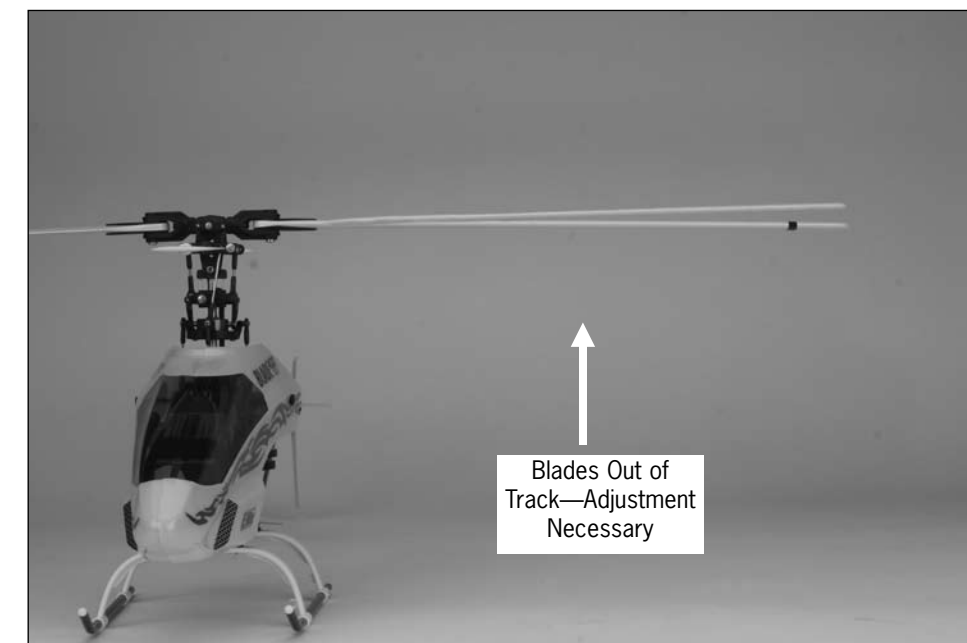

- After confirming which blade is running low and which blade is running high, power down the helicopter in order to make any necessary adjustments to the linkages. You can increase the pitch of the low blade by shortening the “mixing arm to inner swashplate linkage.” This is accomplished by turning one of the Ball Link ends in by one-half to one full turn at a time. Or, you can decrease the pitch of the high blade by lengthening the same linkage.

**Note:** The blade you choose to raise or lower when making tracking adjustments will depend on the pitch of each blade. Because both rotor blades should be as close to 0 degrees as possible when Throttle Hold is activated (DO NOT attempt to check for 0 pitch in the Normal or Stunt/Idle Up flight modes) and the throttle/collective stick is in the middle position, you can easily identify which rotor blade to adjust. If one blade is “lower” than 0 degrees, raise it to match the other blade. If one blade is “higher” than 0 degrees, lower it to match the other blade.

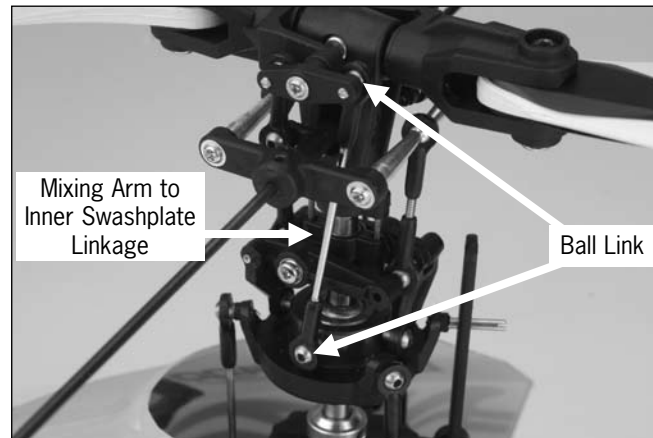

Typically, not much adjustment should be necessary to properly track the main rotor blades. If significant adjustments are required, be sure to double-check the length of both mixing arm to inner swashplate linkages (they should be close to the same length). You should also check the blades for any warps or twists. In most cases, you should be able to get both blades tracking perfectly in the same plane. However, due to slight variations in the ball links and threaded linkage rods/pushrods it may not always be possible to achieve absolutely perfect blade tracking. Don't worry, as the helicopter should still perform well as long as the blade tracking is adjusted as closely as possible.

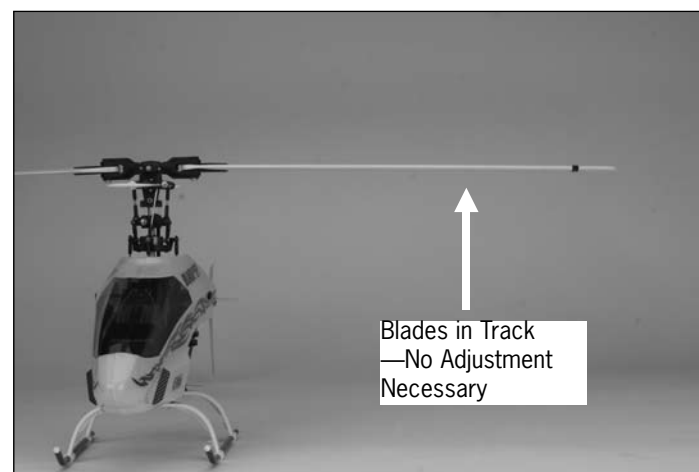

## Flybar Paddle Tracking Adjustment

While main rotor blade tracking is a critical element of flight performance, proper flybar paddle tracking and positioning is also important in maintaining proper control response and vibration-free operation.

To check flybar paddle tracking, positioning and to make any necessary adjustments, please note the following tips:

- Confirm that both flybar paddles are equally spaced from the ends of the flybar paddle control frame arms. If they are not equally spaced, adjust the position of the flybar by loosening the two setscrews located in each paddle control frame arm, then sliding the flybar from side to side until they are.
- Confirm that both flybar paddle control frame arms and rods are parallel to one another. It may be necessary to loosen the four screws that hold the paddle control frame assembly together in order to adjust the position of each part.
- Be certain that both flybar paddles are parallel to the flybar paddle control frame arms. If they are not, loosen the setscrews in the flybar paddle mounts/adapters and twist the paddles until they are properly aligned and parallel with the paddle control frame arms.
- If you have made certain that both flybar paddles are parallel to the paddle control frame arms, they should now be parallel to one another. If they are not, take your time making adjustments in order to ensure that both flybar paddles are positioned parallel to one another and the paddle control frame arms.



- Once you have properly positioned and aligned the flybar paddle control frame parts and the flybar paddles following the tips above, be certain that all screws and setscrews are firmly secured.

---

## Head Dampening Shims and Tuning Cyclic Response

---

The rotor head (main rotor blade) dampening of your Blade 400 3D model can be adjusted in order to tune the cyclic response and stability of your model. In general, stiffer dampening will result in quicker cyclic response with a slight reduction in stability (when compared to softer/less-stiff dampening). The dampening of your Blade 400 3D model has been set to provide a good balance of cyclic response and stability right out of the box, and we suggest that you make your first flights with this amount of dampening before making any changes.

If, after the first few flights, you would prefer to have even quicker and more aggressive cyclic response, you can stiffen the rotor head dampening by adding shims (in addition to the shims that were factory-installed) between the O-Ring (025) and Step Washer (020) on each side of the Head Block/Rotor Housing (see the "Exploded View Parts Listing" and "Exploded View Drawing" pages for reference). Head Dampening Shims are available separately in packs of eight (EFLH1144), however, you should add only one shim per side at a time before making each subsequent test flight, until you find the dampening at which you prefer the cyclic response (and stability) most.

**Note: You must always install an equal number of shims on each side of the Head Block/Rotor Housing.**

**Note: If you install too many shims, and the dampening becomes too stiff, the helicopter can wobble and shake in flight. Take care when making test flights after adding shims to prevent crashing the model as a result of a wobble or shake. Typically, we find that adding an additional 1–2 shims per side with the stock power system works well for more aggressive pilots and 3D flying. Adding too many additional shims per side can cause the model to wobble and shake. Again, exercise extreme care when test flying the model after adding any number of shims.**

Other options for tuning the cyclic response of your model include adjusting the aileron and elevator Swashplate Mixing (SWASH MIX), Dual Rate (D/R) and Exponential (EXPO) values in the transmitter (please see the manual for the DX6i for more information), as well as the installation of different length flybars and different weight flybar paddles (please see your favorite retailer or visit our web site for more information).

---

## Recommended Maintenance

---

Routine maintenance is necessary to keep your Blade 400 3D in optimal and safe flying condition. Some of the most important things to check routinely include:

- **Ball Links**  
Before each flying session, check to see that the plastic ball link ends are secure, but not tight (binding), on the linkage/control balls. The plastic ball links can wear over time, and if they become too loose on the control balls, they can separate from the ball in flight and cause a crash. Be sure to replace any worn ball links before they fail.  
  
Also, any ball links that are tight (binding) on the linkage/control balls can be loosened by carefully squeezing the sides of the link with a pair of pliers. However, exercise extreme care when "sizing" the ball links as it is possible to loosen them too much for safe use.
- **Bearings**  
The one-way bearing in the main drive gear should be cleaned using isopropyl alcohol or electric motor spray, then lubed with lightweight oil, approximately every 80 to 100 flights. All other bearings typically exhibit very long life and normally only need to be replaced if they ever become notchy (sticky in places when turning) or draggy.
- **Oiling**  
It's important to apply a small amount of lightweight oil (like TRI4026) to any areas where a bushing

may ride on a shaft, especially after replacing any of the parts with new ones after a crash. Some areas to oil include where the washout base bushing and swashplate control ball ride on the main shaft, and where the tail rotor control pitch slider bushing rides on the tail rotor shaft.

- **O-Ring Head Dampeners**  
The O-ring dampeners in the head block will periodically wear and lose their elasticity. Worn O-rings can cause main rotor blade tracking problems as well as stability and control response issues. If you begin having trouble with the blades going in and out of track during flight, or if the helicopter feels loose and "mushy" during flight, it is likely time to replace the O-ring dampeners. The O-ring dampeners can wear out in approximately 30 to 60 flights depending on how the model is flown.

Also, when replacing the O-ring dampeners, it's important to lubricate them with grease or petroleum jelly to prevent friction.

- **Tail Rotor Drive Belt**  
It's typical for the tail drive belt to stretch slightly over the first few flights. When new, frequently check and adjust the belt tension as required. After approximately 20 to 40 flights, the belt elasticity will stabilize, requiring little to no additional tension adjustment.

---

## 2007 Official AMA National Model Aircraft Safety Code

---

### GENERAL

- 1) I will not fly my model aircraft in sanctioned events, air shows or model flying demonstrations until it has been proven to be airworthy by having been previously, successfully flight tested.
- 2) I will not fly my model higher than approximately 400 feet within 3 miles of an airport without notifying the airport operator. I will give right-of-way and avoid flying in the proximity of full-scale aircraft. Where necessary, an observer shall be utilized to supervise flying to avoid having models fly in the proximity of full-scale aircraft.
- 3) Where established, I will abide by the safety rules for the flying site I use, and I will not willfully or deliberately fly my models in a careless, reckless and/or dangerous manner.
- 4) The maximum takeoff weight of a model is 55 pounds, except models flown under Experimental Aircraft rules.
- 5) I will not fly my model unless it is identified with my name and address or AMA number on or in the model. (This does not apply to models while being flown indoors.)
- 6) I will not operate models with metal-bladed propellers or with gaseous boosts, in which gases other than air enter their internal combustion engine(s); nor will I operate models with extremely hazardous fuels such as those containing tetranitromethane or hydrazine.

### RADIO CONTROL

- 1) I will have completed a successful radio equipment ground range check before the first flight of a new or repaired model.
- 2) I will not fly my model aircraft in the presence of spectators until I become a qualified flier, unless assisted by an experienced helper.
- 3) At all flying sites a straight or curved line(s) must be established in front of which all flying takes place with the other side for spectators. Only personnel involved with flying the aircraft are allowed at or in front of the flight line. Intentional flying behind the flight line is prohibited.
- 4) I will operate my model using only radio control frequencies currently allowed by the Federal Communications Commission. (Only properly licensed Amateurs are authorized to operate equipment on Amateur Band frequencies.)
- 5) Flying sites separated by three miles or more are considered safe from site-to site interference, even when both sites use the same frequencies. Any circumstances under three miles separation require a frequency management arrangement, which may be either an allocation of specific frequencies for each site or testing to determine that freedom from interference exists. Allocation plans or interference test reports shall be signed by the parties involved and provided to AMA Headquarters. Documents of agreement and reports may exist between (1) two or more AMA Chartered Clubs, (2) AMA clubs and individual AMA members not associated with AMA Clubs, or (3) two or more individual AMA members.
- 6) For Combat, distance between combat engagement line and spectator line will be 500 feet per cubic inch of engine displacement. (Example: .40 engine = 200 feet.); electric motors will be based on equivalent combustion engine size. Additional safety requirements will be per the RC Combat section of the current Competition Regulations.
- 7) At air shows or model flying demonstrations, a single straight line must be established, one side of which is for flying, with the other side for spectators.
- 8) With the exception of events flown under AMA Competition rules, after launch, except for pilots or helpers being used, no powered model may be flown closer than 25 feet to any person.
- 9) Under no circumstances may a pilot or other person touch a powered model in flight.

## Exploded View Parts Listing

Exploded View Reference Number	Description (Quantity Required)	Included In Item Number	Exploded View Reference Number	Description (Quantity Required)	Included In Item Number
001	Flybar Paddle (2)	EFLH1428	069	Motor Mount (1)	EFLH1443
002	Flybar Paddle Mount/Adapter (2)	EFLH1427	070	One-Way Bearing (1)	EFLH1450
003	Flybar (1)	EFLH1425	071	Socket Head Button Screw M3x8mm (2)	EFLH1473
004	Screw M2x6mm (4)	EFLH1473	072	Main Gear (1)	EFLH1451
005	Flybar Paddle Control Frame Arm (2)	EFLH1424	073	Washer/Shim 6x10x1mm (1)	EFLH1449
006	Bell Mixer Pushrod/Link (2)	EFLH1419	074	Socket Head Cap Screw M2x12mm (2)	EFLH1473
007	Spindle Brushing (1)	EFLH1422	075	Main Tail Drive Gear (1)	EFLH1453
008	Head Block/Rotor Housing (1)	EFLH1422	076	One-Way Bearing Shaft (1)	EFLH1449
009	Spindle/Feathering Shaft (1)	EFLH1421	077	Main Shaft Retaining Collar (1)	EFLH1448
010	Screw T1.7x3mm (2)	EFLH1473	078	Anti-Rotation Bracket/Guide (1)	EFLH1434
011	Screw T1.7x4mm (14)	EFLH1473	079	Tail Drive Shaft Lower Bearing Block/Mount (1)	EFLH1454
012	Bell Mixer Arm Brushing (2)	EFLH1418	080	Bearing 5x8x2.5mm (2)	EFLH1441
013	Bell Mixer Arm (2)	EFLH1418	081	One-Way Bearing Sleeve (1)	EFLH1451
014	Control/Linkage Ball, Short (20)	EFLH1436	082	Linkage Rod/Pushrod, 52mm (2)	EFLH1438
015	Main Rotor Blade Grip/Holder (2)	EFLH1417	083	Elevator Servo Arm (2)	EFLH1476
016	Bearing 3x6x2.5mm (10)	EFLH1115	084	Main Frame, Left (1)	EFLH1439
017	Thrust Bearing 3x8x3.5mm (2)	EFLH1420	085	Screw T2x8mm (2)	EFLH1473
018	Washer 2x5x2.5mm (7)	EFLH1473	086	Landing Skid End Cap (4)	EFLH1446B
019	Main Rotor Blade (2)	EFLH1415A	087	Screw T1.7x4mm (2)	EFLH1473
020	Step Washer 2x3x2mm (2)	EFLH1473	088	Landing Gear Strut (2)	EFLH1445W
021	Flybar Seesaw Holder (1)	EFLH1423	089	Landing Skid (2)	EFLH1446B
022	Flybar Paddle Control Frame Rod (2)	EFLH1424	090	Spacer 3x4x2.5mm (1)	EFLH1455
023	Ball Link (19)	EFLH1437	091	Tail Drive Pulley Cap (1)	EFLH1455
024	Washer 3x5.5x0.55mm (2)	EFLH1473	092	Tail Drive Pulley (1)	EFLH1455
025	O-Ring (2)	EFLH1158	093	Tail Drive Gear/Pulley Shaft (1)	EFLH1455
026	Socket Head Button Screw M3x16mm (2)	EFLH1416	094	Secondary Tail Drive Gear (1)	EFLH1455
027	Washer/Shim 5x8x0.1mm (2)	EFLH1420	095	Spacer 3x4x3.1 (1)	EFLH1455
028	Socket Head Cap Screw M2x6mm (2)	EFLH1473	096	Tail Linkage/Pushrod Joiner (1)	EFLH1459
029	Nylon Insert Lock Nut M3 (2)	EFLH1416	097	Tail Linkage/Pushrod (1)	EFLH1459
030	Screw M2x10mm (5)	EFLH1473	098	Tail Linkage/Pushrod Ball Link (1)	EFLH1459
031	Washout Control Arm (2)	EFLH1431	099	Linkage Rod/Pushrod, 38mm (1)	EFLH1438
032	Pin 1.5x8mm (2)	EFLH1431	100	Elevator Control Lever Arm (1)	EFLH1440
033	Washout Control Arm Link (2)	EFLH1431	101	Screw T1.7x9mm (21)	EFLH1473
034	Nut M2 (2)	EFLH1473	102	Tail Servo Boom Mount (1)	EFLH1458
035	Washout Base Guide Pin (2)	EFLH1422	103	Tail Boom (1)	EFLH1457
036	Washout Base Bushing (1)	EFLH1430	104	Tail Drive Belt (1)	EFLH1456
037	Washout Base	EFLH1430	105	Tail Pushrod Support/Guide, Long (1)	EFLH1460
038	Control/Linkage Ball, Short w/Long Thread (2)	EFLH1431	106	Screw T1.4x5mm (2)	EFLH1473
040	Linkage Rod/Pushrod, 16mm (3)	EFLH1438	107	Horizontal Stabilizer/Fin Mount (1)	EFLH1462
041	Setscrew M3x3 (9)	EFLH1473	108	Horizontal Stabilizer/Fin (1)	EFLH1472Y
042	Linkage Rod/Pushrod, 45mm (2)	EFLH1438	109	Tail Rotor Pitch Control Slider Bushing (1)	EFLH1468
043	Swashplate Control Ball Bushing (1)	EFLH1433	110	Pin 1.5x5mm (2)	EFLH1468
044	Swashplate Control Ball (1)	EFLH1433	111	Bearing 4x7x2.5mm (2)	EFLH1468
045	Control/Linkage Ball, Long (4)	EFLH1435	112	Tail Rotor Pitch Control Slider Ring (1)	EFLH1468
046	Inner/Upper Swashplate Ring (1)	EFLH1433	113	Socket Head Cap Screw M2x14mm (1)	EFLH1473
047	Anti-Rotation Pin (1)	EFLH1433	114	Tail Pushrod Support/Guide, Short (1)	EFLH1460
048	Outer/Lower Swashplate Ring (1)	EFLH1433	115	Tail Rotor Blade Grip/Holder (2)	EFLH1470
049	Bearing 17x23x4mm (1)	EFLH1433	116	Aluminum Tail Rotor Hub (1)	EFLH1469
050	Main Shaft (1)	EFLH1447	117	Bearing 2x6x3mm (4)	EFLH1121
051	Tail Boom Brace/Support End, Straight (2)	EFLH1461	118	Socket Head Cap Screw M2x7mm (3)	EFLH1473
052	Tail Boom Brace/Support Rod (2)	EFLH1461	119	Tail Rotor Blade (2)	EFLH1471
053	Screw T2x6mm (11)	EFLH1473	120	Tail Rotor Pitch Control Ball Link (2)	EFLH1468
054	DS75H Digital Sub-Micro Heli Servo (4)	EFLRDS75H	121	Tail Rotor Pitch Control Fork/Yoke (1)	EFLH1468
055	Aileron/Pitch Servo Arm (2)	EFLH1476	122	Spacer/Crush Sleeve 2x3x4.6mm (1)	EFLH1467
056	Linkage Rod/Pushrod, 26mm (1)	EFLH1438	123	Specialty Pin Screw T2.3x4mm (2)	EFLH1467
057	Socket Head Button Screw M2.5x7mm (4)	EFLH1473	124	Tail Rotor Pitch Lever (1)	EFLH1467
058	Tail Boom Brace/Support End, Angled (2)	EFLH1461	125	Tail Case, Right (1)	EFLH1463
059	Cap Washer (4)	EFLH1443	126	Tail Rotor Shaft (1)	EFLH1465
060	Main Frame, Right (1)	EFLH1439	127	Tail Drive Belt Guide Pulley/Tensioner (1)	EFLH1464
061	Canopy Mount Grommet (2)	EFLH1479	128	Bearing 2x5x2.5mm (1)	EFLH1464
062	Body/Canopy (1)	EFLH1481	129	Tail Rotor Shaft Drive Pulley (1)	EFLH1465
063	420H Brushless Motor (1)	EFLM1350H	130	Tail Rotor Shaft Drive Pulley Cap (1)	EFLH1465
064	Linkage Rod/Pushrod, 32mm (1)	EFLH1438	131	Spacer 3x4x3.5mm (1)	EFLH1465
065	10-Tooth Pinion Gear (1)	EFLH1410	132	Tail Case, Left (1)	EFLH1463
066	Bearing 5x10x4mm (3)	EFLH1442	133	Vertical Stabilizer/Fin (1)	EFLH1472Y
067	Canopy Mount Rod (1)	EFLH1479	134	Screw M2x14mm (2)	EFLH1473
068	Elevator Control Lever (1)	EFLH1440			

## Exploded View

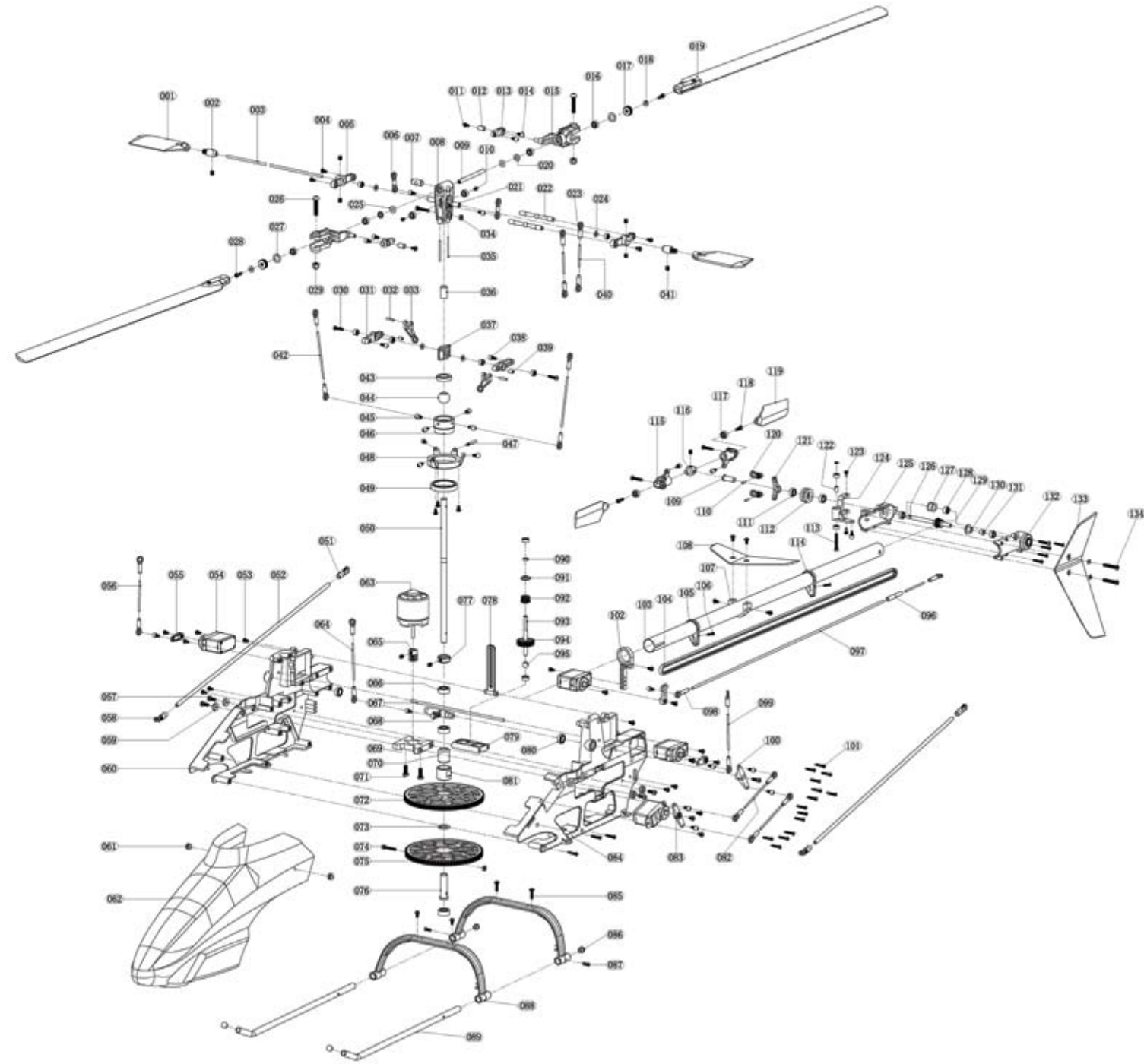

Please see your favorite retailer or visit our web site ([www.E-fliteRC.com](http://www.E-fliteRC.com)) to find the latest in new replacement and option parts releases for your Blade 400 3D.

## Replacement Parts List

EFLA325H.....	25-Amp Helicopter Brushless ESC	EFLH1440.....	Elevator Control Lever Set: B400
EFLB18003S.....	1800mAh 3S 11.1V 20C Li-Po, 13GA EC3	EFLH1441.....	Bearing 5x8x2.5mm (2): B400
EFLC3115.....	3S 11.1V Li-Po Balancing Charger, 1.8A	EFLH1442.....	Bearing 5x10x4mm (2): B400
EFLM1350H.....	Brushless 420 Helicopter Motor, 3800Kv	EFLH1443.....	Aluminum Motor Mount Set: B400
EFLRDS75H.....	7.5 Gram DS75 Digital Sub-Micro Helicopter Servo	EFLH1444.....	Hook and Loop Battery Strap: B400
EFLRDS751.....	Gear Set: DS75	EFLH1445W.....	Landing Gear Strut Set, White: B400
EFLRS752.....	Case Set: S75, DS75	EFLH1446B.....	Landing Gear Skid Set, Black: B400
EFLRSA100.....	Standard Arm Set, Fine Spline: S60,DS75	EFLH1447.....	Main Shaft (2): B400
EFLRG110HL.....	11.0 Gram G110 Micro Heading Lock Gyro	EFLH1448.....	Main Shaft Retaining Collar: B400
SPM6600.....	DX6i 6-Channel Full Range System w/o Servos MD2	EFLH1449.....	One-Way Bearing Shaft and Shim Set: B400
SPMAR6100E...	AR6100 DSM2 ML 6-Channel Receiver End-Pin	EFLH1450.....	One-Way Bearing 6x10x12mm: B400
EFLH1001.....	Mini Helicopter Main Blade Holder: B400	EFLH1451.....	Main Gear w/o One-Way Bearing: B400
EFLH1115.....	Bearing 3x6x2.5mm (2): BCP, BCPP, B400	EFLH1452.....	Main Gear w/One-Way Bearing: B400
EFLH1121.....	Bearing 2x6x3mm (2):BCP, BCPP, BCX, BCX2, B400	EFLH1453.....	Main Tail Drive Gear: B400
EFLH1144.....	Head Dampening Shims (8): BCP, BCPP, B400	EFLH1454.....	Tail Drive Shaft Lower Bearing Block/Mount: B400
EFLH1400.....	Blade 400 3D RTF Electric Mini Helicopter	EFLH1455.....	Tail Drive Gear/Pulley Assembly: B400
EFLH1410.....	Pinion Gear, 10T 0.5M: B400	EFLH1456.....	Tail Drive Belt: B400
EFLH1415A.....	325mm Wood Main Rotor Blade Set, White: B400	EFLH1457.....	Tail Boom (2): B400
EFLH1416.....	Main Rotor Blade Mounting Screw and Nut Set: B400	EFLH1458.....	Tail Servo Boom Mount: B400
EFLH1417.....	Main Rotor Blade Grip/Holder Set: B400	EFLH1419.....	Bell Mixer Pushrod/Link (2): B400
EFLH1418.....	Bell Mixer Arm and Pushrod/Link Set: B400	EFLH1459.....	Tail Linkage/Pushrod Set: B400
EFLH1419.....	Bell Mixer Pushrod/Link (2): B400	EFLH1460.....	Tail Pushrod Support/Guide Set: B400
EFLH1420.....	Thrust Bearing 3x8x3.5mm (2): B400	EFLH1461.....	Tail Boom Brace/Support Set: B400
EFLH1421.....	Spindle/Feathering Shaft (2): B400	EFLH1462.....	Horizontal Stabilizer/Fin Mount: B400
EFLH1422.....	Head Block/Rotor Housing Set: B400	EFLH1463.....	Tail Case Set: B400
EFLH1423.....	Flybar Seesaw Holder Set: B400	EFLH1464.....	Tail Drive Belt Guide Pulley/Tensioner: B400
EFLH1424.....	Flybar Paddle Control Frame Set: B400	EFLH1465.....	Tail Rotor Shaft and Drive Pulley (2): B400
EFLH1425.....	Flybar, 220mm (2): B400	EFLH1466.....	Bearing 2x5x2.5mm (2): B400
EFLH1427.....	Flybar Paddle Mounts/Adapters: B400	EFLH1467.....	Tail Rotor Pitch Lever Set: B400
EFLH1428.....	Flybar Paddle Set for Mounts/Adapters: B400	EFLH1468.....	Tail Rotor Pitch Control Slider Set: B400
EFLH1430.....	Washout Base: B400	EFLH1469.....	Aluminum Tail Rotor Hub Set: B400
EFLH1431.....	Washout Control Arm and Link Set: B400	EFLH1470.....	Tail Rotor Blade Grip/Holder Set: B400
EFLH1432.....	Washout Control Arm Link Set: B400	EFLH1471.....	Tail Rotor Blade Set: B400
EFLH1433.....	Aluminum and Composite Swashplate: B400	EFLH1472Y.....	Stabilizer/Fin Set, Yellow: B400
EFLH1434.....	Anti-Rotation Bracket/Guide: B400	EFLH1473.....	Complete Hardware Set: B400
EFLH1435.....	Control/Linkage Ball, Long (4): B400	EFLH1474.....	Mounting Accy,Screwdriver & Wrench Set: B400
EFLH1436.....	Control/Linkage Ball, Short (10): B400	EFLH1476.....	Servo Arm Set, DS75/DS75H: B400
EFLH1437.....	Ball Link Set (20): B400	EFLH1479.....	Canopy Mount Rod & Grommet Set: B400
EFLH1438.....	Linkage Rod/Pushrod Set: B400	EFLH1481.....	Body/Canopy, Tribal w/Decals: B400
EFLH1439.....	Main Frame Set: B400	EFLH1482.....	Decal Sheet, Tribal: B400

## Optional Parts List

EFLC4030.....	100-240V AC to 12V DC, 3.0-Amp Power Supply	EFLH1472B.....	Stabilizer/Fin Set, Blue: B400
EFLH1000.....	Micro/Mini Helicopter Pitch Gauge	EFLH1472C.....	Stabilizer/Fin Set, Carbon Fiber: B400
EFLH1409.....	Pinion Gear, 9T 0.5M: B400	EFLH1472W.....	Stabilizer/Fin Set, White: B400
EFLH1411.....	Pinion Gear, 11T 0.5M: B400	EFLH1480.....	Body/Canopy, White w/o Decals
EFLH1415C.....	325mm Carbon Fiber Main Rotor Blade Set: B400	EFLH1483.....	Body/Canopy, Flame
EFLH1429C.....	Flybar Paddle Set, Carbon Fiber: B400	EFLH1484.....	Decal Sheet, Flame: B400
EFLH1471C.....	Tail Rotor Blade Set, Carbon Fiber: B400		

## NOTES

Please see your favorite retailer or visit our web site ([www.E-fliteRC.com](http://www.E-fliteRC.com)) to find the latest in new replacement and option parts releases for your Blade 400 3D.





© 2007 Horizon Hobby, Inc.  
4105 Fieldstone Road  
Champaign, Illinois 61822  
(877) 504-0233  
[www.E-fliteRC.com](http://www.E-fliteRC.com)

Spektrum is used with permission of Bachmann Industries Inc., Spektrum radios and accessories are exclusively available from Horizon Hobby Inc.  
DSM and DSM2 are trademarks or registered trademarks of Horizon Hobby.