

DURATRAX

NITRO DEMON™



ASSEMBLY AND OPERATION MANUAL

Warranty

- DuraTrax® will warranty this kit for 90 days after the purchase date from defects in materials or workmanship. DuraTrax will either repair or replace, at no charge, the incorrectly made part.
- Make sure you **save the receipt or invoice** you were given when you bought your model! It is your proof of purchase and we must see it before we can honor the warranty.
- To return your Nitro Demon for repairs covered under warranty you should send your truck to:

Hobby Services
1610 Interstate Drive
Champaign, Illinois 61822
Attn: Service Department
Phone: (217) 398-0007 9:00 am - 5:00 pm Central Time M-F
E-mail: hobbyservices@hobbico.com

Before Building:

We want the building and operating of this vehicle to be a success, so **BEFORE** removing any parts from the parts bags please read this manual thoroughly and watch the included video to familiarize yourself with the model. If for any reason you think this model is not for you, return it to your dealer immediately. **PLEASE NOTE:** Your hobby dealer cannot accept a return on any model after assembly has begun.

TABLE OF CONTENTS

Introduction.....	2
Safety Precautions	2
Helpful Hints.....	2
Stress-Tech™ Parts Guarantee	2
Repair Service.....	3
Specification & Description Changes.....	3
Screw Information	3
Required Items for Completion	3
Tools You Will Need.....	3
FINISHING THE RTR VERSION.....	4
Antenna Installation	4
Air Filter Installation.....	4
Radio Setup.....	4
Body.....	5
ASSEMBLY OF THE PRE-BUILT VERSION.....	6
Preparing the Radio System	6
Radio Installation.....	6
Steering Linkage.....	10
Brake and Throttle Linkage	11
Air Filter and Fuel Tubing Installation	12
Radio Adjustments	13
Body.....	14
Carburetor Settings	14
Breaking in the Engine.....	15
Running the Engine.....	15
Engine Maintenance	16
Performance Tuning	17
Maintenance Tips.....	18
Engine Trouble Shooting	19

INTRODUCTION

Thank you for purchasing the DuraTrax Nitro Demon. This manual contains the instructions you need to build, operate and maintain your new nitro R/C stadium truck. Read over this manual thoroughly before building or operating the Nitro Demon.

SAFETY PRECAUTIONS

When the safety precautions are followed, the Nitro Demon will provide years of enjoyment. Use care and good sense at all times when operating this radio controlled stadium truck. Failure to use this vehicle in a safe, sensible manner can result in injury or damage to property. You and you alone must insure that the instructions are carefully followed and all safety precautions are obeyed.

- Do not operate the Nitro Demon near people. Spectators should be behind the driver or at a safe distance away from the vehicle.
- The engine and exhaust produces quite a bit of noise. If you are disturbed by the amount of noise this truck produces, wear ear protection such as earplugs. Do not run this vehicle when or where it can disturb others.

- The engine and exhaust can become very hot. Avoid touching any of these parts during use and until they have cooled down.
- Model engine fuel is poisonous. Make sure you read and follow all of the precautions on the fuel container. Keep fuel out of the reach of children.
- Model engine fuel is flammable and when ignited has a flame that is difficult to see. Avoid sparks, flames, smoking, or any other ignition source when fuel is near.
- The engine emits carbon dioxide just like real cars. Do not operate this model indoors.
- Before turning on the transmitter, make sure that no one else is on your frequency.

HELPFUL HINTS

- Avoid working over a deep pile carpet. If you drop a small part or screw, it will be difficult to find.
- Place a mat or towel over your work surface. This will prevent parts from rolling off and will protect the work surface.
- Avoid running the truck in cold weather. The plastic and metal parts can become brittle at low temperatures. In addition, grease and oil become thick, causing premature wear and poor performance.
- Test fit all parts before attaching them permanently.

STRESS-TECH™ PARTS GUARANTEE

We have engineered the Nitro Demon to take the rough and tumble abuse that makes R/C stadium trucks fun. We are so confident of the quality and durability of the Stress-Tech™ plastic parts that we will replace any Stress-Tech plastic part you break during the first 6 months you own the truck. Just send in the part to us and we will send you a **Free** replacement. Please see the Nitro Demon parts list for the items covered under the Stress-Tech guarantee.

To receive your free replacement part please send the following to the Hobby Services address listed on the cover of this manual:

- The broken part must be included.
- The part number and description of the broken part.
- Dated copy of your invoice or purchase receipt.
- Your name, phone number and shipping address.

REPAIR SERVICE

Repair service is available anytime.

- After the 90 day warranty, you can still have your Nitro Demon repaired for a small charge by the experts at DuraTrax's authorized repair facility, Hobby Services, at the address listed on the front page of this manual.

To speed up the repair process, please follow the instructions listed below.

1. Under most circumstances return the **ENTIRE** system: truck and radio. The exception would be sending in a Stress-Tech part. See the instructions under Stress-Tech Guarantee.
2. Make sure the transmitter is turned off, all batteries are removed and fuel is drained from the tank.
3. Send written instructions which include: a list of all items returned, a **THOROUGH** explanation of the problem, the service needed and your phone number during the day. If you expect the repair to be covered under warranty, be sure to include a proof of date of purchase (your store receipt or purchase invoice).
4. Also be sure to include your full return address.

SPECIFICATION & DESCRIPTION CHANGES

All pictures, descriptions and specifications found in this instruction manual are subject to change without notice. DuraTrax maintains no responsibility for inadvertent errors in this manual.

SCREW INFORMATION

Do not use too much force when tightening self-tapping screws into plastic. Overtightening will cause the threads in the plastic to strip. We recommend that you stop turning a self-tapping screw when you feel some resistance as the head of the screw comes in contact with the plastic. Avoid using powered screwdrivers when assembling this kit. They tend to overtighten the screws. Do not use thread locking compound on any self-tapping screws. The thread locking compound may damage the plastic. **IMPORTANT:** Use thread lock on any fastener that is threaded into metal or fastened with a nut. Vibration from the engine will cause the screws to loosen if thread locking compound is not used.

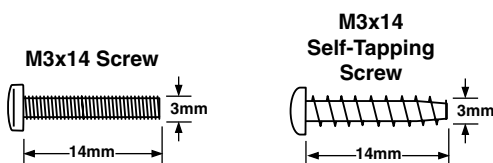

EQUIPMENT YOU WILL NEED

To operate the Nitro Demon RTR these items are required:

- Fuel (DuraTrax Red Alert fuel - DTXP0520)
- Air Filter Oil (DTXC2465)
- Glow plug wrench (DTXR1170)
- Hobby knife (HCAR0105), #11 blades (HCAR0211)
- It is also helpful to have a couple of extra glow plugs on hand (O.S. #A3 plug - OSMG2690)



DuraTrax Nitro Starter Pack from - DTXP0200

For the Pre-Built version of the Nitro Demon, you will also need:

- 2-channel radio with one (1) standard servo and one (1) high torque (70+ oz./in.) steering servo
- Twelve (12) "AA" batteries - Four (4) for the receiver and eight (8) for the transmitter
- Glow plug starter (DuraTrax Rapid Heat- DTXP3000)
- Fuel bottle (DuraTrax Kwik-Pit Bottle - DTXP0125)
- Small bottle of thread locking compound (GPMR6060)

TOOLS YOU WILL NEED

To assemble the Pre-built version (DTXC0075), you will need the following tools:

- #1 Phillips head screwdriver (DTXR0122)
- Flat blade screwdriver (DTXR0100)
- Needle-nose pliers (DTXR0300)
- Wire cutters or diagonal cutters (HCAR0630)
- Hobby knife (HCAR0105), #11 blades (HCAR0211)
- Drill with 1/4", 1/8", 5/64" (or 6mm, 3mm, 2mm) bits

FINISHING THE NITRO DEMON RTR VERSION (DTXD75**)

- ❑ 1. Remove the Nitro Demon, transmitter and parts from the box.

ANTENNA INSTALLATION

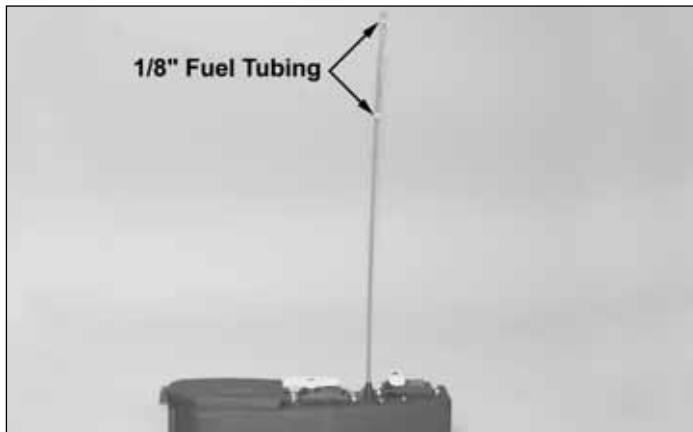

- ❑ 2. Remove the twist-tie from the receiver antenna wire. The receiver antenna wire is a bundled thin wire that is attached to the receiver. Run the length of the antenna wire through your fingers to help straighten the wire out, this will make it easier to insert the wire through the tube. Remove the antenna tube from the decal bag. Slide the receiver antenna wire through the antenna tube. **Do not coil or cut the antenna.** Cut two pieces of fuel tubing 1/8" wide and slide them over the outside of the antenna tube and wire. This is to help hold the antenna wire on and avoid getting the antenna wire cut in a roll over. Note the placement of the tubing on the antenna tube.

AIR FILTER INSTALLATION

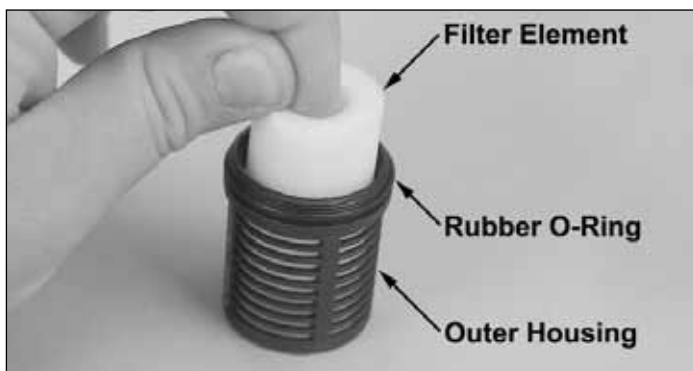

- ❑ 3. Remove the air filter parts from the parts pack. Slide the large rubber O-ring around the threads of the outer housing. The O-ring will help seal the air filter housing together. Soak the air cleaner element with an air filter oil, light machine oil, or, in a pinch, shock oil. Thoroughly soak the foam element and squeeze out the excess. Then install the filter element into the plastic outer housing.

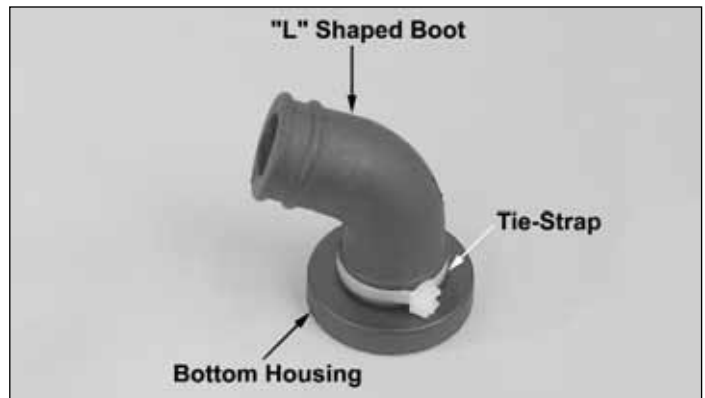

- ❑ 4. Press the "L" shaped boot onto the bottom housing of the air filter. Using one of the included tie-straps, tightly secure the boot onto the bottom housing. Cut off the excess portion of the tie-strap. Screw the bottom and outer filter housing together. **Note: Overtightening will strip the threads.**

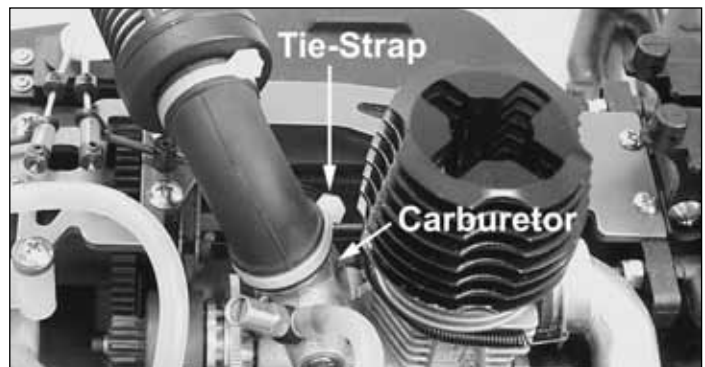

- ❑ 5. Place the air filter onto the carburetor. Using the remaining included tie-strap, tightly secure the air filter to the carburetor. Cut the excess portion of the tie-strap off to avoid interference.

RADIO SETUP

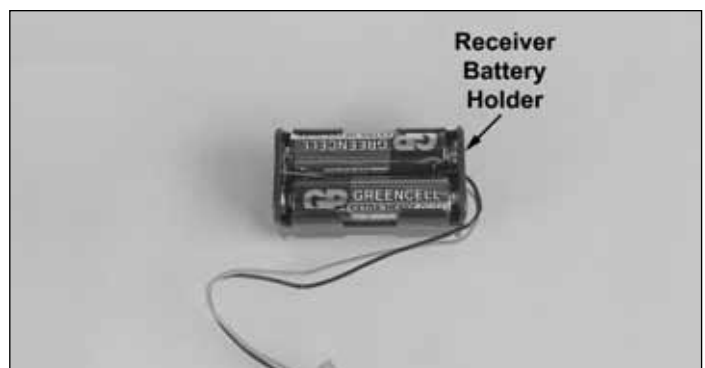

- ❑ 6. Remove the receiver battery holder from the radio box. Install (4) "AA" batteries (included) into the battery holder in the configuration molded into the battery holder.



❑ 7. Cut a piece of foam the size of the radio box and place it in the bottom for all of the equipment to set on. Re-install the receiver battery into the radio box. Note the placement of the receiver battery in the box. Make sure that the receiver switch is in the “off” position. Plug the connector on the receiver battery into the socket on the receiver switch. Wrap the receiver with the included foam rubber (if desired, secure with a rubber band, not included) to help reduce possible radio interference from vibration.

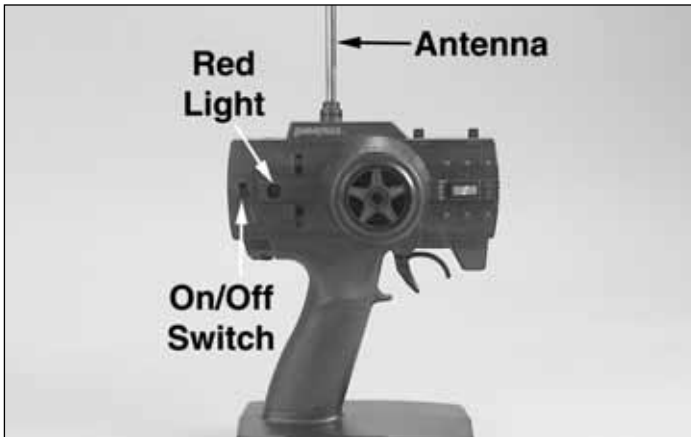

❑ 8. Remove the transmitter antenna from the holder and screw it into the hole on the top of the transmitter.



❑ 9. Slide open the battery door on the bottom of the transmitter. Place 8 “AA” batteries into the holder in the configuration molded into the plastic on the battery holder. Re-install the battery door.

❑ 10. Turn on the transmitter using the switch on the side (see photo step 9). The red light on the side of the transmitter should light up. If there is no light on, turn the transmitter off and check to ensure that the batteries are making contact with the metal contacts in the battery holder. Make sure the batteries are installed correctly. Turn the transmitter on and check for the red light. If the red light appears, turn off the transmitter. If the red light blinks, the batteries are low and should be replaced.

BODY

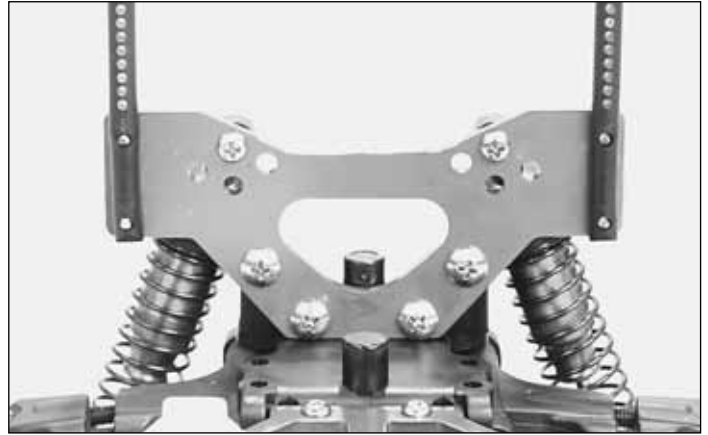

❑ 11. Remove the lower screw from each of the body posts so that the posts can be placed upright. Re-install the screw through the shock tower into the body post as shown.



❑ 12. Remove the plastic from the outside of the body. Apply the decals to the body if desired.

❑ 13. Remove the body clips from the parts bag. Insert a body clip through bottom hole on each body mount post. Place the body onto the body mounts and secure with body clips. You may choose to trim the body mounts shorter.

You are ready to go! Watch the video one more time and turn to page 14 to learn about tuning the engine, performance and maintenance tips.

ASSEMBLY OF THE NITRO DEMON PRE-BUILT VERSION (DTXC0075)

PREPARING THE RADIO SYSTEM

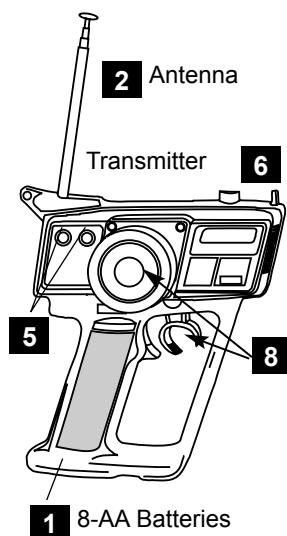

Before installing the radio system in the pre-built DuraTrax Nitro Demon read the manufacturer's instruction manual and follow the instructions shown below.

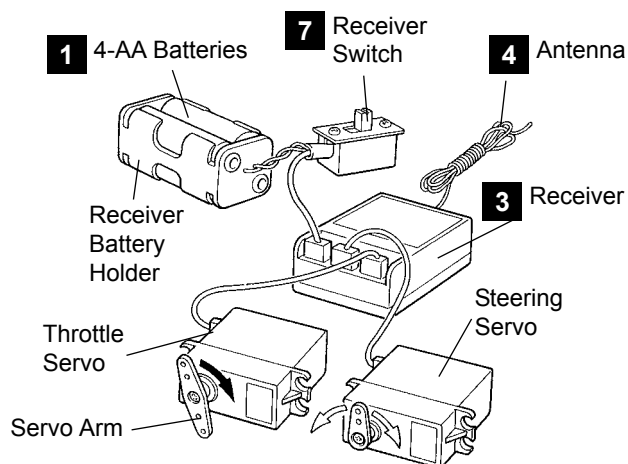

- ❑ 1. Install the "AA" batteries in the transmitter and the receiver holders.
- ❑ 2. Extend the transmitter antenna.
- ❑ 3. Connect the steering servo, throttle servo and switch to the receiver. Plug the receiver battery to the switch
- ❑ 4. Extend the receiver antenna.
- ❑ 5. Adjust the servo trims of the transmitter to the neutral position.
- ❑ 6. Switch on the transmitter.
- ❑ 7. Switch on the receiver.
- ❑ 8. Operate the steering and throttle control. Make sure the servo arms move in proportion to the movement of the steering wheel and throttle trigger.
- ❑ 9. Switch off the receiver, then the transmitter.

- ❑ 1. Remove the Nitro Demon stadium truck from the box.

RADIO INSTALLATION

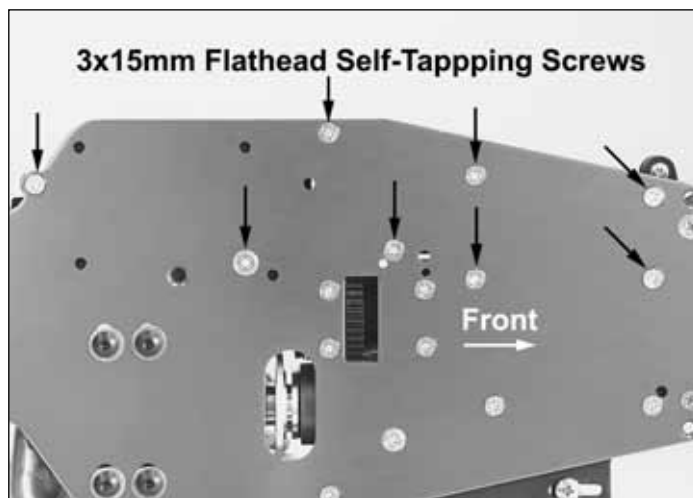

- ❑ 2. Remove the radio tray from the chassis by removing the (8) 3x15mm flat head self tapping screws from the bottom of the chassis.

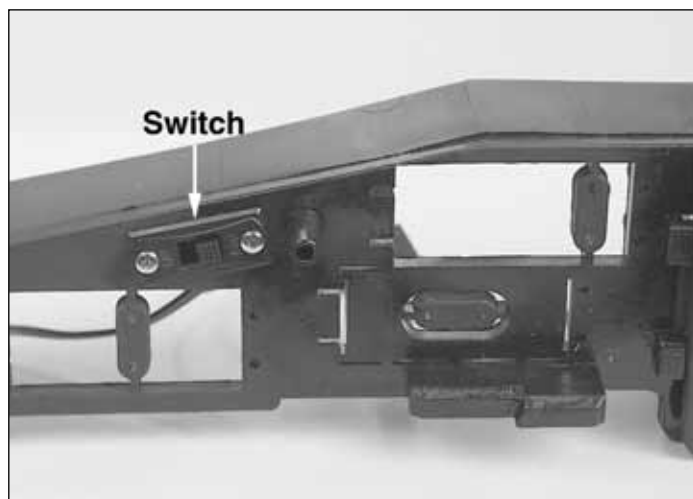

- ❑ 3. Install the receiver on/off switch. Remove the two screws from the face plate of the on/off switch and remove the face plate. The switch should be in the "OFF" position. Insert the on/off switch up through the bottom of the radio plate. Then place the face plate over the top of the on/off switch and place the two screws back through the face plate into the on/off switch. Be sure to reinstall the face plate with the "OFF" position next to the switch button. Run both wires from the on/off switch through the hole in the side of the radio box.

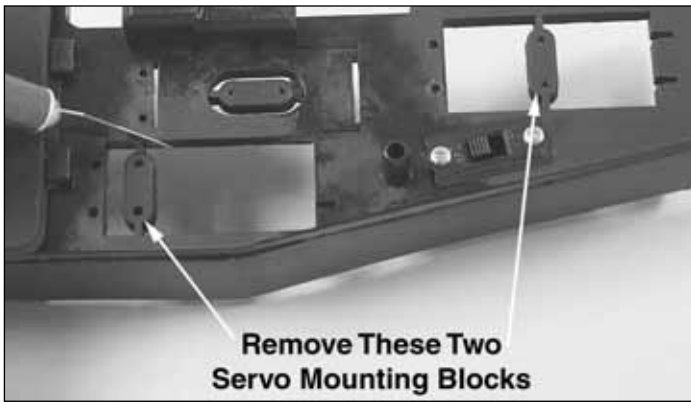

❑ 4. Use a hobby knife or diagonal cutters to remove the servo mounting blocks from the radio tray. Make sure all of the flashing is removed from inside the servo compartment to assure a proper servo fit. **Save the servo mounting blocks.**

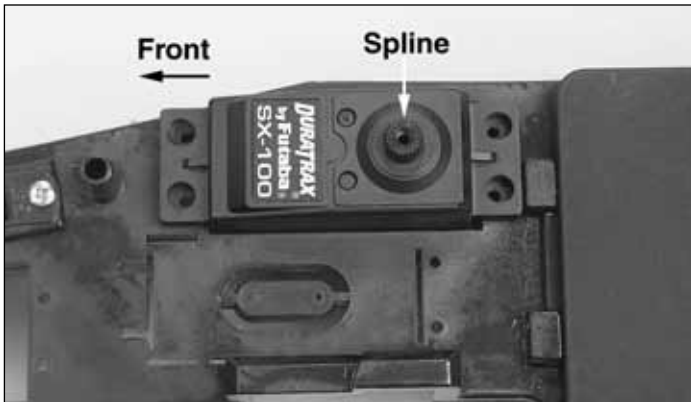

❑ 5. Place the standard throttle servo into the radio tray. **Note: Notice the direction of the servo spline when installing.** Run the servo lead into the radio box through the hole in the side.

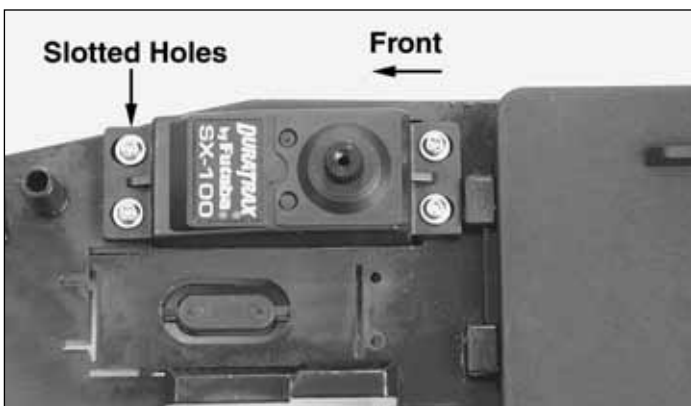

❑ 6. Mount the servo to the radio tray using four mounting screws included with the radio system. Use one of the servo mounting blocks that you cut out of the radio tray in step 4 and place it against the under side of the radio tray under the slotted holes. The screws should go through the servo, the radio tray and thread into the servo mounting block. **Note: Make sure to use the servo mounting block on the end with the slotted mounting holes.**

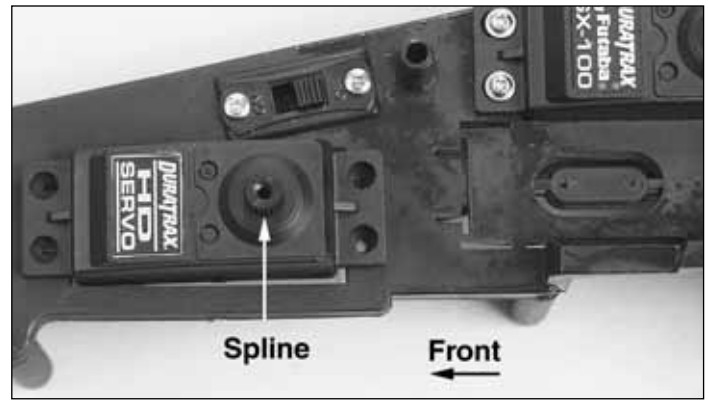

❑ 7. Place the high torque steering servo into the radio tray. **Note the direction of the servo spline when installing.** Run the servo lead through the hole in the side of the radio box.

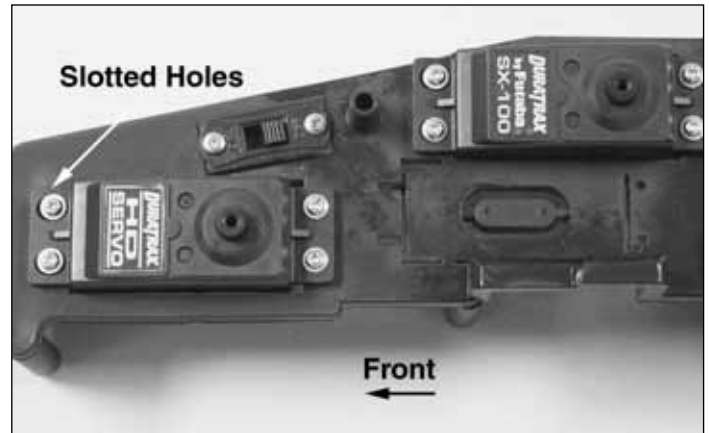

❑ 8. Mount the servo to the radio tray using four mounting screws included with the radio system. Use the other mounting block that you cut out of the radio tray in step 4 and place it against the under side of the radio tray under the slotted holes. The screws should go through the servo, the radio tray and into the servo mounting block. **Note: Make sure to use the mounting block on the end with the slotted mounting holes.**

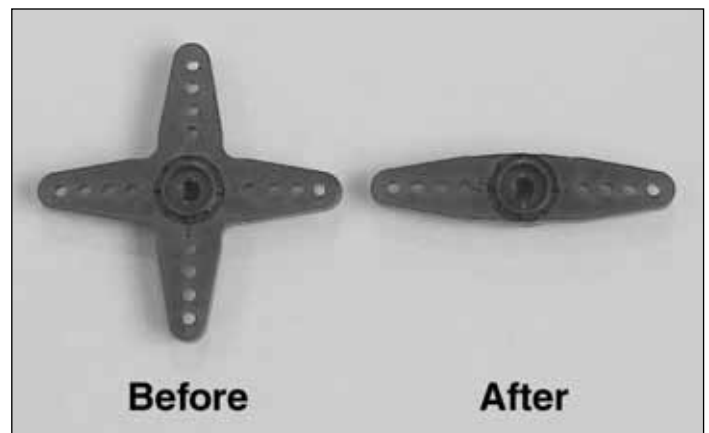

❑ 9. Cut two of the arms off the throttle servo horn by scoring both sides of the arm with a hobby knife and snapping off the arms with pliers.

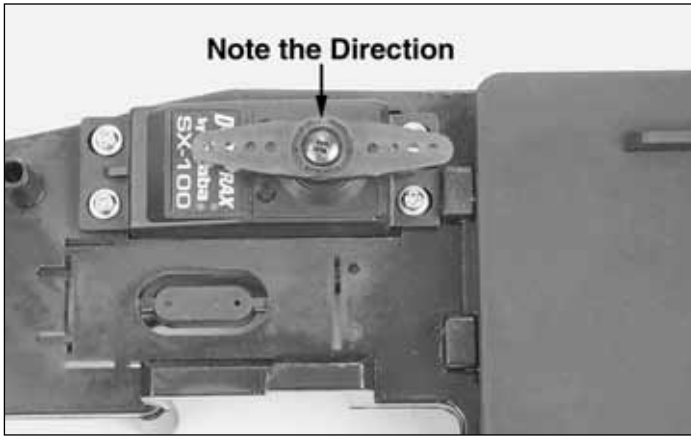

□ 10. Install the servo horn onto the throttle servo, **note the direction of the servo horn**. Secure the horn to the servo with the screw included with the radio system.

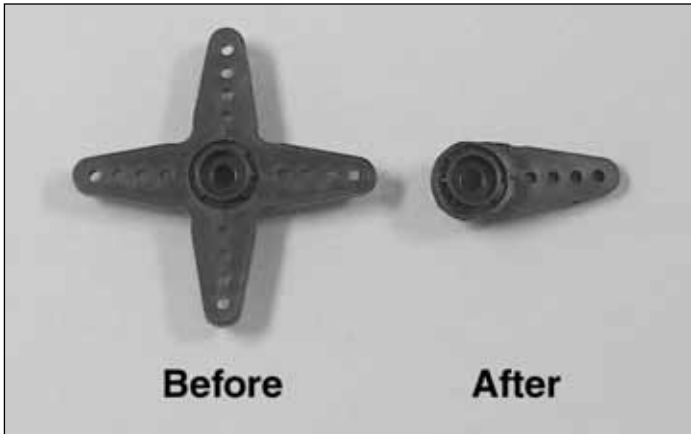

□ 11. Remove three of the arms off the steering servo horn as shown.

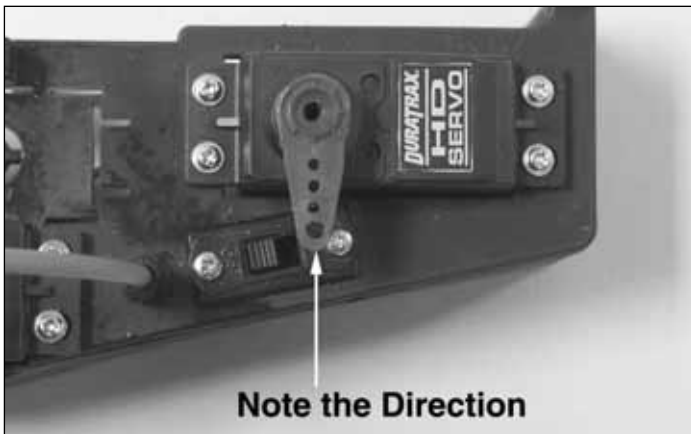

□ 12. Install the servo horn onto the steering servo, **note the direction of the servo horn**. Secure the horn to the servo with the screw included with the radio system.

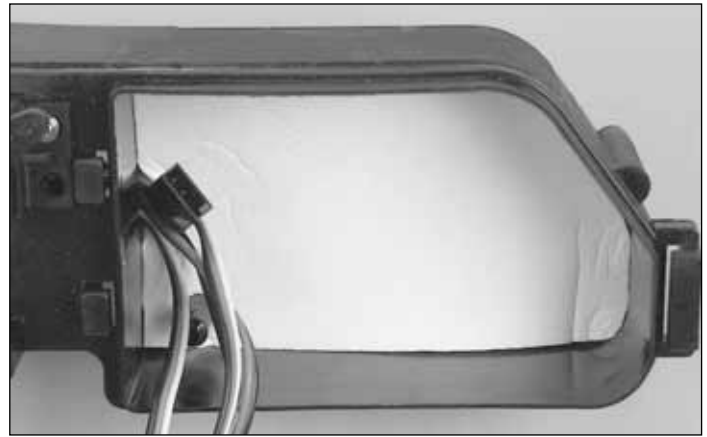

□ 13. Route the wires and connectors for the switch and two servos through the hole in the radio box. Cut a piece of foam the size of the radio box and place it in the bottom for all of the equipment to set on. Make sure that all of the wires coming into the radio box are on top of the foam. This is to help prevent vibration damage to the receiver.



□ 14. Install the receiver into the radio box and route the antenna wire through the same hole the servo leads come in. Run the antenna wire up through the antenna mount hole.

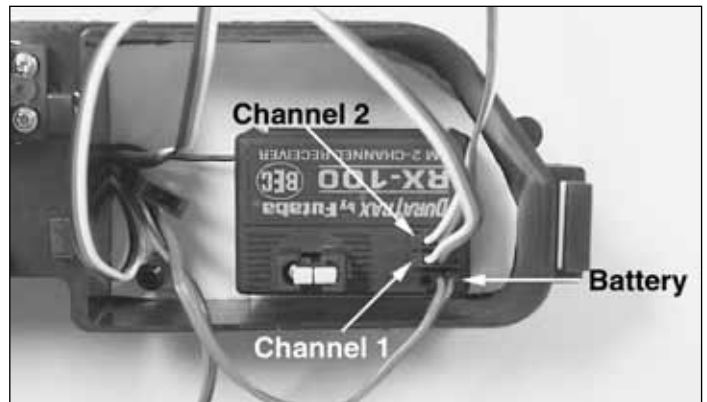

□ 15. Plug the steering servo, throttle servo and switch into the receiver. See your radio instructions to determine which channel is steering and which is throttle. Plug the switch into the battery socket.

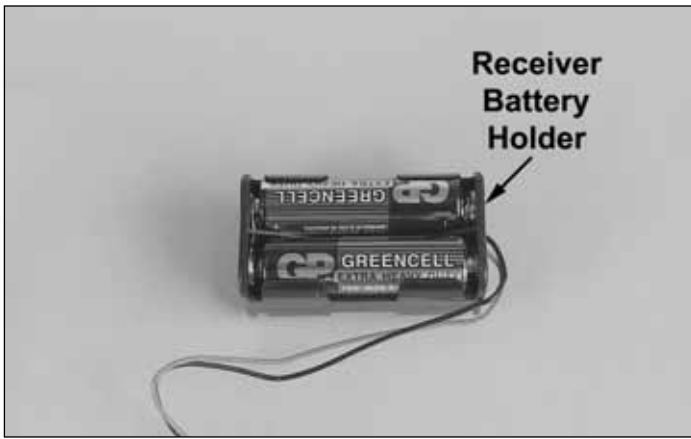

❑ 16. Install 4 “AA” batteries (not included) into the receiver battery holder in the configuration molded into the battery holder included with the radio system.



❑ 17. Install the receiver battery into the radio box. Note the placement of the receiver battery in the box. Connect the receiver battery to the remaining end of the on/off switch.

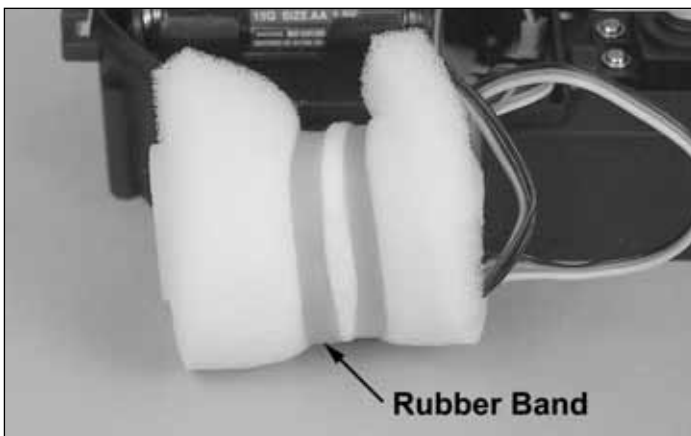

❑ 18. Cut a 2" x 7" (50 x 175mm) piece of the included foam and wrap it around the receiver. If desired, you can wrap a small rubber band (not included) around the outside of the foam to secure it in place for added security.



❑ 19. Install the receiver into the receiver box as shown. Make sure all of the wires are out from under the receiver so that it will properly fit into the radio box.



❑ 20. Cut the left over foam into small pieces and place them around the receiver and battery to help secure them into place. Then slide the radio box cover back onto the radio box.



❑ 21. Run the length of the antenna wire through your fingers to help straighten the wire out, this will make it easier to get the wire through the tube. Slide the antenna wire through the antenna tube. Frequently, there will be leftover wire through the antenna tube (**Do not cut or coil the antenna!**) Cut two pieces of fuel tubing 1/8" wide and slide them over the outside of the antenna tube and wire. This is to help hold the antenna tube on and avoid getting the antenna wire cut in a roll over. Note the placement of the tubing on the antenna tube.

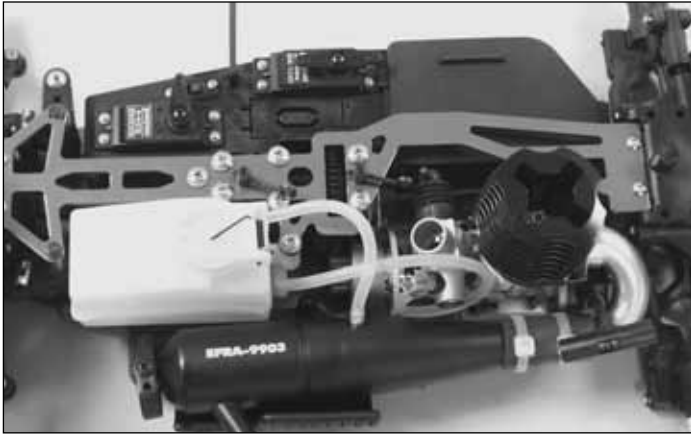

❑ 22. Re-install the radio box back onto the chassis. Use the (8) 3x15mm flathead self tapping screws that you removed earlier to secure the radio box back onto the chassis. Refer to the picture in step 2 on page 6.

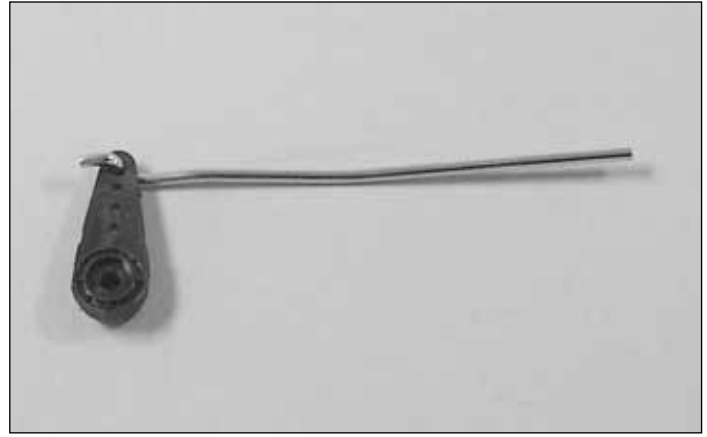

❑ 25. Install the z-bend end of the linkage rod into the servo horn from the bottom as shown.

STEERING LINKAGE

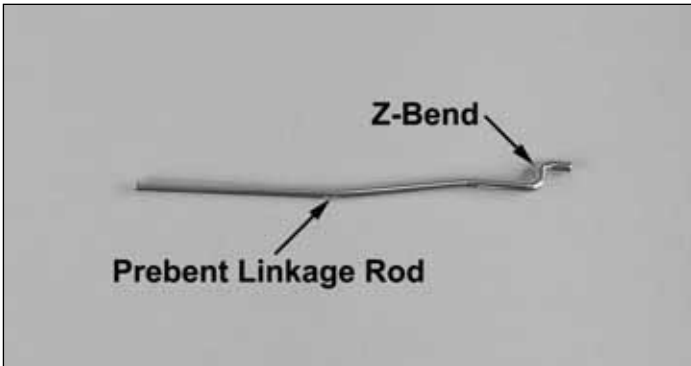

❑ 23. Remove one of the three pre-bent linkage rods with a z-bend at the end of it from the linkage bag. **Note all of the pre-bent rods are the same.**

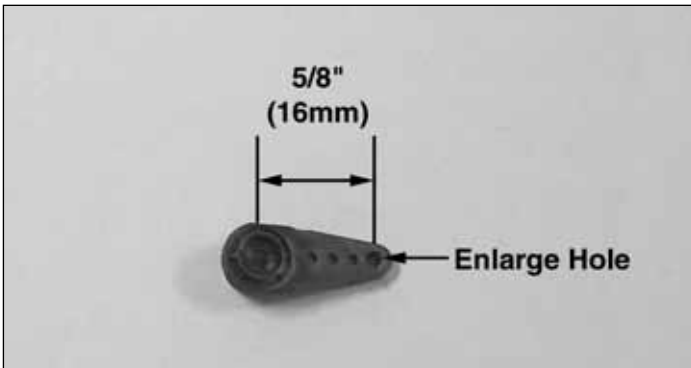

❑ 24. Remove the servo horn from steering servo. Using a 5/64" (2mm) drill bit or hobby knife, enlarge the hole 5/8" (16mm) away from the center of the horn.

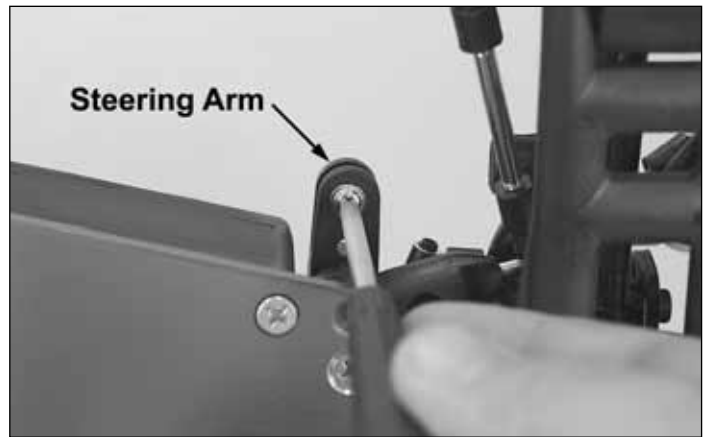

❑ 26. Loosen the screw in the bottom of the steering arm on the servo saver enough for the linkage rod to slide through the metal rod connector.

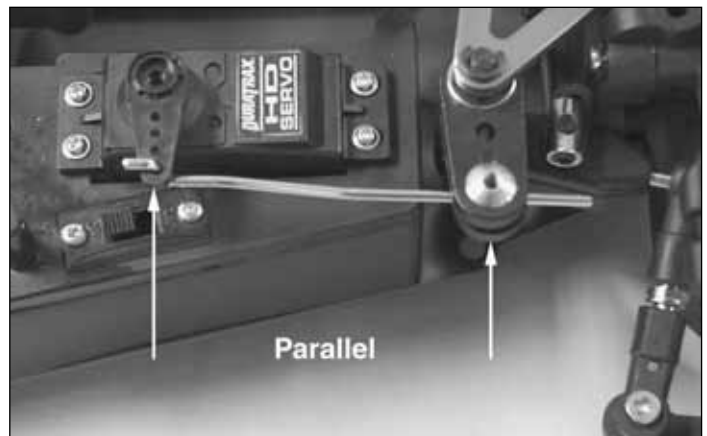

❑ 27. Remove the screw from the steering servo horn. Slide the steering linkage rod through the hole in the linkage rod connector in the steering arm. Place the servo horn back onto the servo. When placing the horn onto the servo, the horn and the steering arm should be parallel as shown in the photo. **Note: Do not screw the servo horn down yet, the servos will need to be centered after assembly is completed.**

BRAKE AND THROTTLE LINKAGE

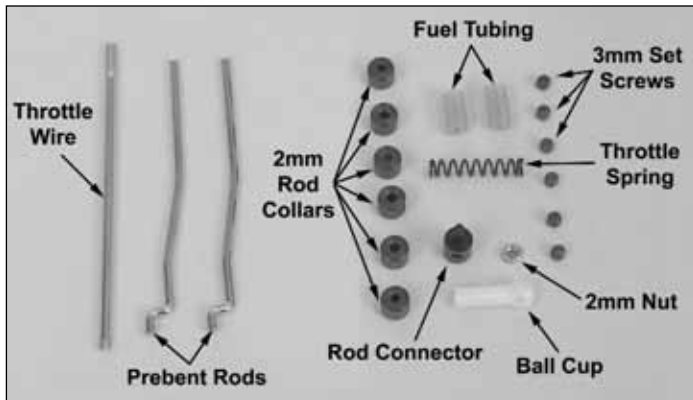

❑ 28. From the linkage bag remove the two remaining pre-bent linkage rods with z-bends at one end, the straight throttle wire, (6) 2mm rod collars, (6) 3mm set screws, (1) throttle linkage spring, (1) rod connector, (1) 2mm nut and (1) plastic ball cup. Also cut (2) 1/4" pieces of fuel tubing from the fuel tubing included with the kit.

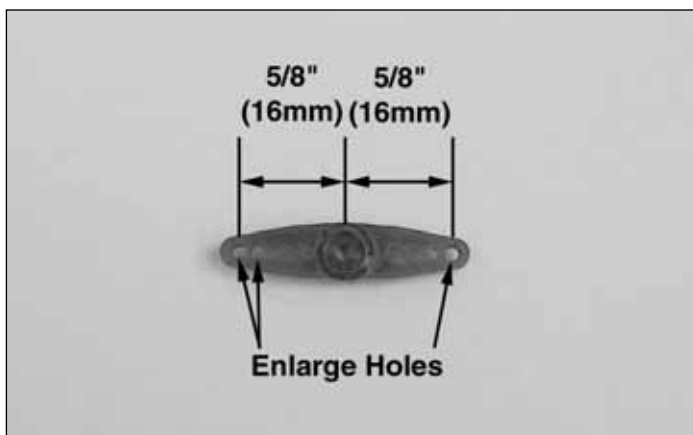

❑ 29. Remove the servo horn from the throttle servo. Using a 5/64" (2mm) drill bit or hobby knife, enlarge the two farthest holes at one end of the servo horn and the farthest hole on the other end.

Rod Connector

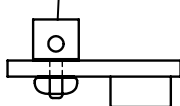

❑ 30. Install the rod connector into the top of the horn at the end with the single enlarged hole. Apply a small amount of thread locking compound onto the threads of the rod connector, then thread on the 2mm nut. Do not overtighten the nut, the rod connector must be able to swivel freely.

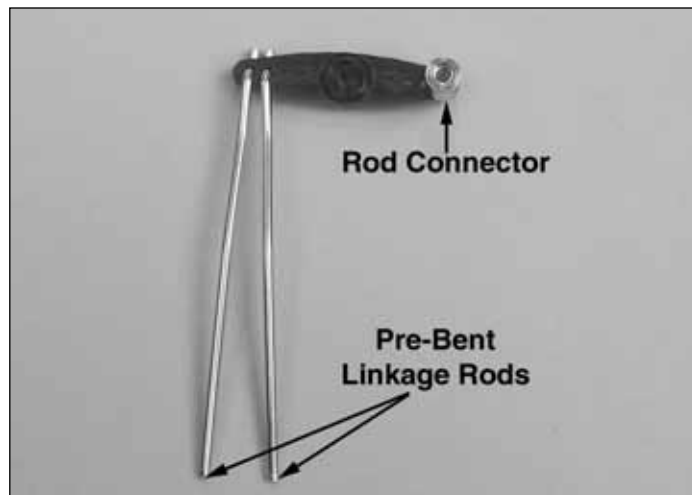

❑ 31. Install the two linkage rods with the z-bends at one end of them into the two enlarged holes at the opposite end from the rod connector.

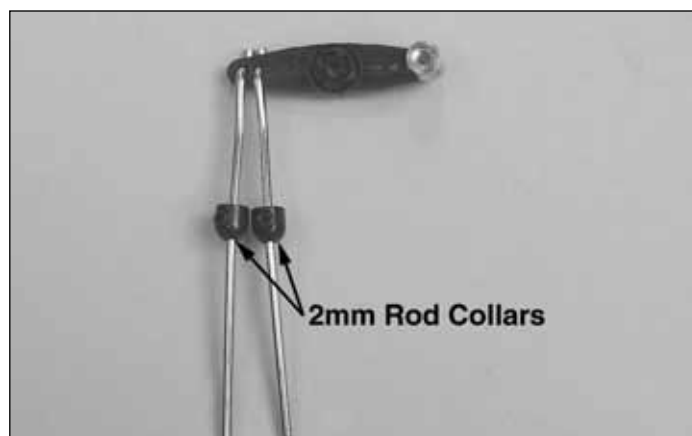

❑ 32. Install the set screw into two of the rod collars. Place one rod collar onto both of the pre-bent linkage rods. **Note: Do not tighten the set screws all the way down yet, the linkage will be adjusted later.**

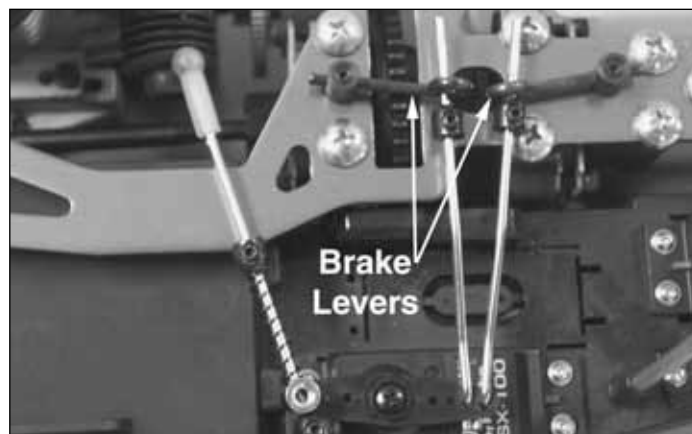

❑ 33. Re-install the servo horn onto the servo. Slide the brake linkage rods through the brake levers as shown.

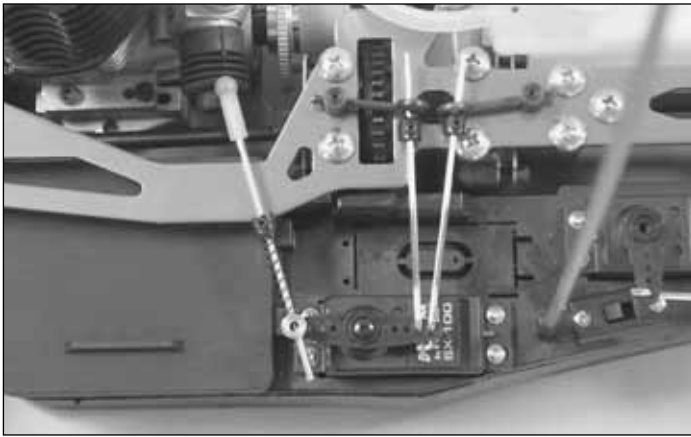

❑ 34. Screw the plastic ball cup onto the throttle linkage wire. Install one rod collar onto the linkage rod, then slide on the throttle linkage spring. Insert the throttle linkage through the rod connector as shown. **Note: Do not tighten the set screw in the rod collar down, adjustments will be made later.**

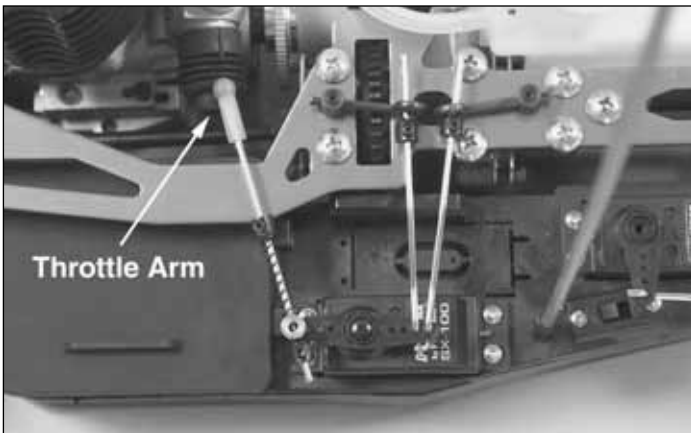

❑ 35. Snap the ball cup onto the throttle arm on the carburetor. Install a second rod collar onto the throttle linkage so that it fits against the rod connector. **Note: Do not tighten the set screw in the rod collar, the linkage will be adjusted later.**

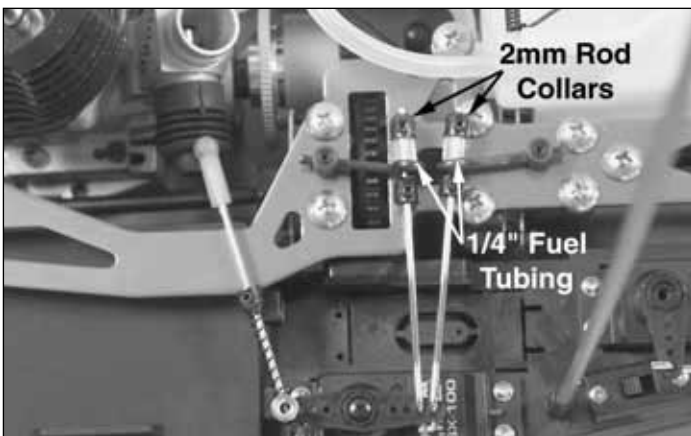

❑ 36. Slide a 1/4" piece of fuel tubing over each of the brake linkage rods. Then install a rod collar onto each of the two rods. **Note: Do not tighten the set screw in the rod collars, the linkage will be adjusted later.**

AIR FILTER AND FUEL TUBING INSTALLATION

❑ 37. Locate the fuel tubing included with the kit. Cut a 6" (150mm) piece to go from the fuel tank to the carburetor and a 4" (100mm) piece to go from the fuel tank to the pressure nipple on the tuned pipe.

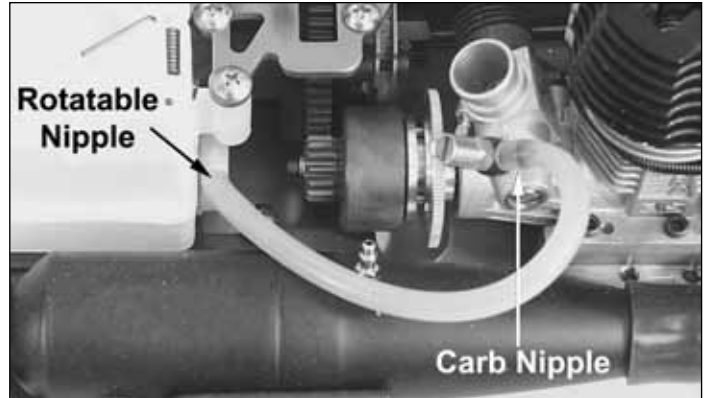

❑ 38. Install one end of the 6" (150mm) piece of fuel tubing onto the rotatable nipple on the rear of the fuel tank and the other end onto the nipple on the carburetor.

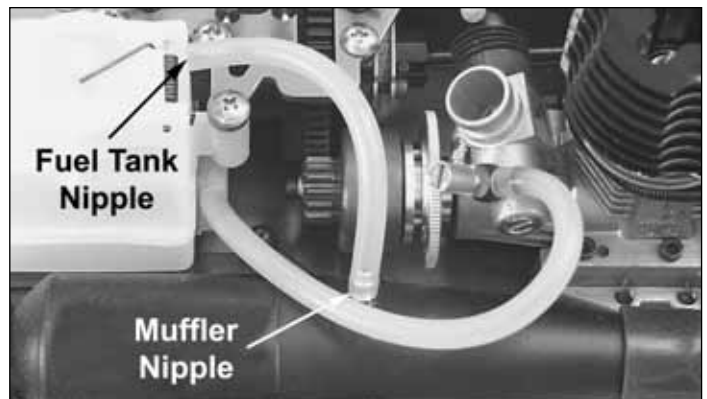

❑ 39. Install one end of the 4" (100mm) piece of fuel tubing onto the nipple next to the fuel tank lid and the other end on the nipple on the muffer.

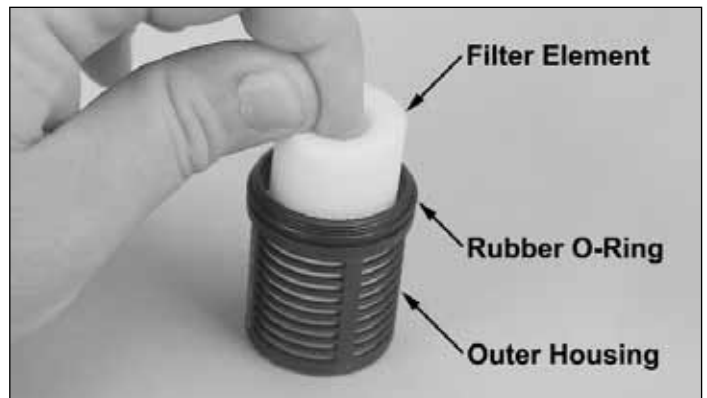

❑ 40. Assemble the air filter. Slide the large rubber O-ring around the threads of the outer housing. The O-ring will help seal the air filter housing together.

❑ 41. Soak the air cleaner element with an air filter oil, light machine oil, or in a pinch, shock oil (not included). Thoroughly soak the foam element and squeeze out the excess. Then install the filter element into the plastic outer housing. Install the filter element into the plastic outer housing.

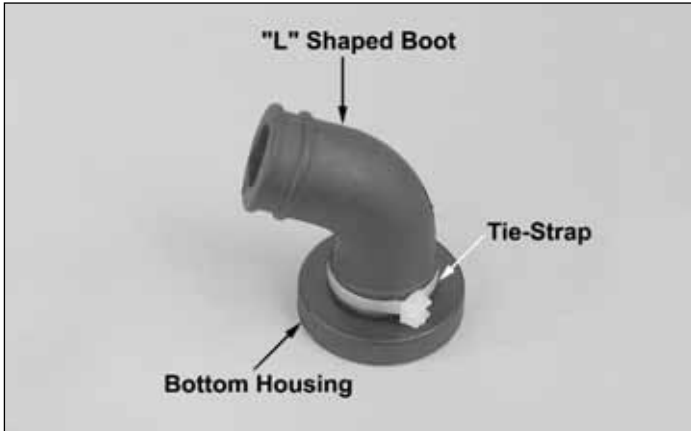

❑ 42. Press the "L" shaped boot onto the bottom housing of the air filter. Using one of the included tie-straps, secure the boot tightly onto the bottom housing. Cut the excess portion of the tie-strap to avoid interference.

❑ 43. Screw the bottom and main filter housing together. **Note: Overtightening will strip the threads.**

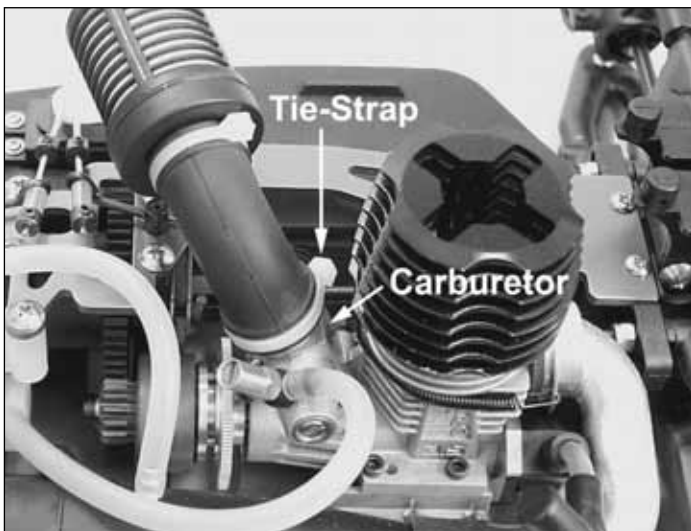

❑ 44. Place the air filter onto the carburetor. Using the remaining included tie-strap, tightly secure the air filter to the carburetor. Cut the excess portion of the tie-strap off to avoid interference.

RADIO ADJUSTMENTS

❑ 45. Turn on the transmitter and receiver and center the steering and throttle trims on the transmitter.

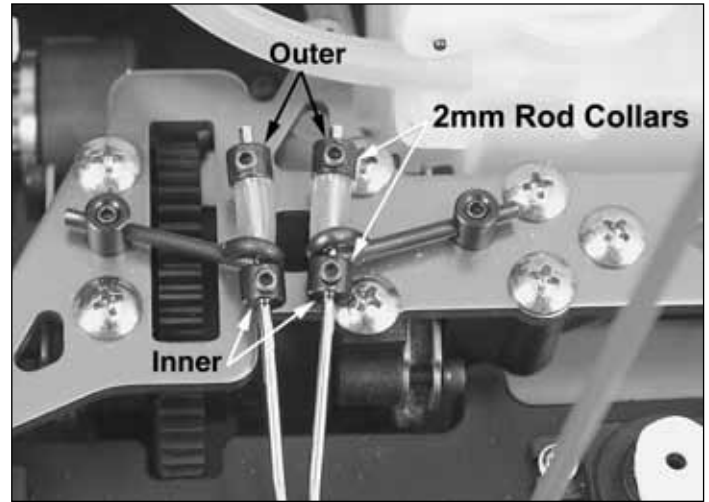

❑ 46. While the transmitter and receiver are still on, make sure that the servo horn is in the position shown in the picture below, aligned with the center line of the chassis. If necessary, remove the servo horn screw, reposition the servo horn and re-install the horn screw. When the servo horn is in the neutral position, slide the outer rod collars and fuel tubing so that the brakes slightly engaged when the car is at an idle. Tighten the set screws on the outer rod collars, then test the brakes by rolling the truck on a flat table or the floor and applying the brakes using the transmitter (by pushing the throttle trigger *forward*.) Return the throttle trigger to neutral and tighten the set screws on the inner rod collars so that the inner collars are 1mm (1/16") from the brake levers. The inner collars will push the brake levers back when the truck is accelerating.

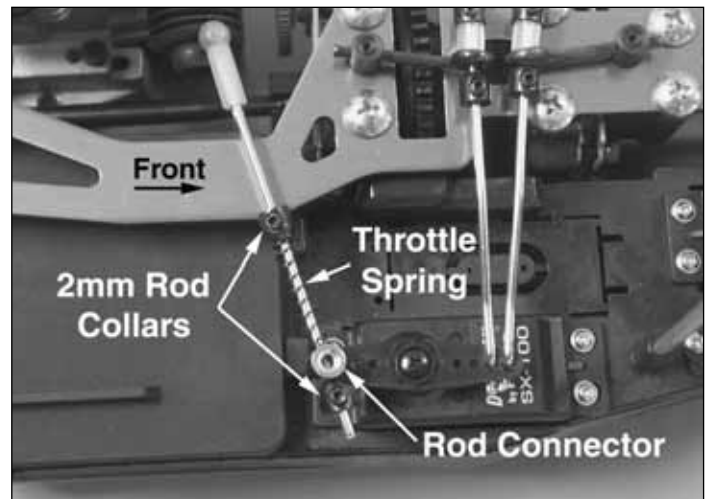

❑ 47. With the throttle servo still in neutral, push the throttle rod so that the carb closes. Move the rod collar against the rod connector and tighten the set screw. Move the other rod collar so that the throttle spring is *slightly* compressed and tighten the set screw.

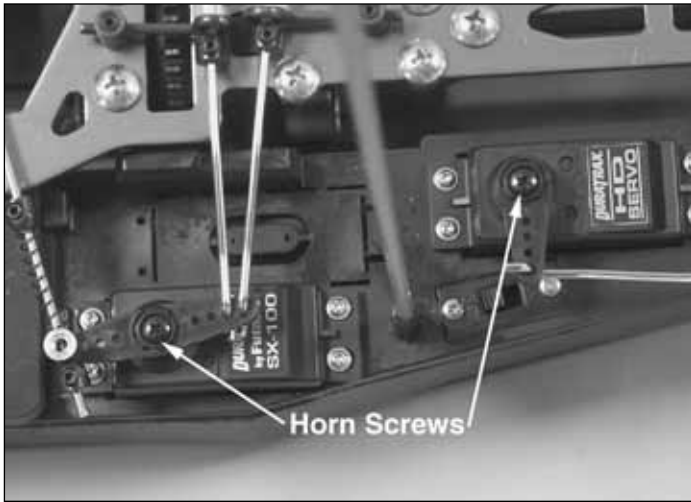

❑ 48. With the transmitter and receiver still on, remove the steering servo horn. While the front wheels are positioned straight, re-install the steering servo horn, so that the wheels remain as straight as possible. The fronts of the wheels may be slightly inward (that's O.K., this is called "toe-in", see page 17.)

❑ 49. Turn off transmitter and receiver.

BODY

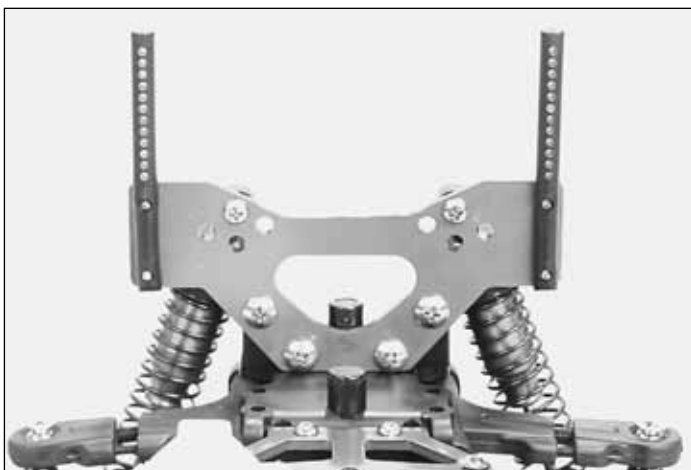

❑ 49. Remove the lower screw from each of the body posts so that the posts can be placed upright. Re-install the screw through the shock tower into the body post as shown. The height of the body can be adjusted by raising or lowering the posts on the shock tower.



❑ 50. Remove the plastic from the outside of the body. Apply the decals to the body if desired.

❑ 51. Remove the body clips from the parts bag. Insert a body clip through bottom hole on each body mount post. Place the body onto the body mounts and secure with body clips. You may choose to trim the body mounts shorter.

CARBURETOR SETTINGS

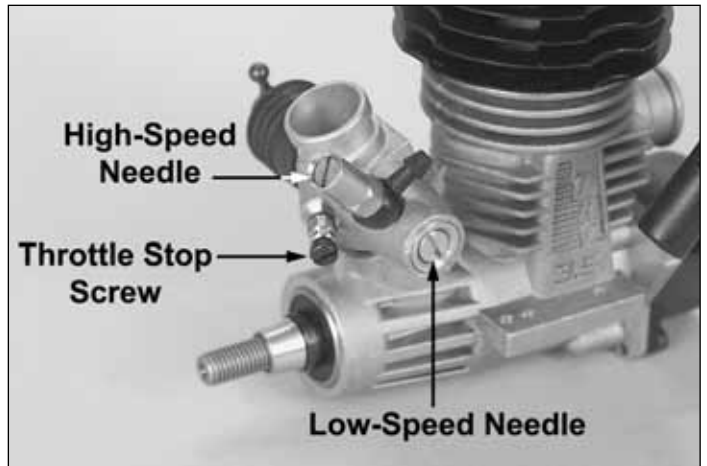

The High-Speed Needle

The "high-speed" needle is sticking up from the side of the carb. It is located in the brass housing, just above the fuel inlet. It controls the fuel to air mixture of the carb. The needle is pre-set for break-in from the factory at 3 turns out from the fully closed position of the carb. Once the engine is broken-in, the high-speed needle would typically run from 2-1/2 to 3 turns out from closed, depending on the weather, humidity and altitude above sea level. To richen turn the needle counterclockwise, to lean turn the needle clockwise.

The Low-Speed Needle

The "low-speed" needle is the screw in the carb body, opposite the throttle arm. It controls the fuel to air mixture at low throttle settings. There is a simple way of adjusting the low-speed needle correctly called the "pinch test." With the engine at idle, pinch the fuel line

and listen to how the engine speeds up or slows down. If the engine increases its speed for about 2 or 3 seconds and then loses speed, the needle is set correctly. If the engine loses RPM quickly, it is set too lean and the low-speed needle needs to be opened (**counterclockwise**) to richen the mixture. Pinch again to check the mixture. If the engine takes longer than 4 seconds to slow down, lean (**clockwise**) the low-speed needle and then pinch again to check the mixture.

The Throttle Stop Screw

On the front of the carburetor, there is a black screw. This is called the idle stop screw. This increases or decreases the idle RPM without changing the fuel to air mixture. The barrel should be approximately 1.5mm (between 1/32" and 1/16") from fully closed.

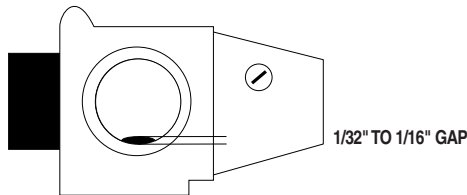

BREAKING IN THE ENGINE

To insure long life and good performance from your Torq .21 engine, you **MUST** break-in the engine. The break-in period is critical for long life of the internal parts of the engine. This should be done over the first 5 or 6 tanks of fuel. Be sure to watch the engine tuning video that came with this kit.

Some Things To Remember During Break-In:

1. Run with the body off. This will keep the engine cooler.
2. Keep the air cleaner on at ALL times
3. Run on a smooth, hard surface. An empty parking lot is perfect.
4. Use the same fuel that you will use for normal running.
5. Resist the urge to accelerate and decelerate the truck quickly.
6. Break-in puts stress on the glow plug and you can burn it out during break-in. Make sure you have an extra plug or two on hand.
7. Do NOT overheat the engine. You can check the head temperature by using one of the temperature gauges that are available or by putting a drop of water on the top of the cylinder head. If the water boils away immediately, shut off the engine and allow it to cool. If it takes more than 10 seconds to boil away, the engine is at proper running temperature for break-in.

RUNNING THE ENGINE

Before running the engine, read the manual and watch the engine video that came with this kit.

There are several simple steps to starting the engine:

1. Install a glow plug if one is not in your engine. This threads into the top of the cylinder head.
2. Fill the tank almost to the top. Leave a little air at the top of the tank.
3. Prime the engine by turning the flywheel on the engine. Watch the fuel go through the line and when it gets to the carburetor, turn the flywheel one more full revolution.
4. Open the high speed needle valve exactly 3 turns out (**counterclockwise**) from fully closed. **The high-speed needle is sticking up from the carburetor inside the brass housing.** All of the carburetor settings are adjusted with a flat bladed screwdriver. If you have previously run the truck, keep the same needle valve setting that you used on your last run.
5. Start the engine by pulling the recoil - Use short, quick pulls. **DO NOT** pull the recoil starter's string to the end. You only need 10 to 12 inches of pull to start the engine.

If the engine does not start after several pulls, sometimes it is helpful to start the engine at around half throttle. Have a friend pull back on the throttle some while you start the engine. This *may* be an indicator that the low speed needle setting needs to be adjusted. When the engine starts, immediately return the throttle to idle. If this is not done the engine can over-rev and cause engine damage. **If the engine is difficult to turn over with the recoil starter, especially if it is brand new, loosen the glow plug a half turn before starting the engine. This allows some compression to escape, but the engine will still start. Make sure you tighten the glow plug after the engine starts.** If the recoil starter is still difficult to pull, the engine is flooded – there is too much fuel inside the engine. Remove the glow plug and air cleaner, then turn the engine upside down and pull the recoil 5 or 6 times. This will clear the engine of fuel, and you will notice the recoil pulls easier. Replace the glow plug and repeat the starting procedure.

Fuels

Use fuels that are specially formulated for car and stadium truck engines. DuraTrax Red Alert fuel is specially formulated for buggy engines like the Torq .21.

How To Stop Your Engine

You may have been wondering how to stop the engine. All you have to do is pinch the fuel line that runs to the carburetor and from the bottom of the fuel tank. Pinching this will restrict the fuel flow and the engine will quit within a few seconds. You can also touch the flywheel with the tip of your shoe through the hole in the bottom of the chassis.

The First Tank

Your first tank of fuel should be running the truck at a very rich high-speed needle valve setting. This allows the fuel to carry as much oil as possible into the engine to lubricate the internal parts during the break-in.

1. Open the needle valve 3 turns from fully closed (counterclockwise). This is factory set already, but check it to make sure. When closing the high-speed needle, close the needle until you feel some resistance. **DO NOT** overtighten or you will damage the engine.
2. Start the engine.
3. Once the engine is started, open the high-speed needle valve around 1/8 turn at a time, finding the setting where the engine just barely runs. This may take a few times adjusting the needle, running the truck away from you and back, then adjusting the needle. The truck will perform sluggishly and stall from time to time - that is normal.
4. Run the truck back and forth at medium speeds, slowly accelerating and decelerating the truck.
5. After a minute or two of running, make sure the engine is not overheating by putting a drop of water on the cylinder head and watching it boil away. If it boils away within 10 seconds, stop the engine and allow it to cool. Open the high-speed needle around a 1/4 turn before starting again. This is a good habit to get into every time you run to ensure that the engine does not overheat during any run. Looking at the smoke that comes out the exhaust is also an indicator of how rich or lean the engine is running. If there is a good amount of smoke coming out of the exhaust, then chances are good that you are running rich.
6. Run the truck back and forth at a medium speed until the tank is almost out of fuel. Do not allow the tank to run out of fuel. This leans out the engine and can cause overheating (See **How To Stop Your Engine**).
7. Stop the engine and allow the engine to cool before the second tank. This normally takes around 10 minutes.

Tanks 2-6

Turn in the needle valve (clockwise) around 1/12 turn from the previous setting. Run the truck back and forth. You should notice that the truck will perform better during each run. Stop the truck periodically to check for overheating. If it is too hot, stop the engine. Wait for it to cool, then open up the needle valve and restart. After the 6th tank, you should be near to the peak performance of the engine.

ENGINE MAINTENANCE

Ten Ways To Ensure A Long Life From Your Engine:

1. Keep your engine clean. Dirt will act as insulation on an engine. It will not be able to shed heat as easily. Use a good air filter to keep dirt out of your engine and clean it often.
2. Do not over-lean your engine.
3. Do not run your engine with little or no load. Don't throttle up the engine to full throttle when the wheels are not in contact with the ground.
4. Do not overheat the engine. This goes along with keeping it clean and not over-leaning the engine.
5. Do not use a fuel with a low oil content. Make sure you use a fuel from a reputable manufacturer, such as DuraTrax Red Alert.
6. Avoid using old fuels in the engine. Always run all of the fuel out of the engine. After running for the day, use an after-run oil and work it into the engine by turning the flywheel or pulling the engine recoil slowly.
7. Do not use a fuel with a nitromethane (often called nitro) content over 20%.
8. Do not scratch the piston or cylinder sleeve. Avoid jamming something into the exhaust port when removing or re-installing the clutch or flywheel. Use a special tool called a crankshaft locking tool, which is installed in the glow plug hole.
9. Do not use silicone sealer on the engine joints. Silicone sealer contains acetic acid, which is corrosive if it gets inside your engine.
10. Do not allow any water inside the engine. This sounds easy, but temperature changes can cause condensation inside the engine. This is a good reason to use an after-run oil. Store your engine inside the house, not in a garage or shed where there will be temperature extremes.

If you are having problems with your engine consult the engine troubleshooting flow chart on the back cover. The following are some potential problems.

Glow Plug

The glow plug is an item that will wear out and need replacement from time to time. It is a good idea to remove the glow plug before your first run, heat it and see how well it glows. You should see a bright orange glow from the filament. If a coil or two will not glow or the plug will not glow at all, replace the plug. If the engine quits when you remove the glow starter, the plug might need to be changed, although this may be because you are running too rich and need to screw in your high-speed needle some. Look at the glow plug when you are running the engine. If you see some bubbles coming from around the plug, replace the glow plug (copper) gasket, or both the plug and gasket. The only real way to test a glow plug is to replace it. Make sure you have a spare plug or two on hand every time that you run the Nitro Demon.

Fuel

Fuel can go bad. The main ingredient in model fuel is methanol, which is basically an alcohol. Alcohols can absorb water out of the air, so keep your fuel jug capped at all times. Store your fuel out of the sunlight and in a cool place. Bad fuel is one of the most difficult problems to diagnose in engines. If you have tried everything you can think of to remedy an engine that is not running correctly, try using some fresh fuel.

Fuel line is susceptible to pinhole leaks. You cannot see the hole in the fuel line, but if you see air bubbles in the line going to the carburetor, replace the fuel line. Another symptom of a leak in the fuel line is a surging engine. The properly tuned engine will surge when the air bubbles hit the carb. It is basically leaning out the mixture.

To keep dirt out of the engine, we recommend that you use an inline fuel filter on the fuel line running from the fuel tank to the carburetor. Dirt can get caught in the needle seat and cause an inconsistent running engine. If you suspect that some dirt has lodged itself in the carb, remove the needles and clean the carb with denatured alcohol or fuel. It can help to use compressed air to blow out the fuel passages as well. Dirt can get into your carburetor and engine through the air filter. Ensure that your air cleaner has a good seal to the top of the carb. Periodically wash the air cleaner foam element and re-oil the filter. Any air cleaner that has a torn element or a bad seal should be replaced immediately.

Overheating

One of the worst things you can do to your engine is overheat it. The oils that lubricate the engine are carried in the fuel. If your engine is set too lean, there will not be enough oil in the engine to lubricate the internal parts. This will cause premature wear in the engine and cause damage. We have talked about overheating in other parts of this manual, but we want to stress the proper techniques to check for overheating. The easiest way of checking the temperature of the cylinder head is using one of the available temperature gauges. This will give you a direct reading of the cylinder head temperature. Do not let the head temperature exceed 220° Fahrenheit (104° Celsius). Another way of checking the head temperature is to put a drop of water on the cylinder head. If it boils away within 10 seconds, the high-speed needle is set too lean. If the water boils away in around 15 seconds, the engine is within proper operating temperatures. If the water boils away longer than 15 seconds, the mixture is set rich which is preferable when breaking in the engine. Otherwise lean the mixture some and retest after a minute of running.

PERFORMANCE TUNING

Ride Height: This refers to the clearance between the ground and the chassis, both at the front and the back of the truck. The general rule is to have the suspension arms perfectly level when the car is at rest. To determine the ride height, drop the truck from around 6"-12" above flat ground. Drop the truck, making sure it drops flat. Check where the suspension arms come to rest. You can adjust ride by moving the spring adjusters on the shock, which are at the top of each shock spring, until the arms are level after the drop test.

Toe-In/Toe-Out: This refers to the angle of the front tires when viewed from above when the suspension arms are level. If the fronts of the tires angle in, it is called "toe-in" and if the fronts of the tires angle out, it is called "toe-out." In front, this is adjusted by lengthening or shortening the steering rods - the rods that run between the front hub and the servo saver. The rear toe-in is adjusted by the large turnbuckles behind the rear suspension. Normally a small amount of toe-in is used to make the truck track straight at high speed. Too much toe-in will make the truck difficult to turn as well as reduce the overall top speed because of tire scrub. Sometimes a small amount of toe-out will be used to help the steering. As a general rule use a small amount of toe-in.

MAINTENANCE TIPS

Camber: Camber is the angle of the tops of the tires when viewed from the front. Negative camber is when the tops of the tires are angled towards the center of the truck. Positive camber is where the tops of the tires are angled away from the center of the truck. Positive camber is very rarely used, if ever. A small amount of rear negative camber is helpful to increase traction in the rear. Negative camber at the front will increase stability. Camber adjustments can be made on the Nitro Demon by turning the “camber rods,” which are the upper links on the suspension. Lengthening the camber rod will add positive camber and shortening the camber rod will add negative camber.

Shocks: Changes in shock oils, springs, and pre-load on the springs can dramatically change the way the car handles. A thicker shock oil will make the truck turn faster but reduces overall traction and handling over bumpy surfaces. Thinner oil will increase traction at the expense of steering response and the car will tend to roll more. In general, shock oils between 20 and 40 weight will be best for your stadium truck. You should experiment some to see what oils work best for your track and driving style. Shock springs affect the rate that the suspension rebounds from a bump. We have supplied soft springs that work under most conditions. Pre-load on the springs means that the springs are already compressed some so that the suspension will rebound faster. Sometimes you will want to pre-load one side when the track has turns all or mostly in one direction, for instance an oval track. It will also increase the ride height.

Before Each Run

- Check for loosened screws on the truck. Engine vibration will loosen some of the screws, particularly in the engine mount area. Use thread lock on screws that thread into metal parts or use a metal nut.
- Inspect the air cleaner for a torn or damaged element. Also look for dirt in the air cleaner element and wash it if necessary.
- Check the suspension and drive train for binding.
- Inspect all of the wires for damage. Also check the connectors to make sure all of them are tight and in the proper place.
- Check the fuel tank and fuel lines for leaks.
- Before starting the engine, turn on the radio and make sure the servos move easily and in the right direction.
- Before running always check the condition of your radio system batteries and replace/recharge if necessary.

After Each Run

- Drain the fuel tank of any leftover fuel. **DO NOT** return it to your fuel jug.
- Put some after-run oil in the carb and turn the flywheel several times to work the oil into the engine. This will protect the engine from rusting, especially when stored for a long period of time.
- Check again for loosened screws.
- **CLEAN** the truck. Wipe off any oils that have collected on the chassis, engine end exhaust. Oils will attract dirt on the next run.



Metric Conversions		1/4" =	6.4 mm	6" =	152.4 mm
1/64" =	.4 mm	3/8" =	9.5 mm	12" =	304.8 mm
1/32" =	.8 mm	1/2" =	12.7 mm	18" =	457.2 mm
1/16" =	1.6 mm	5/8" =	15.9 mm	21" =	533.4 mm
3/32" =	2.4 mm	3/4" =	19.0 mm	24" =	609.6 mm
1/8" =	3.2 mm	1" =	25.4 mm	30" =	762.0 mm
5/32" =	4.0 mm	2" =	50.8 mm	36" =	914.4 mm
3/16" =	4.8 mm	3" =	76.2 mm		

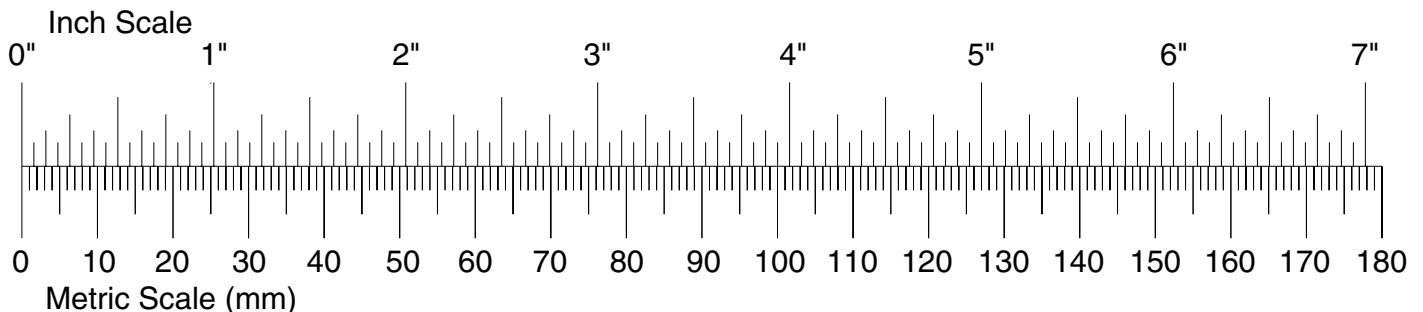

ENGINE TROUBLESHOOTING

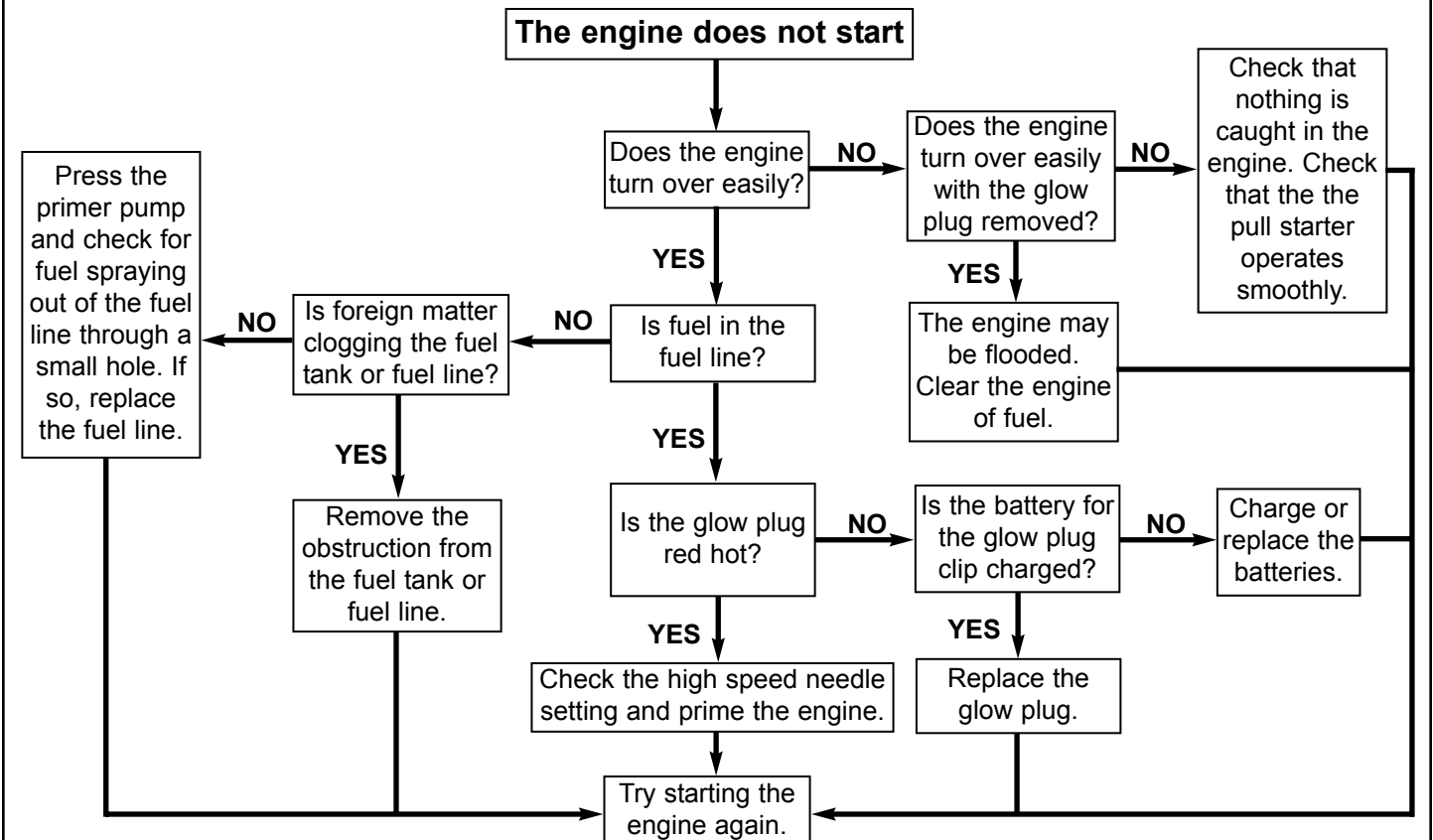
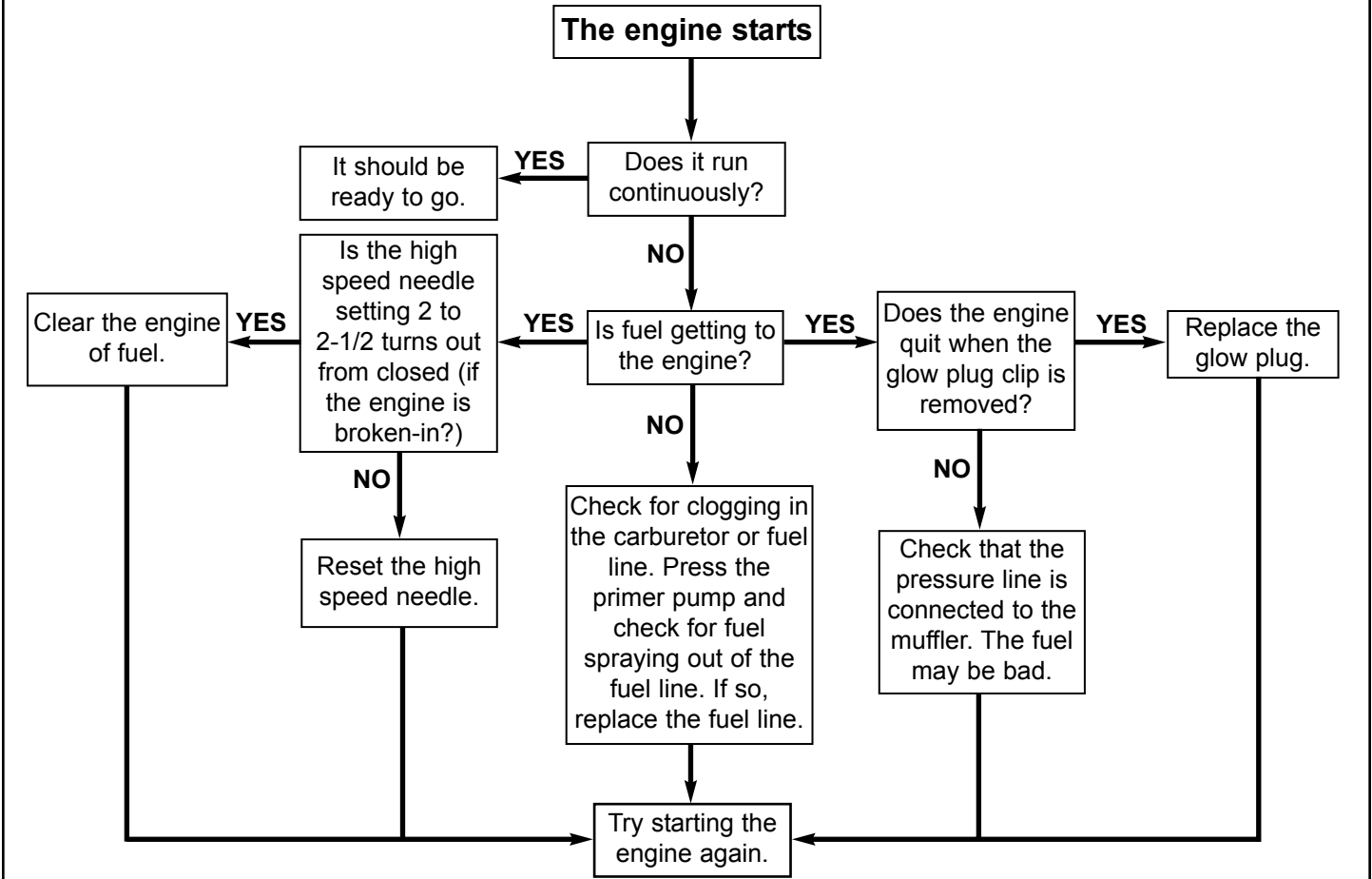

ACCESSORIES AND OPTIONAL PARTS



DuraTrax Nitro Starter Set

This set includes everything you need to start racing. 5-way glow plug wrench, 1 qt. of Red Alert fuel, Rapid Heat® glow starter w/charger, fuel bottle and glow plug. **DTXP0200**



DuraTrax Crankshaft Locking Tool

Remove your engine's clutch safely with this easy to use, anodized metal tool. Works with all .10 to .21 car and truck engines. **DTXR1100**



Rapid Heat Glow Starter w/ Charger

Rapid Heat's 1500mAh Sanyo® NiCd sends power to a 1-3/4" socket with the distinctive Twist-and-Lock tip. Made of durable metal, with a vinyl cap to protect the tip from fouling. A 110V AC charger is included for overnight recharging. **DTXP0150**



DuraTrax Ultimate Car Wrench

This chromed, cast metal wrench has threaded holes for storing up to 4 glow plugs; a combination slotted/phillips screwdriver bit; and seven socket head sizes. Bits fit into a 6mm hex shank inside both the long 8mm socket (for easy access) and the 12mm socket (for more torque). **DTXR1175**



DuraTrax Red Alert™ 20% Racing Fuel

To make your TORQ™ 21 engine run faster, better and longer, you need the unique formula of DuraTrax Red Alert. Red Alert contains 20% nitro plus a carefully race-tested blend of castor and synthetic oils. **DTXP0600**



DuraTrax XL Deluxe Field Bag

Keep your gear loaded and race ready with the XL Deluxe Field Bag. Heavy duty black nylon bag with red trim and white logo. **DTXP2010**



Engine Tuning Screwdriver

Now you don't need separate drivers for adjusting high- and low-speed needles and throttle stop screws — just this one! The hardened chrome vanadium steel shaft is 120mm long and plenty tough, and the 3.2mm wide tip is magnetized for added convenience. **DTXR0185**



Pit Tech Deluxe Car Stand

The sturdy stand disassembles easily and stores flat. The plate rotates for all-sides access, and built-in holes keep shocks handy when rebuilding. Molded rubber inserts grip chassis securely, and the dropped center accommodates models with uneven chassis bottoms. **DTXC2370**



Transmitter Nicd Conversion Kit

Save by powering your transmitter with rechargeable NiCds! This kit includes eight "AA" Sanyo® NiCd cells and a 110V AC wall charger. Connect it to the radio's charge jack, and you can recharge the batteries in just 2-3 hours — without removing them from the transmitter. **DTXP4010**