

**DURATRAX**  
**MAXIMUM**  
**MT**™

**ASSEMBLY AND OPERATION MANUAL**



**Warranty**

- DuraTrax® will warranty this kit for 90 days after the purchase date from defects in materials or workmanship. DuraTrax will either repair or replace, at no charge, the incorrectly made part.
- Make sure you **save the receipt or invoice** you were given when you bought your model! It is your proof of purchase and we must see it before we can honor the warranty.
- To return your Maximum MT for repairs covered under warranty you should send your truck to:

Hobby Services  
1610 Interstate Drive  
Champaign, Illinois 61822  
Attn: Service Department  
Phone: (217) 398-0007 9:00 am - 5:00 pm Central Time M-F  
E-mail: [hobbyservices@hobbico.com](mailto:hobbyservices@hobbico.com)

**Before Building:**

We want the building and operating of this vehicle to be a success, so **BEFORE** removing any parts from the parts bags please read this manual thoroughly and watch the included video to familiarize yourself with the model. If for any reason you think this model is not for you, return it to your dealer immediately. **PLEASE NOTE:** Your hobby dealer cannot accept a return on any model after assembly has begun.

## TABLE OF CONTENTS

Introduction.....	2
Safety Precautions .....	2
Helpful Hints.....	2
Stress-Tech™ Parts Guarantee.....	2
Repair Service.....	2
Specification & Description Changes.....	3
Screw Information .....	3
Required Items for Completion .....	3
Tools You Will Need.....	3
Finishing the RTR Version.....	4
Assembly of the Pre-Built Version.....	7
Preparing the Radio System.....	7
Steering Servo Assembly .....	7
Assembling the Radio Tray .....	8
Installing the Throttle Servo .....	10
Throttle & Brake Linkages.....	10
Radio Adjustments .....	11
Prepare the Engine.....	12
Finishing.....	13
Carburetor Settings.....	14
Breaking-In the Engine .....	15
Running the Engine.....	15
Engine Maintenance .....	16
Performance Tuning .....	17
Maintenance Tips.....	18
Engine Trouble Shooting .....	19

## INTRODUCTION

Thank you for purchasing the DuraTrax Maximum MT. This manual contains the instructions you need to build, operate, and maintain your new nitro R/C truck. Read over this manual thoroughly before building or operating the Maximum MT.

## SAFETY PRECAUTIONS

When the safety precautions are followed, the Maximum MT will provide years of enjoyment. Use care and good sense at all times when operating this radio controlled truck. Failure to use this vehicle in a safe, sensible manner can result in injury or damage to property. You and you alone must insure that the instructions are carefully followed and all safety precautions are obeyed.

- Do not operate the Maximum MT near people. Spectators should be behind the driver or at a safe distance away from the vehicle.
- The engine and exhaust system produces quite a bit of noise. If you are disturbed by the amount of noise this truck produces, wear ear protection such as earplugs. Do not run this vehicle when or where it can disturb others.
- The engine and exhaust system can become very hot. Avoid touching any of these parts during use and until they have cooled down.
- Model engine fuel is poisonous. Make sure you read and follow all of the precautions on the fuel container. Keep fuel out of the reach of children.

- Model engine fuel is flammable and when ignited has a flame that is difficult to see. Avoid sparks, flames, smoking, or any other ignition source when fuel is near.
- The engine emits carbon dioxide just like real cars. Do not operate this model indoors.
- Before turning on the transmitter, make sure that no one else is on your frequency.

## HELPFUL HINTS

- Avoid working over a deep pile carpet. If you drop a small part or screw, it will be difficult to find.
- Place a mat or towel over your work surface. This will prevent parts from rolling off and will protect the work surface.
- Avoid running the truck in cold weather. The plastic and metal parts can become brittle at low temperatures. In addition, grease and oil become thick, causing premature wear and poor performance.
- Test fit all parts before attaching them permanently.

## STRESS-TECH™ PARTS GUARANTEE

We have engineered the Maximum MT to take the rough and tumble abuse that makes R/C fun. We are so confident of the quality and durability of the Stress-Tech™ plastic parts that we will replace any Stress-Tech plastic part you break during the first 6 months you own the truck. Just send in the part to us and we will send you a **Free** replacement. Please see the Maximum MT parts list for the items covered under the Stress-Tech guarantee.

To receive your free replacement part please send the following to the Hobby Services address listed on the cover of this manual:

- The broken part must be included.
- The part number and description of the broken part.
- Dated copy of your invoice or purchase receipt.
- Your name, phone number and shipping address.

## REPAIR SERVICE

Repair service is available anytime.

- After the 90 day warranty, you can still have your Maximum MT repaired for a small charge by the experts at DuraTrax's authorized repair facility, Hobby Services, at the address listed on the cover of this manual.

To speed up the repair process, please follow the instructions listed below.

1. Under most circumstances return the **ENTIRE** system: truck and radio. The exception would be sending in a Stress-Tech part. See the instructions under the Stress-Tech Guarantee.
2. Make sure the transmitter is turned off, all batteries are removed, and fuel is drained from the tank.
3. Send written instructions which include: a list of all items returned, a **THOROUGH** explanation of the problem and the service needed, and your phone number during the day. If you expect the repair to be covered under warranty, be sure to include a proof of date of purchase (your store receipt or purchase invoice).
4. Also be sure to include your full return address.

## SPECIFICATION & DESCRIPTION CHANGES

All pictures, descriptions, and specifications found in this instruction manual are subject to change without notice. DuraTrax maintains no responsibility for inadvertent errors in this manual.

## SCREW INFORMATION

Do not use too much force when tightening self-tapping screws into plastic. Overtightening will cause the threads in the plastic to strip. We recommend that you stop turning a self-tapping screw when you feel some resistance as the head of the screw comes in contact with the plastic. Avoid using powered screwdrivers when assembling this kit. They tend to overtighten the screws. Do not use thread locking compound on any self-tapping screws. The thread locking compound may damage the plastic. **IMPORTANT:** Use thread lock on any fastener that is threaded into metal or fastened with a nut. Vibration from the engine will cause the screws to loosen if thread locking compound is not used.

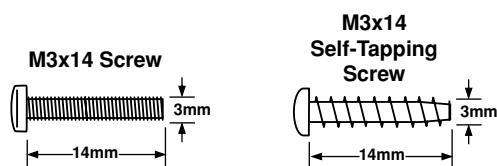

The illustration above shows how to identify the types of screws used throughout this instruction manual.

## REQUIRED ITEMS FOR COMPLETION

To operate the Maximum MT these items are required:

- Glow plug starter (Hobbico® Hot-Shot™ 2 -HCAP2520)
- Fuel bottle (DuraTrax Kwik-Pit™ Bottle - DTXP0125)
- Fuel (DuraTrax Red Alert™ fuel - DTXP0520)
- Air filter oil
- Tie straps
- Hobby knife with #11 blade (HCAR0105)
- Glow plug wrench (DTXR1170)
- It is also helpful to have a couple of extra glow plugs on hand. We recommend the O.S® #A3 plug (OSMG2690)



*(All of these items are available in a Nitro Starter Pack from DuraTrax - DTXP0200).*

For the Pre-Built version of the Maximum MT, you will also need:

- 2-channel radio with (2) standard servos
- (12) "AA" batteries - (4) for the receiver and (8) for the transmitter
- Small bottle of thread locking compound (GPMR6060)

## TOOLS YOU WILL NEED

To assemble the Pre-Built version (DTXC0055), you will need the following tools:

- Phillips head screwdriver
- Flat blade screwdriver
- Needle-nose pliers
- Wire cutters
- Hobby knife (HCAR0105), #11 blades (HCAR0211)
- Drill with 1/4", 1/8", 5/64" (or 6mm, 3mm, 2mm) bits

## FINISHING THE RTR VERSION (DTXD64\*\*)

- ❑ 1. Remove the transmitter and truck from the box.

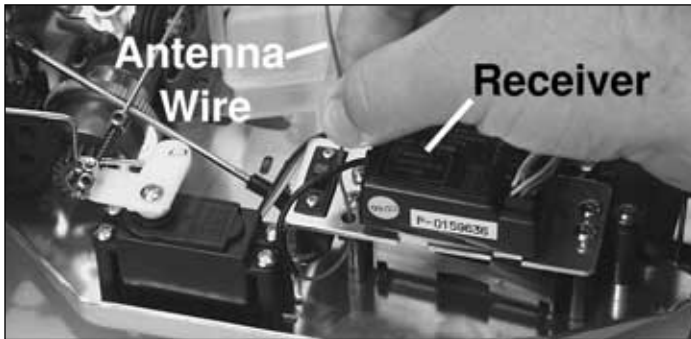

- ❑ 2. Remove the twist-tie from the receiver antenna. (The receiver antenna looks like a bundled thin wire that is attached to the receiver.) Thread the receiver antenna underneath and through the hole in the radio plate next to the receiver switch.

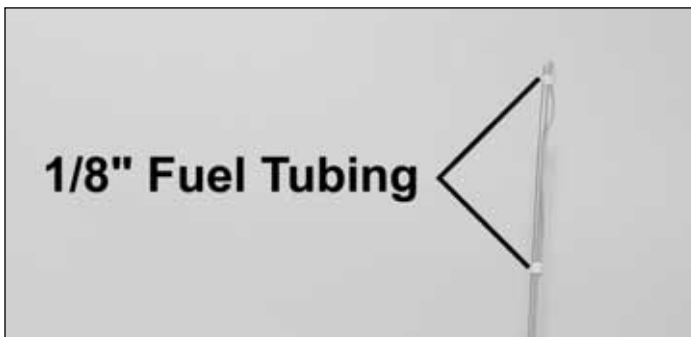
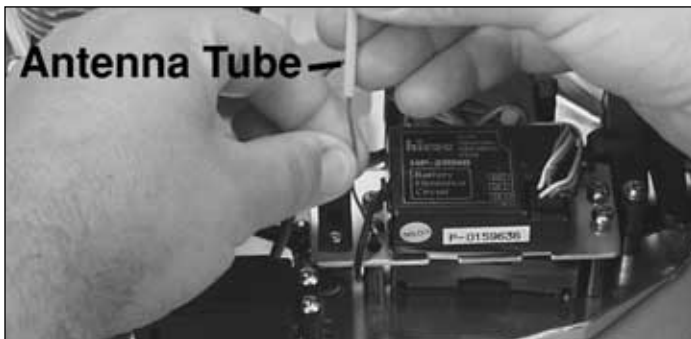

- ❑ 3. Remove the antenna tube from the parts bag. Thread the receiver antenna through the antenna tube. The antenna will be longer than the antenna tube. **DO NOT COIL OR CUT THE ANTENNA.** Press fit the antenna tube through the hole in the radio plate. Place a 1/8" long piece of fuel tubing over the antenna tube and wire to secure in place. **TIP:** Run the antenna through your fingers to straighten out kinks before running through the antenna tube.

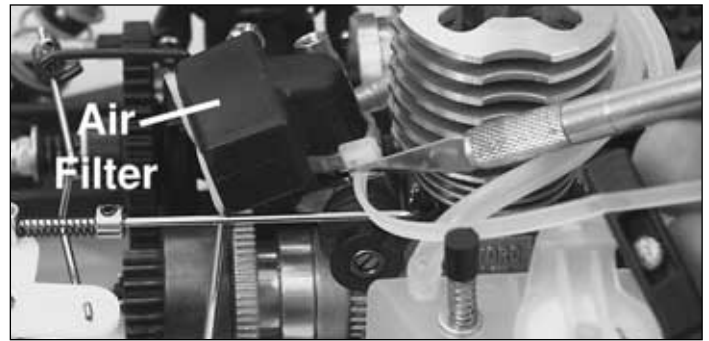

- ❑ 4. Remove the air filter and tie strap from the parts bag. Thoroughly soak the air filter foam with some oil (not included) and then squeeze out the excess oil. A light machine oil (like 3-IN-ONE™) will work well. Special oils made for air filters are also available in most hobby and motorcycle shops. Place the air filter onto the carburetor and secure it in place with the tie strap. Cut off the excess part of the strap.



- ❑ 5. Remove the four screws from the top of the radio plate and remove the receiver battery holder.



❑ 6. Remove the receiver battery holder from the radio box. Install (4) “AA” (included) into the battery holder in the configuration molded into the battery holder.



❑ 7. Re-install the receiver battery holder under the radio plate. Make sure that the receiver switch is in the off position. Plug the connector on the receiver battery into the socket on the receiver switch. Tuck the wires between the servo and receiver battery so they will not get caught on anything.

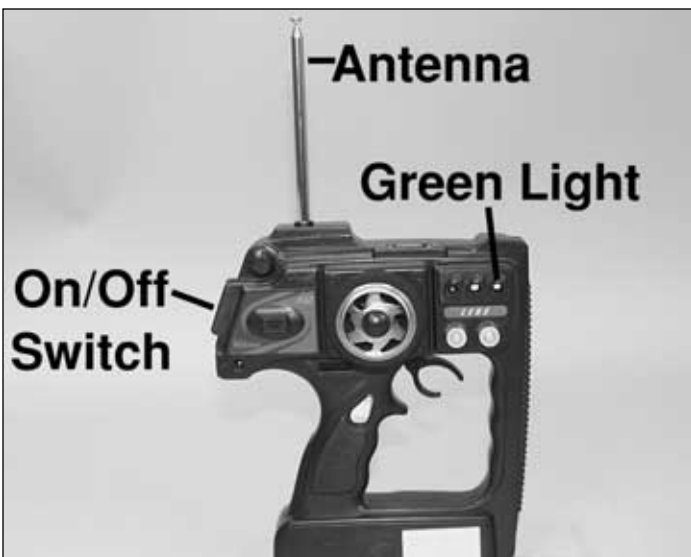

❑ 8. Remove the transmitter antenna from the holder and screw it into the hole on top of the transmitter.



❑ 9. Slide open the battery door on the bottom of the transmitter and remove the transmitter battery holder. Place 8 “AA” batteries into the holder in the configuration molded into the plastic on the battery holder. Re-install the transmitter battery holder into the transmitter and re-install the battery door.

❑ 10. Turn on the transmitter using the switch on the back (see the photo with Step 8), The green light on the side of the transmitter should light up. If there is no light on, turn the transmitter off and check to ensure that the battery holder is making contact with the copper contacts on the inside of the battery compartment. Make sure the batteries are installed correctly. Turn the transmitter on and check for the green indicator light. If the green light appears, turn off the transmitter.



❑ 11. Remove the plastic from the outside of the body. Apply the decals if desired. For decal placement, see the photos on the box top.

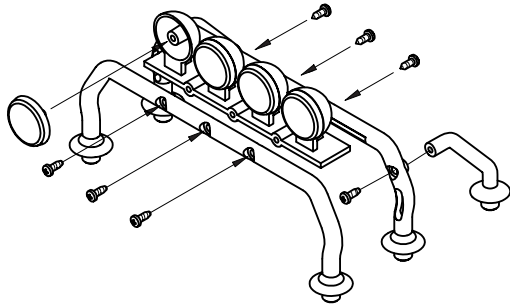

12. Assemble the rollbar as shown using ten 2.6 x 6mm self-tapping screws.

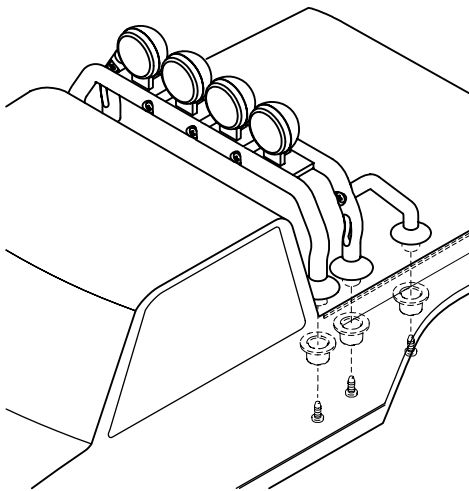

13. Drill six 1/4" (6mm) holes in the body using the molded-in dimples as guides. Install the rollbar onto body as shown using six 2.6 x 6mm self-tapping screws and the included collars.

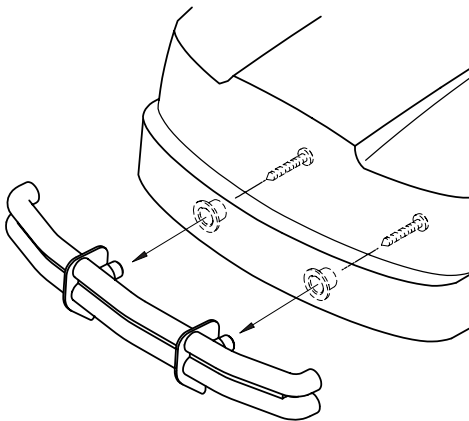

14. Drill two 1/4" (6mm) holes in front of body using the molded-in dimples as guides. Install the front brush guard as shown with two 2.6 x 6mm self-tapping screws and the collars included.

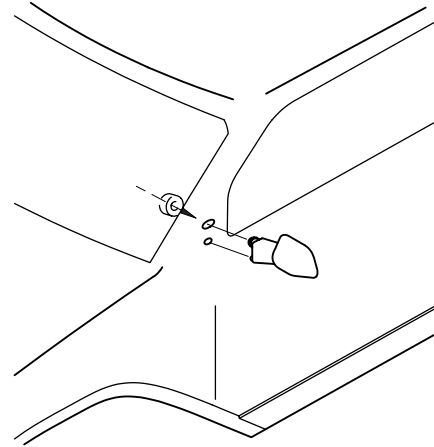

15. Drill one 1/8" (3mm) hole in each side of the body using the molded-in dimple as a guide, and one 5/64" (2mm) hole 7/16" (11mm) below and 7/16" back from first hole (use the pegs on the mirror as a guide). Install the mirrors as shown with the collars provided.



16. Remove the body clips from the parts bag. Place the body on the body mounts. On each body mount place a body clip.

**Congratulations,** you have completed preparations! Before running your new truck, please take the time to carefully read the instructions and watch the video before running and breaking-in the engine. Make sure you follow the safety precautions and most of all...**HAVE FUN!**

## ASSEMBLY OF THE PRE-BUILT VERSION (DTXC0064)

### PREPARING THE RADIO SYSTEM

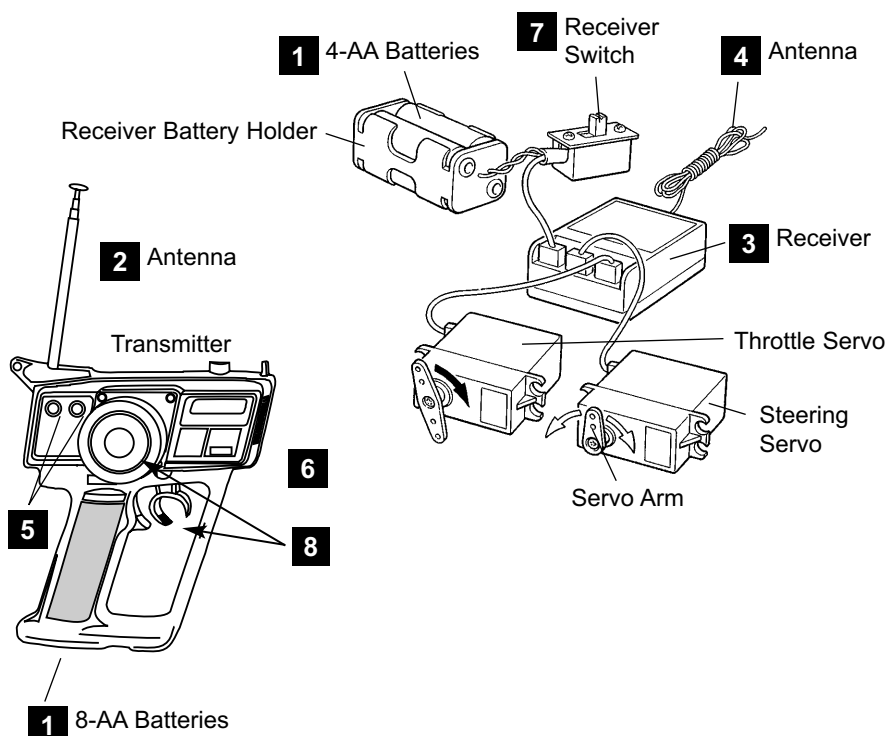

Before installing the radio system in the pre-built DuraTrax Maximum MT, read the manufacturer's instructions manual and follow the instructions shown below.

1. Install the batteries in the transmitter and the receiver battery holders.
2. Extend the transmitter antenna.
3. Connect the steering servo, throttle servo and receiver battery to the receiver.
4. Extend the receiver antenna.
5. Adjust the servo trims of the transmitter to the neutral position.
6. Switch on the transmitter.
7. Switch on the receiver.
8. Operate the steering and throttle control. Make sure the servo arms move in proportion to the movement of the steering wheel and throttle trigger.
9. Switch off the receiver, then the transmitter.

### STEERING SERVO ASSEMBLY

Place a check mark in the check boxes after each step is completed.



1. From bags PA001 and PA003, remove (8) 3 x 8mm self-tapping screws, and the (2) L-shaped servo mounts.

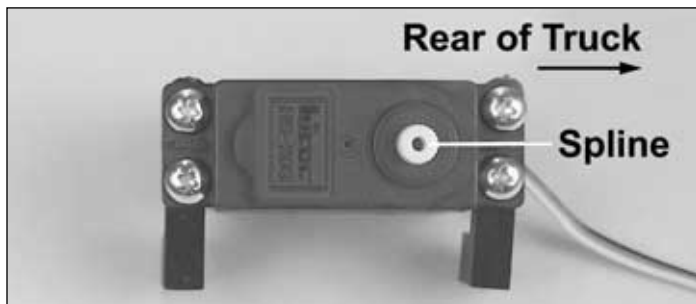

2. Attach the servo mounts to the steering servo with (4) 3 x 8mm self-tapping screws. Note that the servo spline will mount towards the rear of the truck.

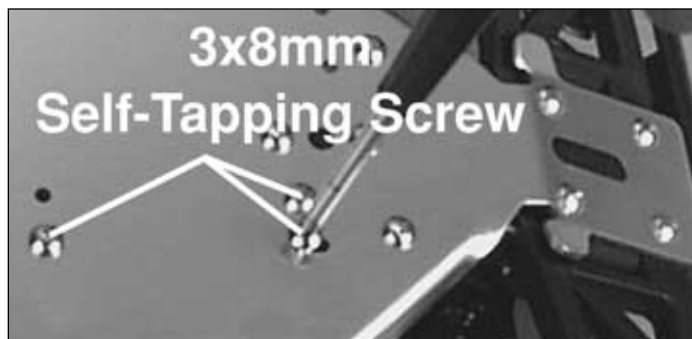

3. Attach the steering servo assembly to the chassis with (4) 3 x 8mm self-tapping screws in the holes provided as shown above.

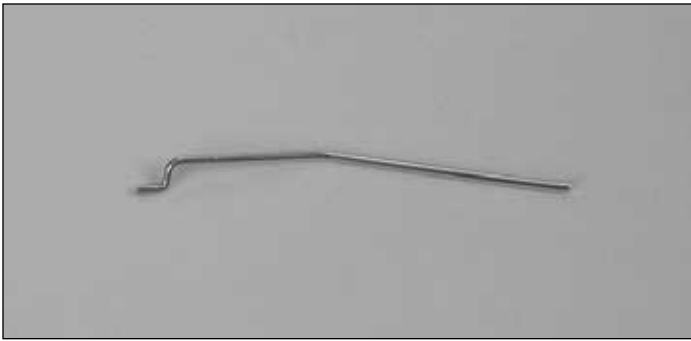

❑ 4. From bag PA001, remove the steering rod. Note the shape of the rod.



❑ 5. Use a 3 or 4 hole servo arm from your radio system. A 1, 2, or 4-armed servo arm will work. Cut off all but one of the arms by scoring both sides of the servo arm with a hobby knife and using pliers to snap off the arm.

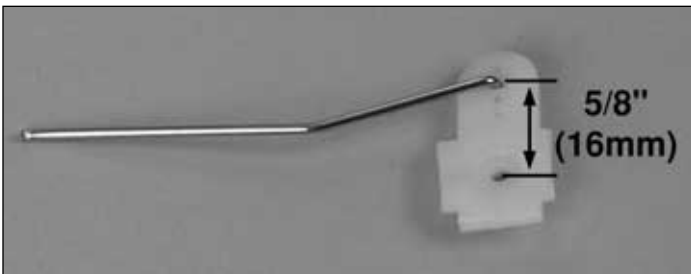

❑ 6. Put the steering rod into the third hole from the center of the servo arm (approximately 5/8" or 16mm). You may need to enlarge the hole in the servo arm with a 5/64" (2mm) drill or a hobby knife.

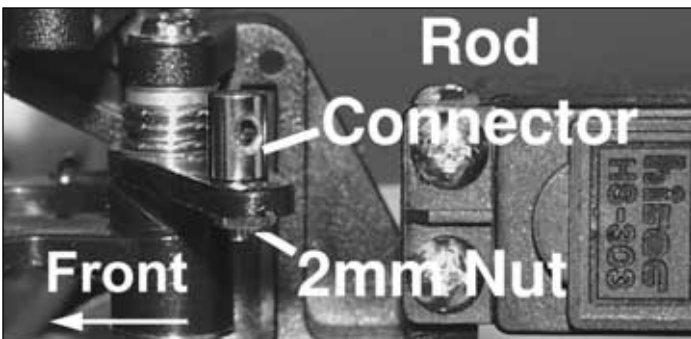

❑ 7. Place the rod connector through the top of the middle hole in the steering arm. Place a small amount of thread locking compound onto the threads of the rod connector. **Do not to overtighten the nut, the rod connector must swivel freely.** Install the 2mm nut onto the bottom of the

connector. Install a 2mm set screw into the top of the rod connector. **Note:** When installing the set screw, make sure not to thread it in too far because the steering rod must pass through the hole on the side of the rod connector.



❑ 8. Slip the steering rod through the hole in the rod connector that is already installed on the servo saver. (Use the screw that came with your radio system to attach the servo arm to the steering servo.) Do not tighten the set screw on the rod connector. You will make the steering adjustments later.

## ASSEMBLING THE RADIO TRAY

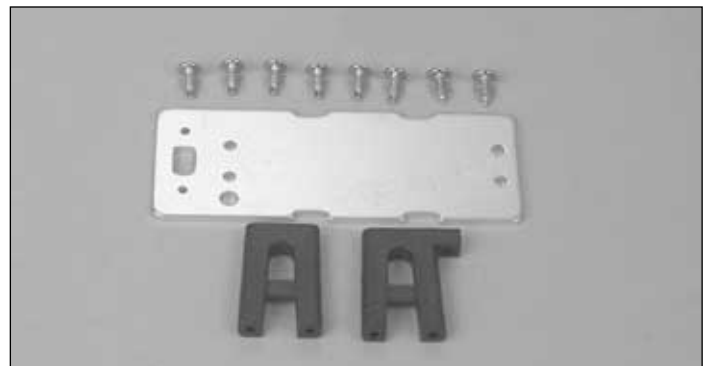

❑ 1. From bag PA002, remove all of the parts included; the radio tray, the (2) radio tray mounts, and the (8) 3 x 8mm self-tapping screws.

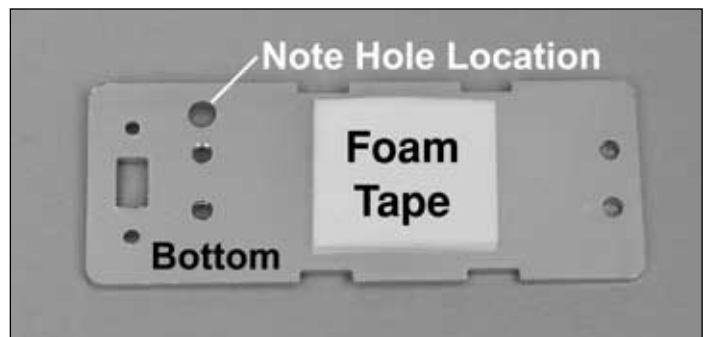

❑ 2. Place foam tape on the bottom of the radio plate. This will secure the receiver battery into place when the radio plate is installed.

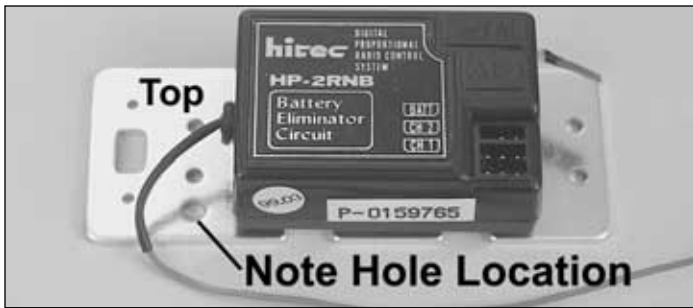

3. Using the provided double-sided tape, attach the radio receiver to the top of the radio tray. To find the top of the radio tray, place the large circular hole to the lower left as shown. Make sure that the receiver is installed in the space between the sets of screw holes as shown above.



4. Attach the switch from your radio system so it is above the top of the radio plate (make sure the switch is in the OFF position). Remove the two screws on the top of the switch. Place the switch plate on top of the radio tray, the switch body on the bottom of the radio tray and then reinsert the screws from the top.

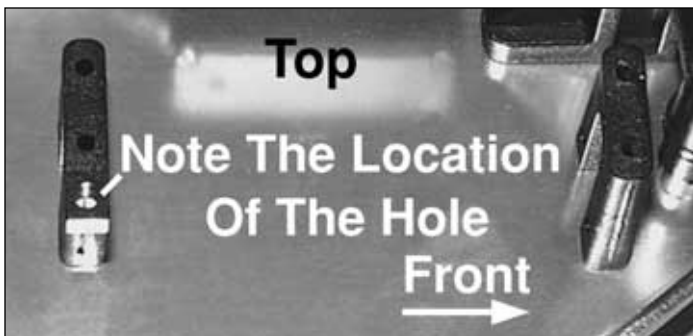

5. Attach the radio tray mounts as shown to the chassis with (4) 3 x 8mm self-tapping screws.



6. Remove from your radio system the 4-cell receiver battery holder and install (4) "AA" batteries (not included). The negative sides of the batteries are placed against the springs in the battery holder. Plug the connector on the receiver battery holder into the connector on the switch. Make sure the switch is in the OFF position. Place the receiver battery holder between the radio plate posts.



7. Plug the steering servo, throttle servo, and switch into the receiver. See your radio instructions to determine which channel is steering and which channel is throttle. The receiver switch plugs into the socket labeled "Battery," "Batt," or "B."



8. Attach the radio tray to the radio tray posts with (4) 3 x 8mm self-tapping screws.

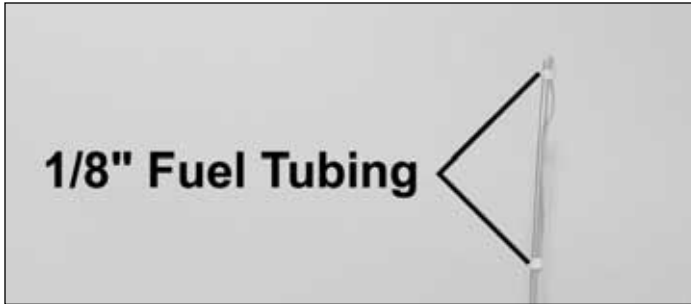
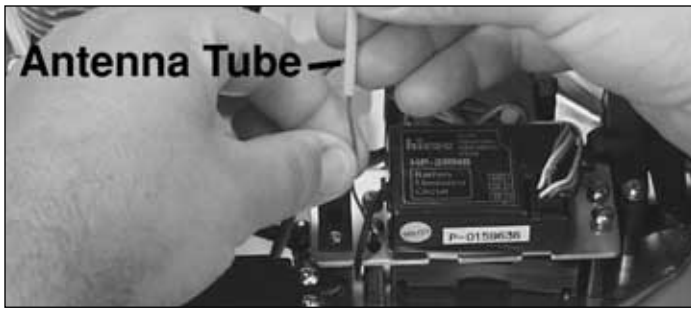

❑ 9. Fit the antenna tube through the radio tray and press fit the antenna tube into the radio tray post. Thread the receiver antenna through the antenna tube. The receiver antenna wire will be longer than the antenna tube. **DO NOT CUT OR COIL THE ANTENNA.** Use tape or cut 1/4" long pieces of fuel tubing to attach the leftover antenna wire to the outside of the antenna tube. Use a hobby knife or drill to cut a hole in the body to route the antenna tube through.

### INSTALLING THE THROTTLE SERVO

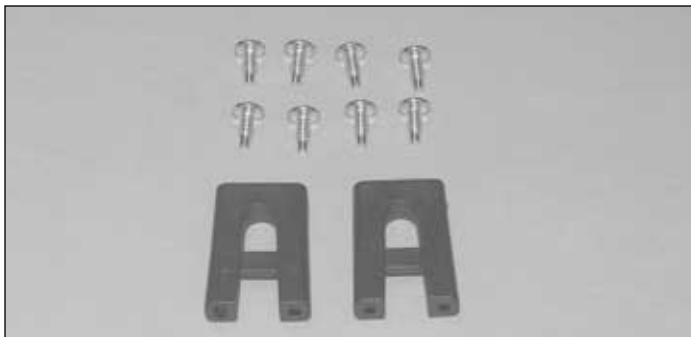

❑ 1. From bags PA001 and PA003, remove the (2) throttle servo mounts and (8) 3 x 8mm self-tapping screws.



❑ 2. Use the (4) 3 x 8mm self-tapping screws to attach the throttle servo to the throttle servo mounts.

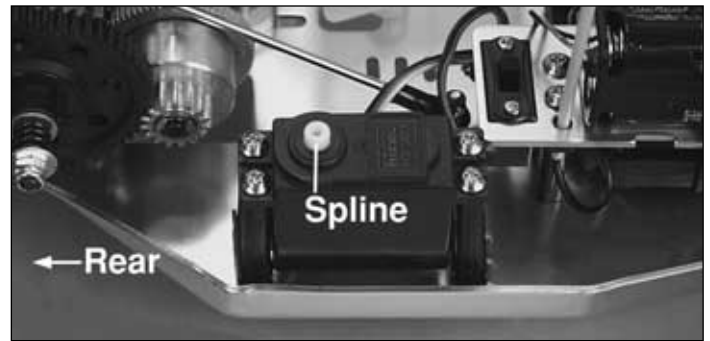

❑ 3. Use the (4) 3 x 8mm self-tapping screws to attach the throttle servo and the mounts to the chassis. Make sure that the servo spline is towards the rear.

### THROTTLE & BRAKE LINKAGES

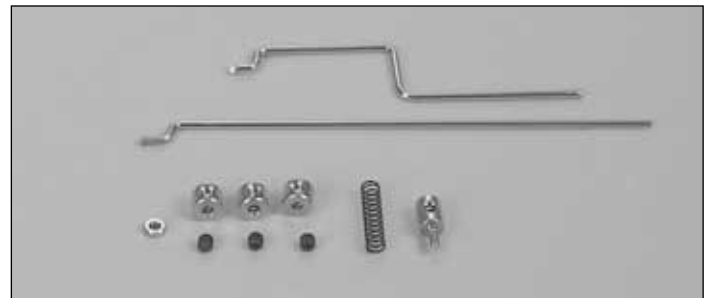

❑ 1. From bags PA001 and PA003, remove the brake rod, the throttle rod, the brake spring, (3) 3 x 3mm set screws, the 2mm nut, the rod connector, and (3) 2mm collars.

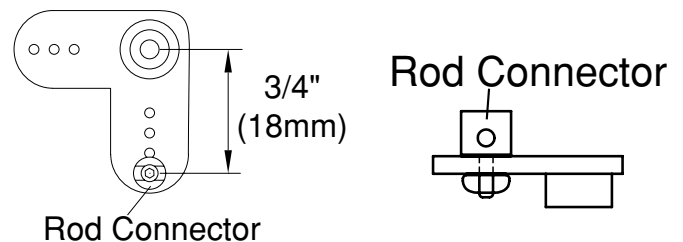

❑ 2. From your radio system remove a large, X-shaped servo arm. Remove two of the servo arms as shown. Install the rod connector in the last hole on the arm as shown in the diagram above (approximately 3/4" or 18mm). You will need to enlarge the hole with a hobby knife or a 5/64" (2mm) drill to fit the rod connector. Apply a small amount of thread locking compound (not included), on the nut to hold it in place. Secure the rod connector to the servo arm with the 2mm nut. Do not tighten the nut completely. The rod connector should swivel easily.

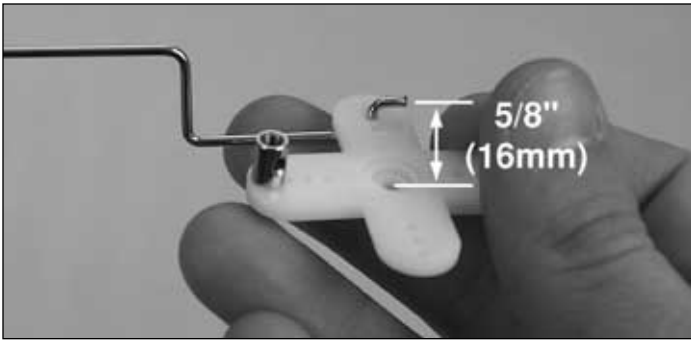

❑ 3. Insert the brake rod as shown in the photo. Insert the brake rod into the servo arm from the bottom, into the second hole from the outside of the arm (approximately 5/8" or 16mm from the center).

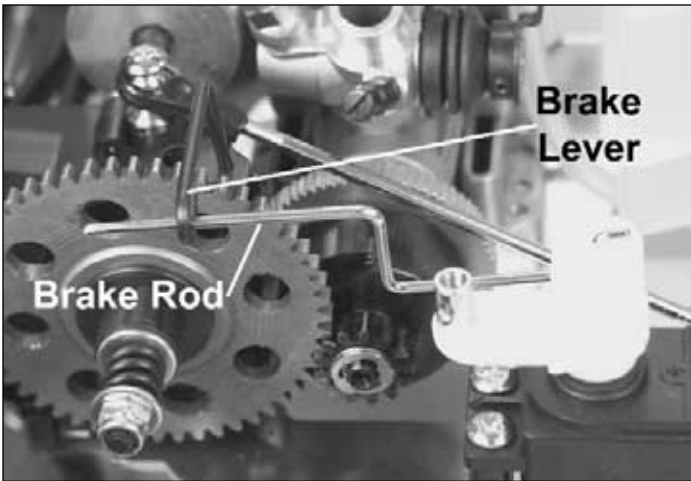

❑ 4. Place the servo arm on the throttle servo as shown in the photo above and place the brake rod through the brake lever. Do not install the servo arm screw yet. You will need to make adjustments before running your truck.

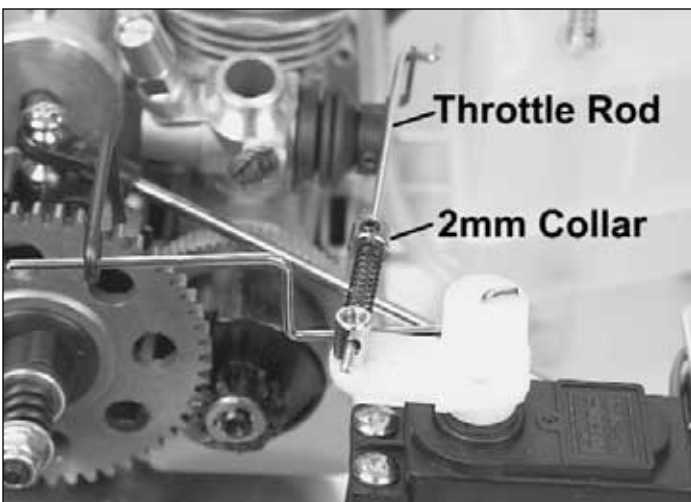

❑ 5. Insert the throttle rod into the outer hole in the carburetor arm. Assemble in order, a 2mm collar and the throttle spring. Next insert the throttle rod through the rod connector on the throttle servo.

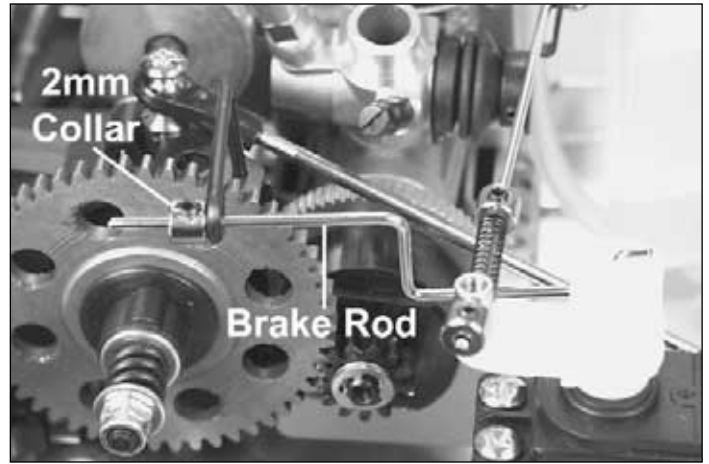

❑ 6. Install a 2mm collar at the end of the brake rod and another 2mm collar at the end of the throttle rod. Place a small amount of thread locking compound on two of the (3) 3 x 3mm set screws and thread them into the 2mm collars. Do not tighten the set screws all the way. In the next section we will make adjustments to the collars.

## RADIO ADJUSTMENTS

- Turn on the transmitter first, then the receiver.
- Center the trims of the throttle and steering channels (see your radio system manual for the location of the trim adjustments).

### *Steering Linkage Set Up*

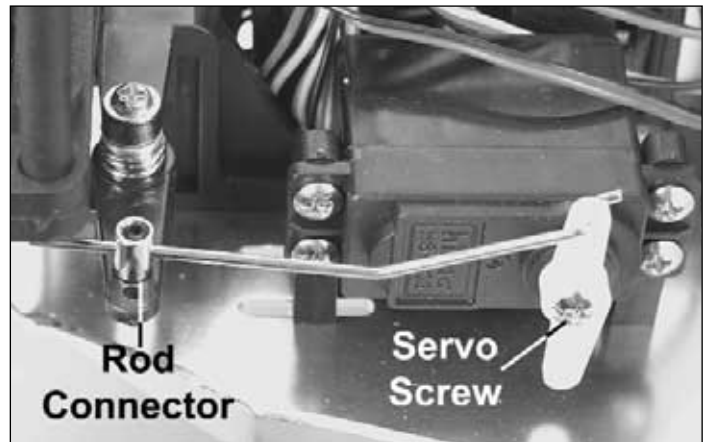

A) Remove the arm from the steering servo and re-install the arm facing straight up (see photo above).

B) Position the front wheels so they are aimed "straight ahead" (note that the tires are aligned slightly inward – this is called toe-in).

C) When the wheels are straight, tighten the set screw on the rod connector. Attach the servo arm with the servo arm screw from your radio system.

## Throttle Linkage Set Up

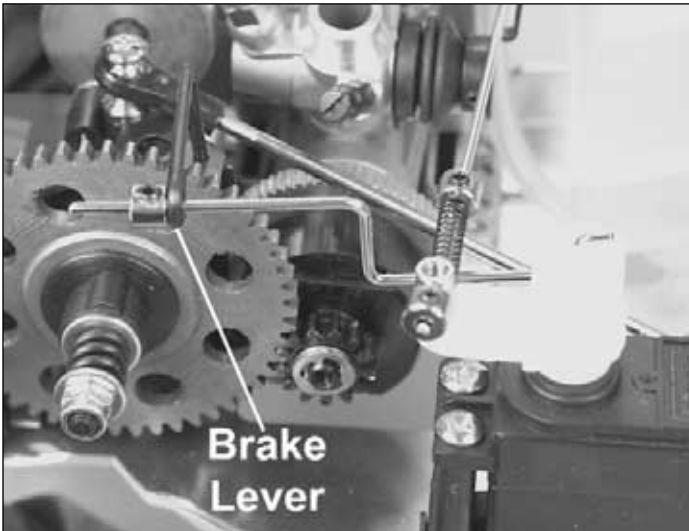

A) With the radio system still on, set the throttle in the neutral position.

B) Remove the servo arm from the throttle and replace the arm so that it is aligned with the centerline of the throttle servo case.

C) The brake lever should be perpendicular (i.e. straight) to the centerline of the chassis as shown above.

D) Tighten the 2mm collar on the brake rod so that it is  $\frac{3}{32}$ " (2mm) away from the brake lever.

E) Push the throttle rod with your finger until the carb closes as far as possible (the carb will not close completely which is normal).

F) Tighten the set screw on the outer collar and cut the throttle rod flush with the outer 2mm collar.

G) Move the throttle spring next to the rod connector.

H) Tighten the inner 2mm collar next to the throttle spring without compressing the spring.

I) Attach the throttle servo arm with the screw included with your radio system.

## PREPARE THE ENGINE



1. Remove the fuel tank by taking out the two screws on the bottom of the chassis.



2. Remove the fuel line, air cleaner, and tie-strap from the parts bag.

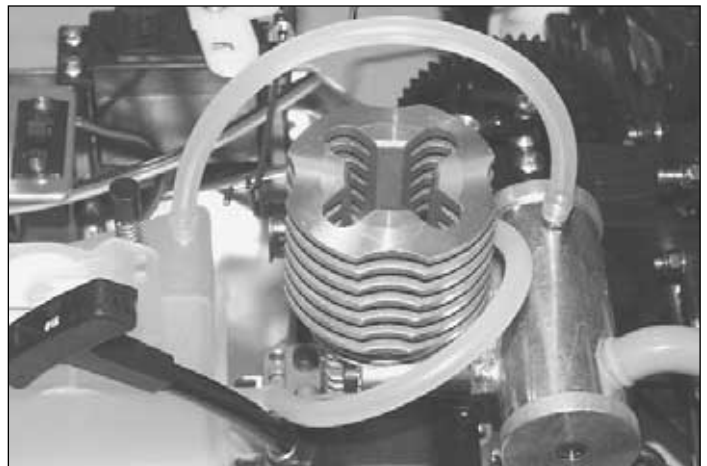

3. Cut the fuel line in half. Route one of the lines from the nipple on the top of the muffler to the top of the fuel tank. Route the other fuel line from the nipple on the carburetor to the bottom of the fuel tank. Ensure that the fuel line is not kinked anywhere along the line. You may have to shorten the line to eliminate kinks.



❑ 4. Re-install the fuel tank.



❑ 5. Remove the air filter and tie strap from the parts bag. Thoroughly soak the air filter foam with some oil (not included) and then squeeze out the excess oil. A light machine oil (like 3-IN-ONE) will work well. Special oils made for air filters are also available in most hobby and motorcycle shops. Place the air filter onto the carburetor and secure it in place with the tie strap. Cut off the excess part of the strap.

## FINISHING

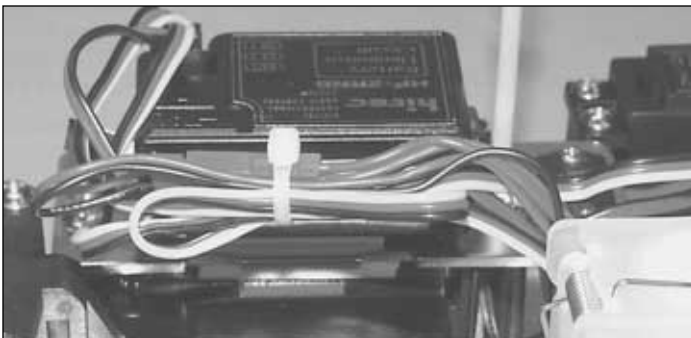

❑ 1. Bundle all of the wires around the receiver together with a tie-strap or a twist-tie (not included in the kit).

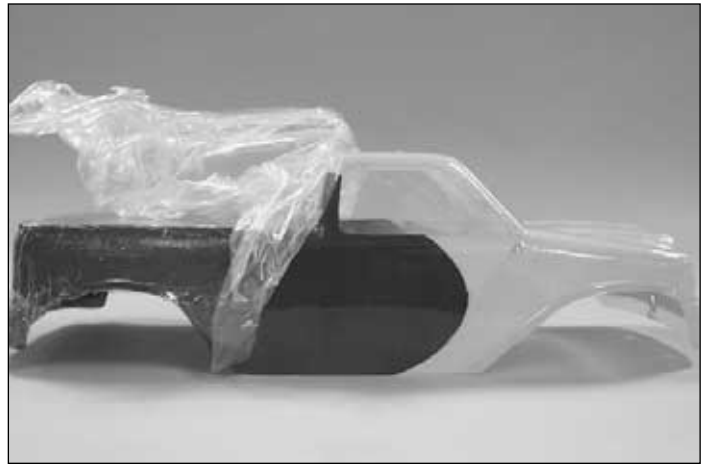

❑ 2. Remove the clear covering from the outside of the body. Apply decals to the body if desired. For decal placement, see the photos on the box top.

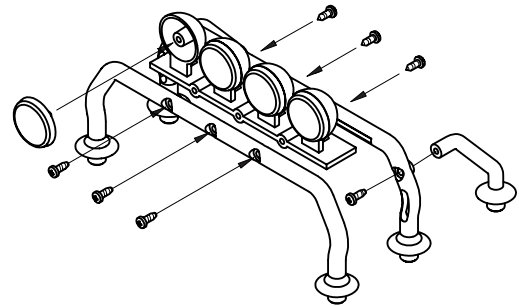

❑ 3. Assemble the rollbar as shown using ten 2.6 x 6mm self-tapping screws.

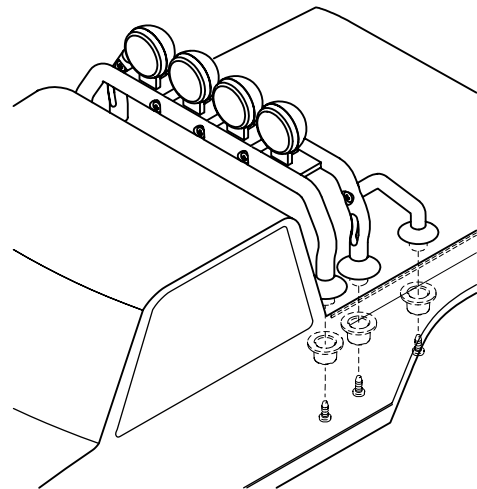

❑ 4. Drill six 1/4" (6mm) holes in the body using the molded-in dimples as guides. Install the rollbar onto body as shown using six 2.6 x 6mm self-tapping screws and the included collars.

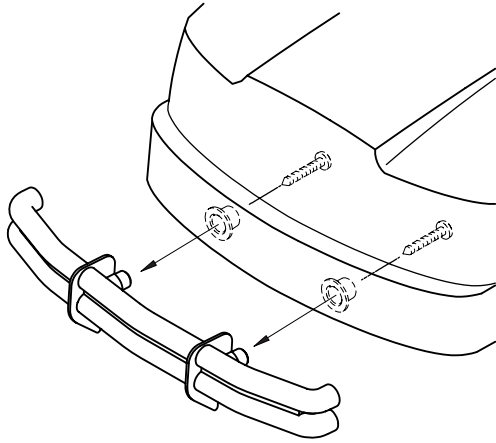

❑ 5. Drill two 1/4" (6mm) holes in front of body using the molded-in dimples as guides. Install the front brush guard as shown with two 2.6 x 6mm self-tapping screws and the collars included.

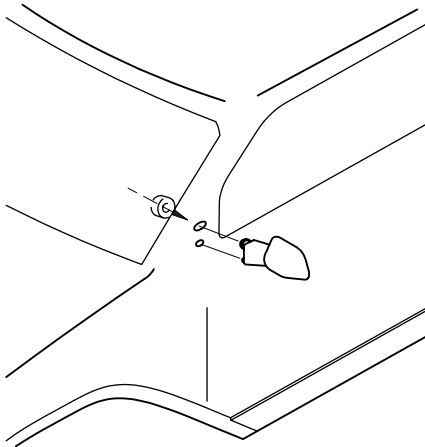

❑ 6. Drill one 1/8" (3mm) hole in each side of the body using the molded-in dimple as a guide, and one 5/64" (2mm) hole 7/16" (11mm) below and 7/16" back from first hole (use the pegs on the mirror as a guide). Install the mirrors as shown with the collars provided.



❑ 7. Mount the body on the body posts and secure the body to the truck with (4) body clips.

**Congratulations**, you have completed assembly! Before running your new truck, please take the time to carefully read the instructions and watch the video before running and breaking-in the engine. Make sure you follow the safety precautions and most of all...**HAVE FUN!**

## CARBURETOR SETTINGS

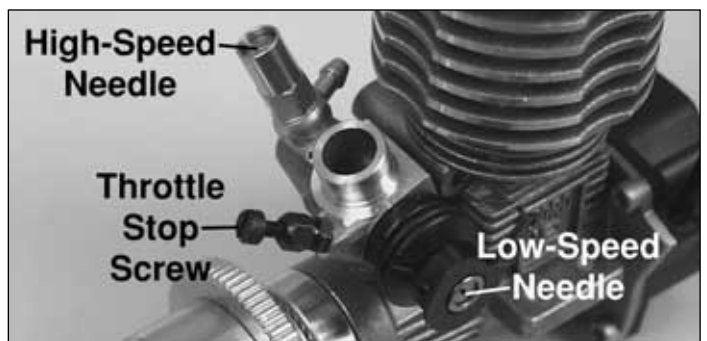

### The High-Speed Needle

The "high-speed" needle is sticking up from the side of the carb. It is located in the brass housing, just above the fuel inlet. It controls the fuel to air mixture of the carb. The needle is pre-set for break-in from the factory at 2-3/4 turns out from the fully closed position of the carb. Once the engine is broken-in, the high-speed needle would typically run from 2 to 2-1/2 turns out from closed, depending on the weather, humidity and altitude above sea level. To richen turn the needle counterclockwise, to lean turn the needle clockwise.

### The Low-Speed Needle

The “low-speed” needle is the screw in the middle of the throttle arm. It controls the fuel to air mixture at low throttle settings. There is a simple way of adjusting the low-speed needle correctly called the “pinch test.” With the engine at idle, pinch the fuel line and listen to how the engine speeds up or slows down. If the engine increases its speed for about 2 or 3 seconds and then loses speed, the needle is set correctly. If the engine loses RPM quickly, it is set too lean and the low-speed needle needs to be opened (**counterclockwise**) to richen the mixture. Pinch again to check the mixture. If the engine takes longer than 4 seconds to slow down, lean (**clockwise**) the low-speed needle and then pinch again to check the mixture.

### The Throttle Stop Screw

On the front of the carburetor, there is a black screw. This is called the idle stop screw. This increases or decreases the idle RPM without changing the fuel to air mixture. The barrel should be approximately 1.5mm (between 1/32" and 1/16") from fully closed.

## BREAKING-IN THE ENGINE

To insure long life and good performance from your Torq .16 engine, you **MUST** break-in the engine. The break-in period is critical for long life of the internal parts of the engine. This should be done over the first 4 or 5 tanks of fuel.

### Some Things To Remember During Break-In

1. Run with the body off. This will keep the engine cooler.
2. Keep the air cleaner on at ALL times
3. Run on a smooth, hard surface. An empty parking lot is perfect.
4. Use the same fuel that you will use for normal running.
5. Resist the urge to accelerate and decelerate the truck quickly.
6. Break-in puts stress on the glow plug and you can burn it out during break-in. Make sure you have an extra plug or two on hand.
7. Do NOT overheat the engine. You can check the head temperature by using one of the temperature gauges that are available or by putting a drop of water on the top of the cylinder head. If the water boils away immediately, shut off the engine and allow it to cool. If it takes more than 5 seconds to boil away, the engine is at proper running temperature for break-in.

## RUNNING THE ENGINE

Before running the engine, read the manual and watch the engine video that came with this kit.

### There are several simple steps to starting the engine:

1. Install a glow plug. This threads into the top of the cylinder head.
2. Fill the tank - Fill the tank almost to the top. Leave a little air at the top of the tank.
3. Prime the engine - Use the primer button on the fuel tank to force the fuel through the fuel line. Watch the fuel go through the line and when it gets to the carburetor, press the primer button once more to get fuel into the engine.
4. Open the high speed needle valve exactly 2-3/4 turns out (**counterclockwise**) from fully closed. **The high-speed needle is sticking up from the carburetor inside the brass housing.** All of the carburetor settings are adjusted with a flat bladed screwdriver. If you have previously run the truck, keep the same needle valve setting that you used on your last run.
5. Start the engine by pulling the recoil - Use short, quick pulls. **DO NOT** pull the recoil starter's string to the end. You only need 10 to 12 inches of pull to start the engine.

Sometimes it is helpful to start the engine at around half throttle. Have a friend pull back on the throttle some while you start the engine. This *may* be an indicator that the low speed needle setting needs to be adjusted. When the engine starts, immediately return the throttle to idle. If this is not done the engine can over-rev and cause engine damage. **If the engine is difficult to turn over with the recoil starter, especially if it is brand new, loosen the glow plug a half turn before starting the engine. This allows some compression to escape, but the engine will still start. Make sure you tighten the glow plug after the engine starts.** If the recoil starter is still difficult to pull, the engine is flooded – there is too much fuel inside the engine. Remove the glow plug and air cleaner, then turn the engine upside down and pull the recoil 5 or 6 times. This will clear the engine of fuel, and you will notice the recoil pulls easier. Replace the glow plug and repeat the starting procedure.

### Fuels

Use fuels that are specially formulated for car and truck engines. DuraTrax Red Alert fuel is specially formulated for truck engines like the Torq .16.

### How To Stop Your Engine

You may have been wondering how to stop the engine. All you have to do is pinch the fuel line that runs to the carburetor and from the bottom of the fuel tank. Pinching this will restrict the fuel flow and the engine will quit within a few seconds.

## The First Tank

Your first tank of fuel should be running the truck at a very rich high-speed needle valve setting. This allows the fuel to carry as much oil as possible into the engine to lubricate the internal parts during the break-in.

1. Open the needle valve 2-3/4 turns from fully closed (counterclockwise). This is factory set already, but check it to make sure. When closing the high-speed needle, close the needle until you feel some resistance. **DO NOT** overtighten or you will damage the engine.
2. Start the engine.
3. Once the engine is started, open the high-speed needle valve around 1/8 turn at a time, finding the setting where the engine just barely runs. This may take a few times adjusting the needle, running the truck away from you and back, then adjusting the needle. The truck will perform sluggishly and stall from time to time - that is normal.
4. Run the truck back and forth at medium speeds, slowly accelerating and decelerating the truck.
5. After a minute or two of running, make sure the engine is not overheating by putting a drop of water on the cylinder head and watching it boil away. If it boils away immediately, stop the engine and allow it to cool. Open the high-speed needle around a 1/4 turn before starting again. This is a good habit to get into every time you run to ensure that the engine does not overheat during any run. Looking at the smoke that comes out the exhaust is also an indicator of how rich or lean the engine is running. If there is a good amount of smoke coming out of the exhaust, then chances are good that you are running rich.
6. Run the truck back and forth at a medium speed until the tank is almost out of fuel. Do not allow the tank to run out of fuel. This leans out the engine and can cause overheating (See How To Stop Your Engine).
7. Stop the engine and allow the engine to cool before the second tank. This normally takes around 10 minutes.

## Tanks 2-5

Turn in the needle valve (clockwise) around 1/12 turn from the previous setting. Run the truck back and forth. You should notice that the truck will perform better during each run. Stop the truck periodically to check for overheating. If it is too hot, stop the engine. Wait for it to cool, then open up the needle valve and restart. After the 5th tank, you should be near to the peak performance of the engine.

## ENGINE MAINTENANCE

### 10 Ways To Ensure A Long Life From Your Engine:

1. Keep your engine clean. Dirt will act as insulation on an engine. It will not be able to shed heat as easily. Use a good air filter to keep dirt out of your engine and clean it often.
2. Do not over-lean your engine.
3. Do not run your engine with little or no load. Don't throttle up the engine to full throttle when the wheels are not in contact with the ground.
4. Do not overheat the engine. This goes along with keeping it clean and not over-leaning the engine.
5. Do not use a fuel with a low oil content. Make sure you use a fuel from a reputable manufacturer, such as DuraTrax Red Alert.
6. Avoid using old fuels in the engine. Always run all of the fuel out of the engine. After running for the day, use an after-run oil and work it into the engine by turning the flywheel or pulling the engine recoil slowly.
7. Do not use a fuel with a nitromethane (often called nitro) content over 20%.
8. Do not scratch the piston or cylinder sleeve. Avoid jamming something into the exhaust port when removing or re-installing the clutch or flywheel. Use a special tool called a crankshaft locking tool, which is installed in the glow plug hole.
9. Do not use silicone sealer on the engine joints. Silicone sealer contains acetic acid, which is corrosive if it gets inside your engine.
10. Do not allow any water inside the engine. This sounds easy, but temperature changes can cause condensation inside the engine. This is a good reason to use an after-run oil. Store your engine inside the house, not in a garage or shed where there will be temperature extremes.

***If you are having problems with your engine consult the engine troubleshooting flow chart on page 16. The following are some potential problems.***

### Glow Plug

The glow plug is an item that will wear out and need replacement from time to time. It is a good idea to remove the glow plug before your first run, heat it and see how well it glows. You should see a bright orange glow from the filament. If a coil or two will not glow or the plug will not glow at all, replace the plug. If the engine quits when you remove the glow starter, the plug might need to be changed, although this may be because you are running too rich and need to screw in your high-speed needle some. Look at the glow plug when you are running the engine. If you see some bubbles coming from around the plug, replace the glow plug (copper) gasket, or both the plug and gasket. The only real way to test a glow plug is to replace it. Make sure you have a spare plug or two on hand every time that you run the Maximum MT.

## Fuel

Fuel can go bad. The main ingredient in model fuel is methanol, which is basically an alcohol. Alcohols can absorb water out of the air, so keep your fuel jug capped at all times. Store your fuel out of the sunlight and in a cool place. Bad fuel is one of the most difficult problems to diagnose in engines. If you have tried everything you can think of to remedy an engine that is not running correctly, try using some fresh fuel.

Fuel line is susceptible to pinhole leaks. You cannot see the hole in the fuel line, but if you see air bubbles in the line going to the carburetor, replace the fuel line. Another symptom of a leak in the fuel line is a surging engine. The properly tuned engine will surge when the air bubbles hit the carb. It is basically leaning out the mixture.

To keep dirt out of the engine, we recommend that you use an inline fuel filter on the fuel line running from the fuel tank to the carburetor. Dirt can get caught in the needle seat and cause an inconsistent running engine. If you suspect that some dirt has lodged itself in the carb, remove the needles and clean the carb with denatured alcohol or fuel. It can help to use compressed air to blow out the fuel passages as well. Dirt can get into your carburetor and engine through the air filter. Ensure that your air cleaner has a good seal to the top of the carb. Periodically wash the air cleaner foam element and re-oil the filter. Any air cleaner that has a torn element or a bad seal should be replaced immediately.

## Overheating

One of the worst things you can do to your engine is overheat it. The oils that lubricate the engine are carried in the fuel. If your engine is set too lean, there will not be enough oil in the engine to lubricate the internal parts. This will cause premature wear in the engine and cause damage. We have talked about overheating in other parts of this manual, but we want to stress the proper techniques to check for overheating. The easiest way of checking the temperature of the cylinder head is using one of the available temperature gauges. This will give you a direct reading of the cylinder head temperature. Do not let the head temperature exceed 220° Fahrenheit (104° Celsius). Another way of checking the head temperature is to put a drop of water on the cylinder head. If it boils away immediately, the high-speed needle is set too lean. If the water boils away in 3-5 seconds, the engine is within proper operating temperatures. If the water boils away longer than 5 seconds, the mixture is set rich which is preferable when breaking in the engine. Otherwise lean the mixture some and retest after a minute of running.

## PERFORMANCE TUNING

*Ride Height:* This refers to the clearance between the ground and the chassis, both at the front and the back of the truck. The ride height on the Maximum MT should be approximately 2-3/8" (60mm). To determine the ride height, drop the truck from around 6"-12" above flat ground. Drop the truck, making sure it drops flat. Check where the suspension arms come to rest. You can adjust ride by moving the spring adjusters on the shock (which are at the top of each shock spring) until the appropriate height is achieved after the drop test.

*Toe-In/Toe-Out:* This refers to the angle of the front tires when viewed from above when the suspension arms are level. If the fronts of the tires angle in, it is called "toe-in" and if the fronts of the tires angle out, it is called "toe-out." This is adjusted by turning the steering rods - the rods that run between the front hub and the servo saver. These are turnbuckle type, which means you do not have to remove the rods to make adjustments in length. Turning the rod in one direction will lengthen, turning the rod the opposite direction will shorten. Normally a small amount of toe-in is used to make the truck track straight at high speed. Too much toe-in will make the truck difficult to turn as well as reduce the overall top speed because of tire scrub. Sometimes a small amount of toe-out will be used to help the steering. As a general rule use a small amount of toe-in.

*Camber:* Camber is the angle of the tops of the tires when viewed from the front. Negative camber is when the tops of the tires are angled towards the center of the truck. Positive camber is where the tops of the tires are angled away from the center of the truck. Positive camber is very rarely used, if ever. A small amount of rear negative camber is helpful to increase traction in the rear. Negative camber at the front will increase stability. Camber adjustments can be made on the Maximum MT by turning the "camber rods," which are the upper links on the suspension. The camber links are also turnbuckle type. Lengthening the camber rod will add positive camber and shortening the camber rod will add negative camber.

## MAINTENANCE TIPS

### Before Each Run

- Check for loosened screws on the truck. Engine vibration will loosen some of the screws, particularly in the engine mount area. Use thread lock on screws that thread into metal parts or use a metal nut.
- Inspect the air cleaner for a torn or damaged element. Also look for dirt in the air cleaner element and wash it if necessary.
- Check the suspension and drive train for binding.
- Inspect all of the wires for damage. Also check the connectors to make sure all of them are tight and in the proper place.
- Check the fuel tank and fuel lines for leaks.
- Before starting the engine, turn on the radio and make sure the servos move easily and in the right direction.
- Before running always check the condition of your radio system batteries and replace/recharge if necessary.

### After Each Run

- Drain the fuel tank of any leftover fuel. **DO NOT** return it to your fuel jug.
- Put some after-run oil in the carb and turn the flywheel several times to work the oil into the engine. This will protect the engine from rusting, especially when stored for a long period of time.
- Check again for loosened screws.
- **CLEAN** the truck. Wipe off any oils that have collected on the chassis, engine end exhaust. Oils will attract dirt on the next run.

*Shocks:* Changes in shock oils, springs, and pre-load on the springs can dramatically change the way the car handles. A thicker shock oil will make the truck turn faster but reduces overall traction and handling over bumpy surfaces. Thinner oil will increase traction at the expense of steering response and the car will tend to roll more. In general, shock oils between 20 and 40 weight will be best for your truck. You should experiment some to see what oils work best for your track and driving style. Shock springs affect the rate that the suspension rebounds from a bump. We have supplied soft springs that work under most conditions. Other springs are available from DuraTrax. Pre-load on the springs means that the springs are already compressed some so that the suspension will rebound faster. Sometimes you will want to pre-load one side when the track has turns all or mostly in one direction, for instance an oval track. It will also increase the ride height.

*Slipper Clutch:* The slipper clutch is attached to the spur gear on your truck, the large gear on the outside of the transmission. This clutch will slip when too much power is sent to the wheels. It has adjustable tension by turning the nut on the shaft. This is designed to maximize traction on various surfaces by slipping before the wheels do. To adjust the slipper clutch, run the truck on the surface you plan to race. If the rear wheels spin when full power is applied from a stop, loosen the nut until the wheels do not spin any more. If the wheels do not spin, tighten the nut until the wheels spin and then loosen the nut some.

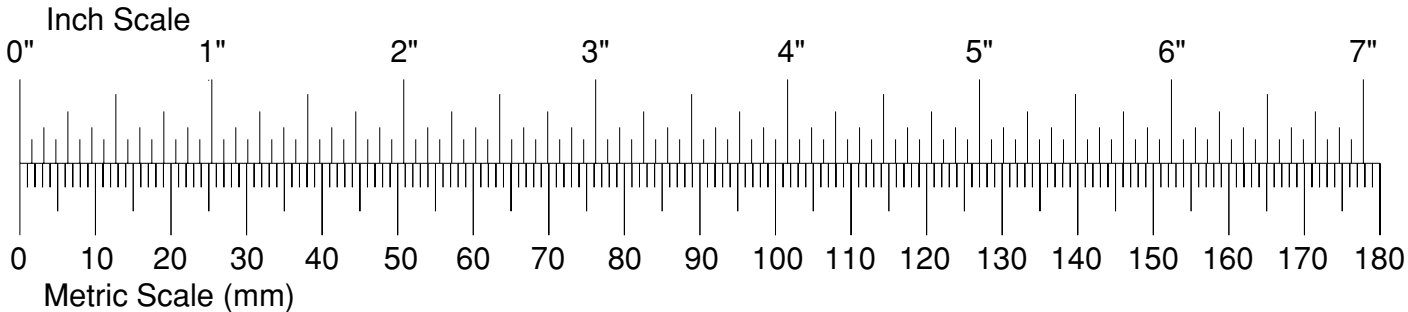

# ENGINE TROUBLE SHOOTING

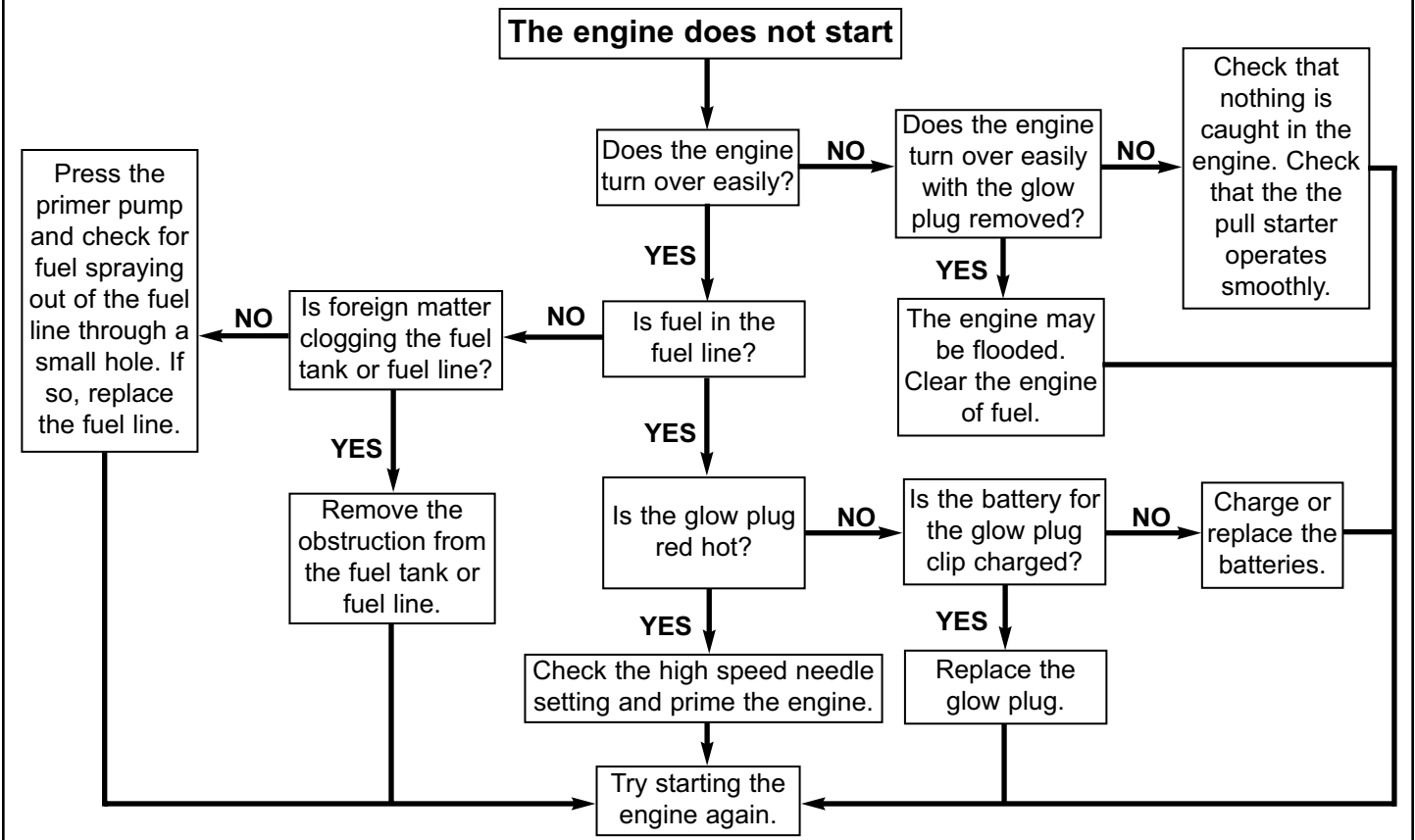
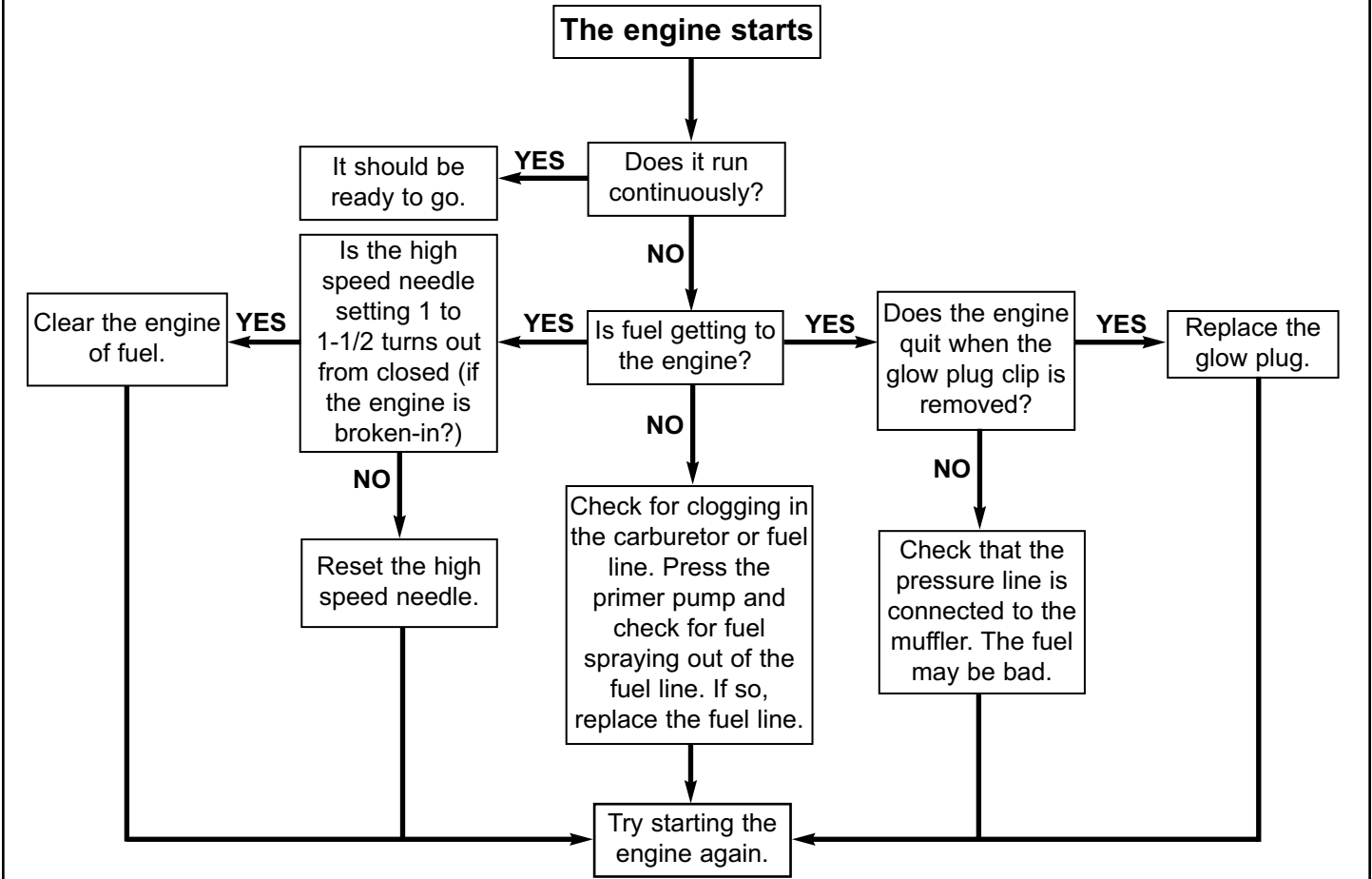

## RECOMMENDED ACCESSORIES



**DuraTrax 4-Shoe Clutch Kit**

Tweak your Maximum MT for amazing acceleration! This kit increases surface area compared to 3-shoe clutch designs for an improved clutch bell grip. Requires bearings (DTXC1535) and clutch bells (DTXC2521-DTXC2526). **DTXC2541**



**DuraTrax Bearing Completer Set**

Reduce friction, drag and extend the life of your Maximum MT's parts with this ball bearing set. Includes all sizes needed to replace the bushings included with your Maximum MT. **DTXC2541**



**DuraTrax Kwik-Pit™ 500cc Fuel Bottle**

Fast, clean pit stops are as close as the Kwik-Pit Fuel Bottle. The long, angled neck reaches easily into your tank to prevent fuel spills, the clear plastic body keeps the fuel level in plain sight and moving fuel from the bottle to your tank takes just a gentle squeeze. **DTXP0150**



**DuraTrax Deluxe Glow Plug Wrench**

This single, heavy-duty, plated steel tool handles FIVE metric hex sizes: 7-, 8-, 10-, 12- and 17mm—and includes a special 10mm socket for pilot shafts! Threaded holes tapped between the wrenches store up to four spare plugs. **DTXR1170**



**DuraTrax Red Alert™ 20% Racing Fuel**

To make your TORQ™ 21 engine run faster, better and longer, you need the unique formula of DuraTrax Red Alert. Red Alert contains 20% nitro plus a carefully race-tested blend of castor and synthetic oils. **DTXP0600**



**DuraTrax Nitro Starter Set**

This set includes everything you need to start racing. 5-way glow plug wrench, 1 qt. of Red Alert fuel, Hobbico® glow starter w/charger, fuel bottle and glow plug. **DTXP0200**



**DuraTrax XL Field Bag**

Keep your gear loaded and race ready with the XL field bag. Heavy duty black nylon bag with red trim and white logo. **DTXP2000**



**DuraTrax Body Repair Tape**

Need a quick, easy fix for Lexan® body damage? When used with Shoe Goo II fixit compound (DTXC2460), the tape's open weave, nylon mesh design offers enough flexibility to prevent future cracking. **DTXR1210**



**DuraTrax Crankshaft Locking Tool**

Remove your engine's clutch safely with this easy to use, anodized metal tool. Works with all .10 to .21 car and buggy engines. **DTXR1100**